



PEER REVIEWED
01512Y

4-H Cooking

101



UNIVERSITY OF ILLINOIS
EXTENSION





ACKNOWLEDGEMENTS

Written by:

Madonna Weese, Ed. D., Extension Specialist 4-H Youth Development
Shirley Camp, MS, RD, Nutrition and Wellness Educator
Barbara Farner, MS, Nutrition and Wellness Educator
Jananne Finck, MS, RD, Nutrition and Wellness Educator
Kelly Pool, MPA, Youth Development Educator
Paula Robinson, MS, Macoupin County Extension Director
Carol Schlitt, MS, CFCS, Nutrition and Wellness Educator
Sarah Todd, MS, RD, Nutrition and Wellness Educator
Alyssa Cole, 4-H member

Graphic Design by: Paula Wheeler, www.WheelerArts.com
Illustrations with copyright symbol: QuickArt © by Wheeler Arts

All recipes in this book were tested by University of Illinois Extension Nutrition and Wellness Educators.

- Recipes were analyzed using The Food Processor SQL, Version 10.0.
- 2% milk was used unless another kind of milk was specified in the recipe.
- When a range was given for ingredient amount or number of servings, the largest number was used in the analysis.
- When options were listed for ingredients in a recipe, the first ingredient listed was analyzed.

Codes for Nutrition Facts: g = gram and mg = milligram.

For ordering information contact National 4-H Council Supply Service at: (301) 961-2934 or www.4-Hmall.org.



UNIVERSITY OF ILLINOIS
EXTENSION

© Copyright 2015 University of Illinois Board of Trustees

University of Illinois College of Agricultural, Consumer and Environmental Sciences
• United States Department of Agriculture • Local Extension Councils Cooperating

Urbana-Champaign, Illinois

01512Y

February 2015

Issued in furtherance of Cooperative Extension Work, Acts of May 8 and June 30, 1914, in cooperation with the U.S. Department of Agriculture, GEORGE CZAPAR, Director, University of Illinois Extension. University of Illinois Extension provides equal opportunities in programs and employment. *The 4-H Name and Emblem are Protected Under 18 U.S.C. 707.

4-H Cooking 101

TABLE OF CONTENTS

A Note to the Project Helper	4
Project Planning Basics	5
Kitchen Basics: What Do You Know?	6
Explore MyPlate	8
Food Safety Basics	13
Kitchen Safety Basics	15
Demonstrate Your Knowledge on Kitchen Safety Basics	18
Experiment! Testing For Microwave-Safe Dishes	19
Meal Time Basics	20
Measuring Basics	22
Experiment! How Much Flour Will a Measuring Cup Hold?	26
Cooking "How To" Basics	28
Demonstrate Your Knowledge on Cooking "How To" Basics	32
Recipes	33
■ Snacks	33
■ Side Dishes	40
■ Main Dishes	48
■ Quick Breads	54
■ Desserts	62
Nutrition Facts	75
Recipe Index	80
Equipment Basics	81
Glossary	83



A NOTE TO PROJECT HELPERS



The *4-H Cooking 101* project was developed for young people who are just learning to cook and bake. The project covers kitchen and food safety, basic food preparation, and nutrition. You have a very important role as the Project Helper. Many of the activities and recipes in this project require the help of an adult or older youth. Your responsibility is to guide, assist and mentor the young person in the project, but it is important to allow the youth to complete the activities and recipes themselves. Cooking is an art as well as a science so youth can learn from your experience and his/her practice.

Learning by doing is the best way to learn food preparation skills. Young people will learn important life skills that they will use as they grow and become independent, responsible adults. Instead of always telling the youth the right answer or the correct way to do something, ask the young person what he/she thinks and allow the youth to learn from trial and error. With support from you as a caring person, he/she will remember these lessons and the impact that you had on his/her life.

As you work with the young person on this beginning foods project, remember to focus on the positive. If the youth doesn't do things quite the way you would, compliment on what is done well rather than criticizing. If something doesn't turn out right, use that as a learning opportunity to find out what the youth might do differently next time. Your positive feedback and encouragement as the Project Helper is important to the youth.



PROJECT PLANNING BASICS

Welcome to *4-H Cooking 101*. In this project you will learn many skills that every good cook needs. It may take two or three years for you to complete *4-H Cooking 101*. When you are finished you will have a good foundation for preparing many of your family's favorite dishes and snacks. You have over 40 different recipes to choose from and several learning activities to complete as part of the project.

It is important to have a project helper to guide you through the things you will learn in this project. Your helper can be a parent, grandparent, club leader, or another adult or older youth who has experience in food preparation and safety. Show the person your project book and ask if he/she would be willing to help you with the project. Ask your helper to complete the following information:

My Project Helper _____

Phone number _____ E-mail address _____

For each year of the *4-H Cooking 101* project you should:

- Prepare 2 to 3 dishes from **each** of the recipe sections: snacks, side dishes, quick breads, main dishes, desserts (10 to 15 dishes total)
- Complete 2 learning activities
 - Explore **MyPlate** Activity
 - Demonstrate Your Knowledge on Safety Basics
 - Experiment: Testing for Microwave-safe Dishes
 - Experiment: How Much Flour Will a Measuring Cup Hold?
- Demonstrate your knowledge on Cooking “How To” Basics. Give 3 to 5 “How To” demonstrations to your helper, leader or club.
- Complete at least one community service project such as baking food for a charity bake sale.



KITCHEN BASICS: WHAT DO YOU KNOW?



Following is a list of the skills you will learn in *4-H Cooking 101*. Before you start working on the project, read through the list of skills and rate yourself on how much you know now. Then **at the end of each project year**, rate what you know about the cooking skills you have practiced.

Use the following rating scale: Begin each statement with the phrase, "I know how to..." then circle 1 = not at all; 2 = a little; 3 = a lot

My plate.

I know how to...	Before	After
Use MyPlate to eat a daily balanced diet	1 2 3	1 2 3
Avoid spreading germs while I am cooking	1 2 3	1 2 3
Properly and safely use small appliances for cooking	1 2 3	1 2 3
Properly and safely use the range when cooking	1 2 3	1 2 3
Properly and safely use the oven when baking	1 2 3	1 2 3
Safely use a knife and cutting board to cut up food	1 2 3	1 2 3
Test a dish to see if it is microwave safe	1 2 3	1 2 3
Set the table for a family meal	1 2 3	1 2 3
Accurately measure liquid and dry ingredients	1 2 3	1 2 3
Follow a recipe	1 2 3	1 2 3
Break an egg	1 2 3	1 2 3
Prepare a pan for baking	1 2 3	1 2 3
Mix foods	1 2 3	1 2 3
Use the microwave to melt fat and other ingredients	1 2 3	1 2 3
Hard cook eggs	1 2 3	1 2 3
Cream butter and sugar	1 2 3	1 2 3
Beat a mixture until smooth	1 2 3	1 2 3
Cut fat into flour	1 2 3	1 2 3
Drain liquids from solid ingredients	1 2 3	1 2 3
Safely remove a pan from the oven	1 2 3	1 2 3
Test cookies, cakes and muffins for doneness	1 2 3	1 2 3
Rate baked foods for quality	1 2 3	1 2 3
Brown ground meat for sauces and sandwiches	1 2 3	1 2 3
Pour off extra fat from cooked ground meat	1 2 3	1 2 3

EXPLORE MyPLATE



When learning to prepare food, it is just as important to learn about nutrition. There are so many foods to choose from, but some of them are better choices than others. How do we know which foods to choose and how much to eat to have a healthy, balanced diet? **MyPlate** helps guide your choices. **MyPlate** shows how to balance the five food groups that are the building blocks for a healthy diet.

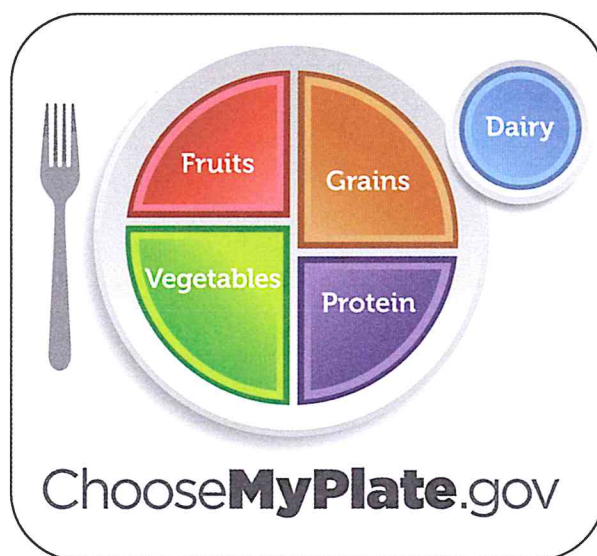

Tips to a Great Plate

1. **Make half your plate veggies and fruits.** Vegetables and fruits are full of nutrients that promote good health. Although most of us don't eat enough vegetables, we should eat a variety of vegetables every day.

Vegetables provide several different vitamins and minerals your body needs. For example, Vitamin A is found in dark green vegetables (like broccoli and spinach) and dark yellow and orange vegetables (like carrots and sweet potatoes). Vitamin A keeps the cells in our body healthy.

Fruits also provide vitamins and minerals. For example, oranges, grapefruit, strawberries, and melons have Vitamin C which helps our bodies to heal. Deep yellow fruit like apricots and cantaloupe have Vitamin A.

2. **Add lean protein.** Food from the protein group should be lean — that means it doesn't have much fat in it. Choose protein foods, such as lean beef or pork, or chicken, turkey, beans, or fish. Baking, broiling, and grilling are better choices for cooking protein foods than frying because they do not add fat to the meat.

3. **Include whole grains.** Grains are used to make bread, cereal, rice, and pasta. These foods are made from wheat, rye, oats, and rice. Try to make at least half of your grains whole grains. Whole grains are higher in fiber than others. Look for the words “100% whole grain” or “100% whole wheat” on the ingredients label. Foods from the grains group have carbohydrates. Carbohydrates provide energy for our bodies.
4. **Don't forget the dairy.** Drink a cup of fat-free or low-fat milk at each meal or with a snack. Milk gives us calcium to keep our bones and teeth strong. Milk and foods made from milk are the best sources of calcium. While we are growing, our bones need the calcium from these foods so enjoy three dairy servings every day. If you don't like milk, include fat-free or low-fat yogurt or reduced-fat cheese in your meals or snacks.

5. **Drink water instead of sugary drinks.** Cut calories by drinking water or un-sweetened beverages. Soft drinks, energy drinks, and sports drinks add extra sugar and calories to your diet that your body usually doesn't need. The extra calories are stored in the body as fat.

??????????

Did You Know

There are about 10 teaspoons of sugar in a 12-ounce can of soft drink. If you drink two of those a day, that adds 20 teaspoons of sugar – over 300 “empty calories.”

6. **Balance the food you eat with daily exercise.** Young people should get 60 or more minutes of physical activity every day. Daily physical activity helps keep your body healthy. Pick activities that you enjoy and you will find it easy and fun to reach this goal. Invite a friend or family members to join you – and don't forget the family pet. Pets enjoy exercise too.

7. **Eat these foods less often.** Cut back on foods high in fat, added sugar, and salt. This includes cake, cookies, ice cream, candy, sweetened drinks, pizza, and fatty meats like sausage, bacon, and hot dogs. Eat these foods as occasional treats, not every day foods.

??????????

Did You Know

*Foods that are high in fat and added sugar contain **empty calories** — calories that provide few or no nutrients to your body. The extra calories are stored in the body as fat.*



1

What's on Your Plate? Activity

How are you doing following the guidelines for healthy eating? Let's find out.

- Write down everything you eat for one day, including all three meals and snacks.
- On three paper or foam plates, draw the outline of the **MyPlate** graphic as shown here.

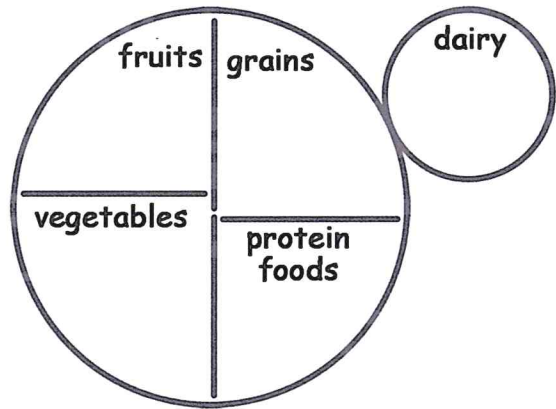

- For each meal, draw, paste pictures, or write in the foods you ate in the matching food group on one plate. For example, if you had cereal for breakfast, record that in the grains section of one plate. Add the other foods that you ate for breakfast in the matching food group.
- If you need help deciding which food group a food belongs to, visit the **MyPlate** website at MyPlate.gov and click on the **MyPlate** button at the top left of the screen. Then click on each food group for more information.
- On smaller plates, draw, paste pictures, or write in the dairy foods and snacks you ate.
- Answer these questions and decide if your meals are balanced for a healthy diet.

1. Was half of your plate vegetables and fruits for each meal? _____ If not, list some vegetables or fruits that you can add to each meal to make it balanced.

2. Did you have lean protein at each meal or snack? _____ If not, what lean protein could you add or substitute for the protein that you ate?

3. What whole grains did you eat for meals or snacks? _____

4. Did you have three servings of milk or dairy foods? _____
Were they fat-free or low-fat? _____
If not, what lower fat dairy product could you substitute? _____

5. Did you have any sugar sweetened beverages, such as a soft drink or sports drink? _____
What would be some healthier choices to replace the sweetened beverages?

6. Based on what you learned about healthy eating, how are you doing eating healthy, balanced meals and snacks?

- Not so good
- Better than I thought
- Good, but I still have room for improvement
- I made good food choices

7. What are two changes you will make to eat a balanced, healthy diet?

Learn More

To learn more about **MyPlate** and making healthy food choices,
go to ***ChooseMyPlate.gov***



1

What's in That Bottle?

What is your favorite soft drink? Store shelves are lined with soft drinks in every size, color, taste, and brand that consumers demand. But, do you know what you are drinking when you sip your favorite soft drink? Soft drinks are made from simple ingredients: carbonated water, sugar or other sweetener, and different flavorings and colorings. Most people agree that water is good for you, but not when mixed with high amounts of sugar. How much sugar? Look at the chart to find out.

Each teaspoon of sugar contains 15 calories and since sugar does not provide any nutrients, those are empty calories. Let's see how the numbers add up.

Sugar in Soft Drinks

Soft Drink Size	Servings	Grams Sugar	Teaspoons Sugar	Empty Calories
1 cup = 8 oz	1	28	7	105
12 oz = 1 can	1.5	42	10.5	157.5
16 oz = 1 bottle	2	56	14	210
20 oz = 1 bottle	2.5	70	17.5	262.5
24 oz = 2 cans	3	84	21	315
32 oz = 1 liter	4	112	28	420
44 oz = supersize	5.5	154	38.5	577.5

Adding It Up

- On the chart above, circle the two sizes of soft drinks that you usually drink.
- Gather the supplies you need: empty beverage containers for the two sizes you circled — rinsed and dried, measuring spoons, sugar, and a clean sheet of paper. If using a 12 oz. can, you'll also need a clear glass or cup.
- Roll the paper into a tube and slide one end into the bottle. Gently open the top of the roll to create a funnel. For cans, use a clear glass or cup.
- Measure the number of teaspoons of sugar listed for one size you chose and pour each teaspoon of sugar into the funnel. Repeat for second soft drink.
- Are you surprised at how much sugar is in your soft drink? Answer these questions.

1. If you drink these two soft drinks, how much sugar are you drinking?

How many empty calories does that total? _____

2. What did you learn from this activity? _____

3. What changes will you make as a result of this activity? _____



FOOD SAFETY BASICS

Cleanliness is important when preparing food to eat. Food can carry germs that make you sick. Dirty cooking utensils, hands, clothes, or work areas can also spread germs to the food you are preparing. Follow some simple rules when you are cooking to keep your food safe. These rules should become a habit — things you do without thinking because you know the rules well.

Before You Begin To Cook

- Wash your hands with soap and warm water for at least 20 seconds.
- Be sure your fingernails are clean.
- Check to see that your work area is clean.
- Wear clean clothes.
- Wear an apron or tie a clean kitchen towel around you to keep from spreading any germs to the food and to keep your clothes clean.
- Use clean cooking utensils.
- Clip long hair back so that it will not fall into the food.
- Use a clean cloth or paper towel to wipe your hands. This prevents spreading germs. Do not wipe hands on your clothes or apron.
- Use a paper towel or mop to wipe up spills on the floor. Don't use the dish cloth or towel. The floor surface is covered with germs.

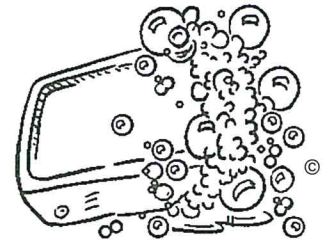

While You Are Cooking

- Keep your hands away from your hair, face, and pets. Don't lick your fingers.
- Cover your nose and mouth if you have to sneeze or cough. Wash your hands before you start to cook again.
- Do not use your mixing spoon for tasting foods. Use a separate spoon for tasting. Never put a used tasting spoon into food that is to be served to others.
- Keep dairy products, meat, poultry, and eggs cold. Don't leave them out of the refrigerator while you are cooking or they may spoil.



1

Clean the Food

- Wash fresh fruits and vegetables in plenty of cool water before using them.
- Use a vegetable brush to wash foods such as carrots, celery, and potatoes to remove any soil that remains.
- Wipe the tops of all cans, boxes, and bottles before opening them. This helps remove any germs that are on them.
- Look for clues that food is spoiled. Spoiled food can make you sick. Check the color: does it look right? Check the odor: does it smell the way it should? Check the appearance: do you notice anything unusual about the way it looks? If any of these clues make you think the food is spoiled, ask an experienced cook if the food is safe to use. Never taste food you think is spoiled.

Time for Clean up

Soaking cooking utensils will make them easier to wash. Wipe greasy dishes and pans with a paper towel before washing.

Dishwashing is easy if you use plenty of hot water and soap. (If you have an automatic dishwasher, ask how to use it.) There are three steps in washing dishes.

Step 1: Scrape and stack. Use a scraper or paper towel to remove food. Sort the dishes; put glassware together, silverware together, pots and pans together.

Step 2: Use hot, sudsy dishwater. Wash the glasses first; wash the rims carefully to destroy any germs. Then wash the silverware. Always wash sharp knives separately. Next, wash the rest of the dishes. Rinse the inside and outside of everything you wash with hot water and then let them air dry. Wash pots and pans last.

Step 3: Return any leftover ingredients and cooking utensils to storage. Clean your work area, stove top, and sink. If food has been spilled in the oven, let the oven cool before cleaning it.



KITCHEN SAFETY BASICS

Be Considerate When You Use the Kitchen

- Ask permission to use the kitchen and prepare the food.
- Keep the kitchen neat and clean while you work.
- Wash all dishes and cooking utensils and put them away when you are finished.
- Clean your work area and put away any unused ingredients and utensils.

Be Safe When Using Electrical Equipment

- Check to see that the appliance switch is in the **off** position.
- Attach electric cord to appliance if it is not already attached.
- Plug the cord into outlet.
- Turn off the motor or heat when you are finished using the equipment.
- Pull the plug from outlet **before** detaching the cord from the appliance. Do not pull on the cord because this may break the wires.
- Unplug appliances when not in use.
- Keep your fingers away from the moving blades of a blender, mixer, or food processor.
- Place the lid on the blender or food processor before turning it on.
- Unplug the mixer when putting in beaters or removing them.
- Never touch the heating element of an appliance such as a toaster. Never put a knife or other utensil into a toaster because you may get shocked. If something is stuck, unplug the toaster before trying to remove anything.
- Never plug in or unplug appliances with wet hands because you may get shocked.

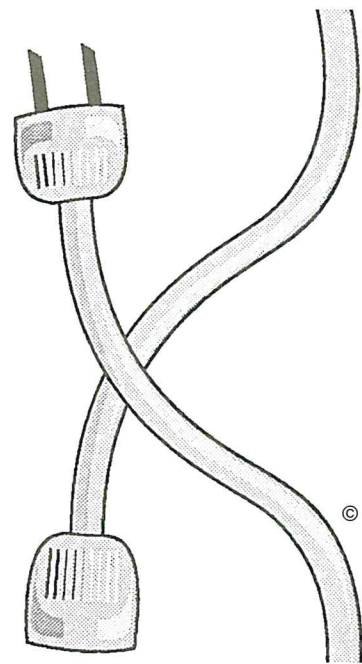

1

Be Safe When Using Microwaves

- Do not start the microwave oven when it's empty.
- Use microwave-safe dishes. It is not safe to use metal in a microwave.
- Be careful of steam when you take off a cover or open a bag that contains hot food.
- Always use potholders to take things out of the microwave. The food container can get hot from the heat or steam in the food.
- Read and follow the microwave heating directions on food packages.

To Prevent Burns

- Use hot pads or a mitt when handling hot dishes and pans. Dish towels may touch the flame or heating element and quickly catch on fire.
- Avoid using metal utensils when cooking food on top of the stove since metal becomes hot quickly. Wood and plastic utensils don't get hot as quickly.
- Use a fork, turner, spoon, or tongs to lift foods that are hot.
- Do not turn on stove burners until you are ready to use them and turn off the burners as soon as you are finished using them. Double-check to see that all the burners are turned off when you are finished cooking.
- Place the pan on the burner so that the pan handle is toward the center or the rear of the stove. This prevents someone from hitting the handle and spilling the food.
- Don't fill cooking pot over two-thirds full. This will help prevent foods from boiling over or spilling.
- Remove covers from hot foods by tilting the lid away from you. The hot steam will rise away from your face.

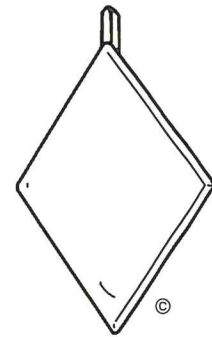
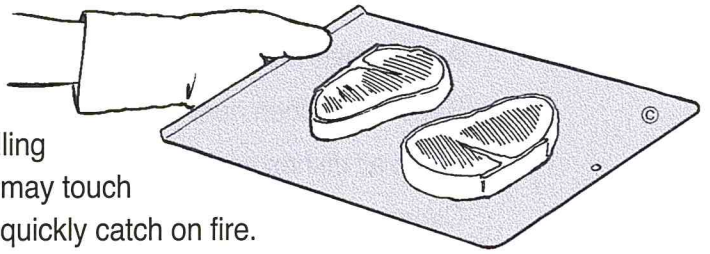

To Prevent Cuts

- If a knife starts to fall, jump back. Don't try to catch the knife.
- Keep knives sharp. Because you have to use force to cut with a dull knife, it can be more dangerous than a sharp one.
- Use a cutting board to avoid cutting yourself or cutting the table or counter top.

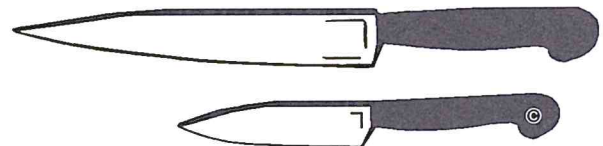

- Wash knives and put them away as soon as you are finished using them. Don't place knives in dishwater because you may cut your hand trying to find the knives.
- Use knives for cutting only. Do not use them as can openers, screwdrivers, or chisels.
- Move vegetable peelers away from you as you peel. Keep your fingers underneath the food.
- Hold food graters with one hand and the food to be grated in the other hand. Stop grating or grate slowly when only a small piece of food remains.

To Prevent Falls

- Immediately wipe up spills.
- Keep kitchen floor free from clutter.
- Use a step stool if you must reach for a high object. If you don't have a step stool, ask someone who is taller than you to get the object for you.

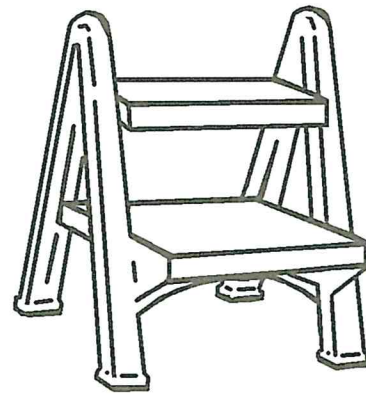

DEMONSTRATE YOUR KNOWLEDGE ON KITCHEN SAFETY BASICS



Now that you know how to keep yourself safe in the kitchen, it is time to show others what you know and can do. Ask your project helper, 4-H leader or other adult to watch as you demonstrate how to prepare your favorite cold sandwich for yourself and the adult. Explain what you are doing and why it is important to food or kitchen safety as you go through each step.

Be sure to:

- Show how to get yourself and the kitchen ready to prepare food.
- Gather all the supplies, utensils, and serving dishes you need for the sandwiches.
- Prepare the sandwiches and explain to the adult who is observing what you are doing and why it is important for food or kitchen safety.
- Clean up the work area.
- Serve the sandwiches.
- Wash the utensils and dishes. Follow the steps for washing dishes.

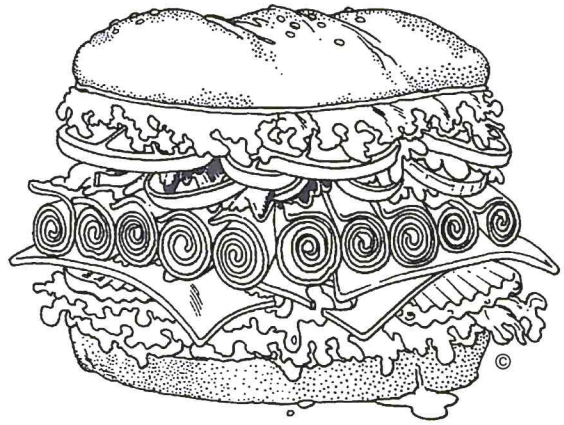

When you are finished, share with the adult your answers to these questions.

- What did you learn about food or kitchen safety?
- Why is it important to know how to handle food safely?
- What are some things you have done in the kitchen that may have been unsafe?
- How can you use what you learned about food and kitchen safety as you begin preparing your 4-H foods project recipes?

Congratulations! After demonstrating that you know how to keep food and yourself safe in the kitchen, you will be ready to begin preparing the recipes in this book.

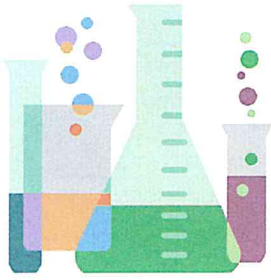

EXPERIMENT! TESTING FOR MICROWAVE-SAFE DISHES

Preparing food is actually a form of science. You must follow directions and do each step in the proper order to have good tasting food to share with others. That is much like a science experiment. In this 4-H foods project, you will learn about food science as well as how to prepare foods. Try this experiment about microwaving to get you started.

With a helper, test a non-metal dish to see if it is microwave-safe. Place the dish to be tested in the microwave oven. Measure 1/2 cup water into a 1-cup glass measuring cup. Place the filled measuring cup beside the dish to be tested. Microwave for one minute on high (100% power).

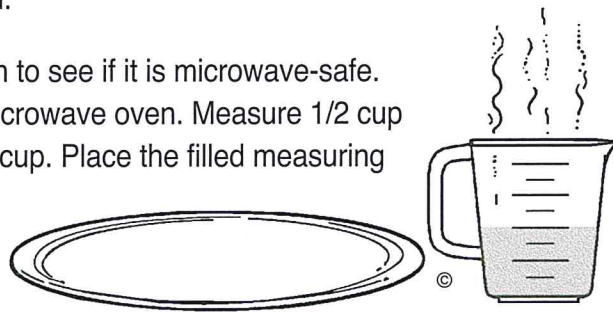

Now touch the dish and the water. Be careful when checking the dish — it may be hot! The water will be hot, but if the dish is cool, the dish is safe to use for microwave cooking. If the dish is hot, do not use it for microwave cooking. Record the answers to your experiment below.

Dish tested: _____

Is the dish safe for using in the microwave? _____

How do you know if it is safe to use or not? _____

What are some other dishes you frequently use in the microwave?

Test some of them and record the dishes that are not safe to use:



MEAL TIME BASICS



Today's families are busy and it's hard to find time for a meal together. Shared meals can help families grow closer as they talk about their day and plan for family events. Try these tips to help your family find time to share a meal and have fun too.

- **Show that family meals are important.** Turn off the television and don't answer the phone while you are eating.
- **Eat around a table.** It is easier to talk and listen when you are facing each other.
- **Enjoy your time together.** Make easy conversation — don't nag, complain or argue with your family. Have a “no bickering” rule. Any violators might have to wash dishes! Allow everyone a turn to talk. Try these conversation starters:
 - Ask everyone to share their favorite part of the day.
 - Plan the next day's dinner together.
 - Share a favorite vacation memory.
 - Discuss an activity the family can do together.
 - Talk about a book or a movie that everyone has seen.
 - Talk about upcoming holidays or vacations.
- **Be creative.**
 - Have a theme for your meals — such as a current event or ethnic food.
 - Play favorite music softly. If you are eating ethnic food play music from that nation or culture.
 - Every Sunday night is Pizza Night or Taco Night.
 - Family Picnic night — use a nearby park, back porch, or the living room!
 - “Try it” — try a new food, especially vegetables or fruits. Everyone needs to taste.
 - If the family misses an evening meal, gather for dessert or bedtime snack.
 - Have breakfast for dinner and serve your favorite breakfast food.
 - Make table decorations or centerpieces, these may be edible food.
- **Make meal preparation simple and quick.** Simple meals can taste good. Your family may bring home prepared food from a restaurant. Use disposable plates and silverware instead of washing dishes. This allows more time together as a family.

- **Get everyone involved** in preparing meals. Young children can wash vegetables, tear lettuce, and set the table. Prepare a simple dish from your 4-H project books as a meal for the family.
- **Write on the calendar** meals the family will eat together. Try weekend breakfasts too.

Setting a Pretty Table

It only takes a few minutes to set the table for your family and that extra step can set the mood for the family meal together. Sitting down to a nice table setting tells family members that they are worth the extra work. It also helps them to relax and enjoy the food that you have prepared for them. The drawing shows how to set the table for meals. Just remember to use only the silverware and dishes you need for the food you are serving — no need to wash extra dishes!

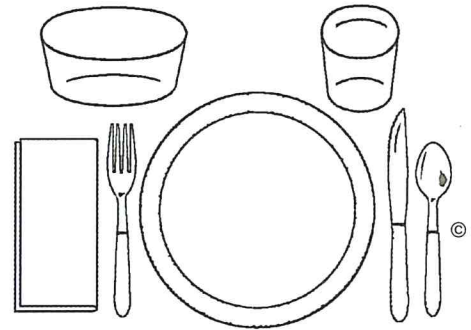

Mealtime Manners

Most of us enjoy meals served and eaten in a pleasant way. Using good manners allows other people to enjoy our company. Test your manners know-how by taking the true/false quiz below. Check your answers at the bottom of the page.

1. When you're served something you don't like, it is okay to say, "No, thank you."
2. It's okay to rest your elbows on the table.
3. Make lots of noise when you eat to let the cook know you liked the food.
4. Always wash your hands before coming to the table.
5. Tuck the napkin into your shirt collar if you are eating really messy food.
6. Don't start eating until everyone has been served.
7. If someone asks you a question while you are chewing food, answer them quickly.
8. You can blow your nose at the table, just use your napkin.
9. If you need something, just reach across the table and get it.
10. Tell everyone how you feel if you don't like the food.

Answers: 1) True; 2) False (keep your elbows off the table); 3) False (it is proper to eat quietly); 4) True; 5) False (always place the napkin on your lap); 6) True; 7) False (wait until you chew and swallow the food); 8) False (excuse yourself from the table); 9) False (ask others to pass it, please); 10) False (when you don't like a food, simply pass it up or say no thank you)



MEASURING BASICS



A recipe is like a scientific formula. You have to follow it carefully to get a product that looks and tastes good. Measuring is so important to successful baking that special equipment is used to measure ingredients. Standard measuring cups and spoons make measuring easy and accurate.

- **Dry measuring cups** are used to measure dry ingredients and solid fats. These cups are marked 1 cup, 3/4 cup, 2/3 cup, 1/2 cup, 1/3 cup, and 1/4 cup and have a flat, level rim.
- **Liquid measuring cups** are used to measure liquids such as milk, juice, water, or oil. These cups have a spout and measurement markings.
- **Measuring spoons** come in sets of 1 tablespoon, 1 teaspoon, 1/2 teaspoon, and 1/4 teaspoon.

Because accurate measuring is so important to cooking and baking, there are some basic measurements that every good cook should know. You might want to create a rap or song to help you remember these equivalents — measurements that are the same amounts.

Dry Ingredient Equivalents

1 tablespoon	3 teaspoons
1/8 cup	2 tablespoons
1/4 cup	4 tablespoons
1/3 cup	5 tablespoons + 1 teaspoon
1/2 cup	8 tablespoons
2/3 cup	10 tablespoons + 2 teaspoons
3/4 cup	12 tablespoons
1 cup	16 tablespoons

Liquid Ingredient Equivalents

2 tablespoons	1 fluid ounce	1/8 cup
1 cup	8 fluid ounces	1/2 pint
2 cups	16 fluid ounces	1 pint
4 cups	32 fluid ounces	1 quart
8 cups	64 fluid ounces	1/2 gallon

1

How to Measure Liquids

1. Place the measuring cup on a level surface while you are pouring the liquid into it.
2. To get an accurate measurement, bend down and read the measure at eye level.

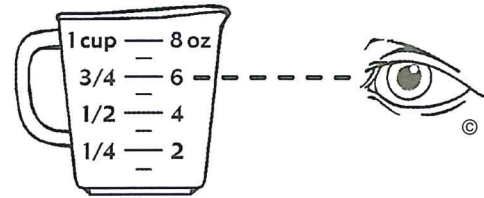

How to Measure Solid Fats

Butter, margarine, lard, and shortenings are solid fats used in cooking and baking. Some recipes call for meat drippings or poultry fat. Fats add flavor to food; make cakes, cookies, and breads tender; and make other foods crispy.

1. Use measuring spoons or dry measuring cups to measure solid fats.
2. Allow the fat to stand at room temperature so it is soft enough to measure easily.
3. Press the fat into the measuring cup with a spoon or spatula to remove air spaces. Overfill the measuring cup with fat.
4. Level off the fat with the straight edge of a knife.
5. Use a scraper to remove all the fat from the measuring cup.

Fats, such as margarine or butter, are packaged in 1/4 pound sticks to help with measuring. One stick (1/4 pound) of fat equals 1/2 cup or 8 tablespoons. The tablespoon measurements are marked on the wrapper.

How to Measure Flour

To measure flour, spoon flour lightly into the measuring cup until it is overfull. Do not shake or tap the cup because this causes the flour to pack. Too much flour may cause the food you are preparing to be dry or tough. Level the flour with the straight-edge of a knife. Measure flour over a piece of clean waxed paper or an empty plate so you can return the unused flour to the storage container. Unless a recipe calls for sifted flour, it is not necessary to sift the flour before measuring.

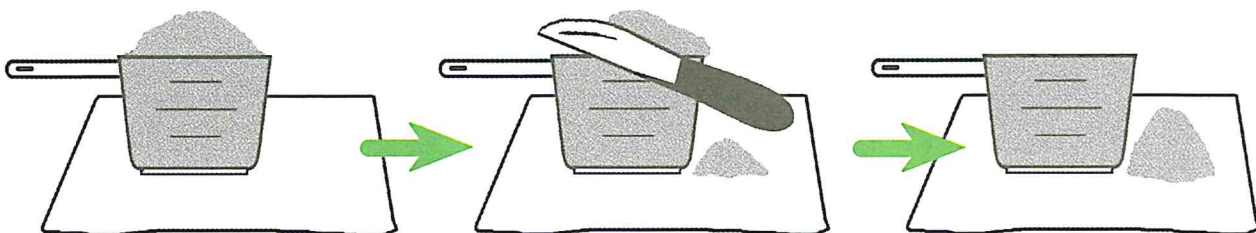

When a recipe calls for **sifted flour**, sift the flour before you measure it, even flour that is labeled pre-sifted. If you do not have a sifter, measure the flour then remove 2 level tablespoons of flour from the cup.

Types of Flour:

All-purpose flour — White flour used in a variety of foods.

Cake flour — Fine, soft, satiny flour used to make cakes. One cup minus 2 tablespoons all-purpose flour can be substituted for 1 cup cake flour.

Self-rising flour — Flour has leavening and salt added to it. If you use this kind of flour, use recipes developed especially for it. One cup all-purpose flour plus 1 1/2 teaspoons baking powder and 1/2 teaspoon salt can be substituted for 1 cup self-rising flour.

Unbleached flour — Flour is the same as all-purpose flour, but it has not been bleached and may not look as white as bleached all-purpose flour.

Whole-wheat flour — Flour is brown in color and is made from the complete wheat kernel (including the bran and germ). It gives a nutty flavor and a heavier texture than all-purpose flour.

How to Measure Sugar

Granulated white sugar — Break up any lumps in the sugar. Scoop sugar into measuring cup or spoon. Level off excess with the straight edge of a knife.

Brown sugar, light or dark — Fill the measuring cup or spoon with brown sugar. Pack it down with a spoon or your clean fingers until measure is overfull. Level off excess. When brown sugar is removed from the cup, the sugar will keep the shape of the cup.

Powdered (confectioners) sugar — Unless the recipe says to sift before measuring, measure powdered sugar the way you do granulated white sugar.

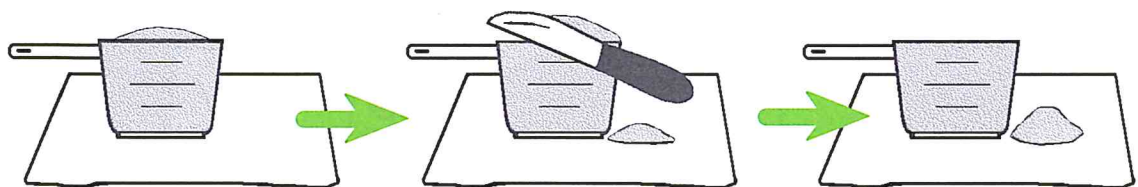

How to Measure Other Ingredients

Baking powder and baking soda — These products must be measured very carefully because too much or too little baking powder or baking soda can affect the way baked foods look, feel, and taste. Before measuring use a spoon to break up any lumps. Dip dry measuring spoon into container. Take out a heaping measure. Level off excess.



Biscuit mixes — Do not sift before measuring. Spoon the mix lightly into measuring cup. Level off excess.

Cocoa powder and chocolate squares — Stir cocoa to break up any lumps. Dip measuring spoon into cocoa. Take out a heaping measure. Level off excess. Chocolate is marked or packed in 1-ounce squares. Recipes always state chocolate in ounces. You can substitute 3 tablespoons of cocoa for 1 ounce of chocolate. Chocolate contains more fat than cocoa, so when you use cocoa in place of chocolate the product will taste less rich.

Dry milk — Pour dry milk powder into measuring container until it is overfull. Level off excess.

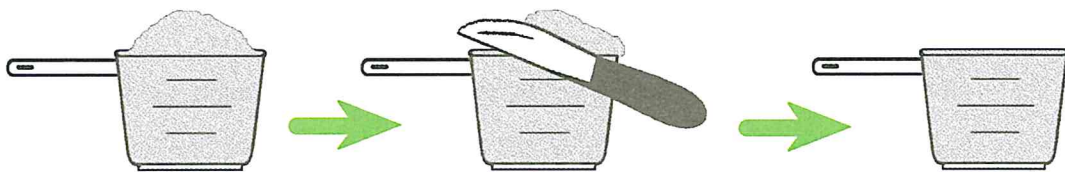

Salt and spices — Dip dry measuring spoon into the container if the opening is large enough. Take out a heaping measure. Level off excess. If the spoon will not go into the container, shake the salt or spice into the spoon. Hold spoon over clean waxed paper so that any you spill can be returned to the container. Level off excess.

Vanilla and liquid flavorings — Hold measuring spoon over a small cup, not the mixing bowl. Pour flavoring into spoon.

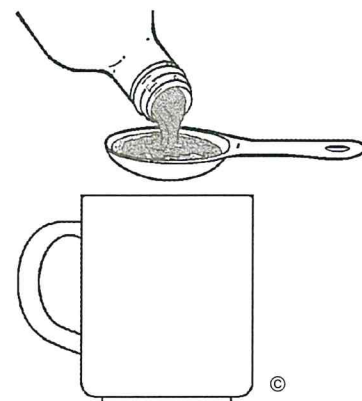

EXPERIMENT!

HOW MUCH FLOUR WILL A MEASURING CUP HOLD?

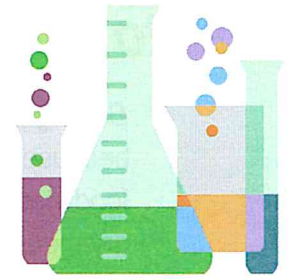

Supplies

- Flour in a bag or canister
- Waxed paper
- Dry measuring cups
- Measuring spoons
- Spatula
- Spoon
- Sifter

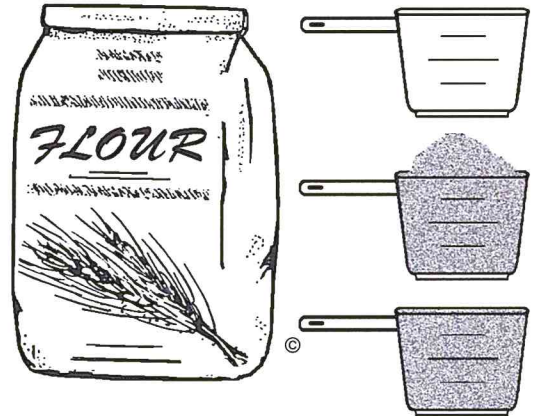

Procedure and Observations

Part A

1. Dip measuring cup into flour, filling the cup to overflowing. Level off excess flour.
2. Sift the cup of flour you have just measured onto waxed paper. Gently spoon the sifted flour back into the measuring cup. Level off excess flour.
3. Did you get all the flour back into the cup? _____
4. If you had flour left over, use the measuring spoons to determine how much.
5. Record the amount that was left over: _____ tablespoons and _____ teaspoons.

Part B

1. Measure another level cupful of flour from the bag or canister, but this time spoon the flour gently into the cup instead of dipping. Level off the excess flour.
2. Sift flour onto waxed paper. Gently spoon the sifted flour back into the measuring cup. Level off excess flour.
3. Did you get all of the flour back into the cup? _____
4. If you had flour left over, use the measuring spoons to determine how much.
5. Record the amount that was left over: _____ tablespoons and _____ teaspoons.

Part C

1. Using the cup of sifted, measured flour, tap the cup on the table four to five times. Be careful to not spill any.
2. Is the cup still full? _____
3. If not, add enough flour to fill the cup again by adding a level teaspoon until the cup is full. Record how many teaspoons you added: _____ teaspoons

Part D

1. Did the three methods of measuring flour affect how much flour was left over? If so, how?

2. Based on the results of your experiment, which method of measuring flour would you use when preparing a recipe? Why?

3. How do you think the extra flour might affect the food you are preparing?

4. What would you tell a beginning cook about measuring ingredients for a recipe?



COOKING "How To" BASICS



How to Follow a Recipe

1. Read the entire recipe first.
2. Wash and dry your hands.
3. Gather the ingredients for the recipe to be sure you have everything you need.
4. Gather the equipment you will need.
5. If needed, turn on the oven and set the temperature.
6. Prepare the pan, dish, or cookie sheet.
7. Follow the recipe step by step to measure, mix, and prepare the food.

How to Break an Egg

Hold the egg in one hand. Use the edge of a knife to lightly hit the egg and break the shell. Hold the egg over a small bowl and pull the shell apart. The egg will slide into the bowl. Check to see that the egg is good before you add it to your mixture. If the recipe calls for more than one egg, repeat this procedure.

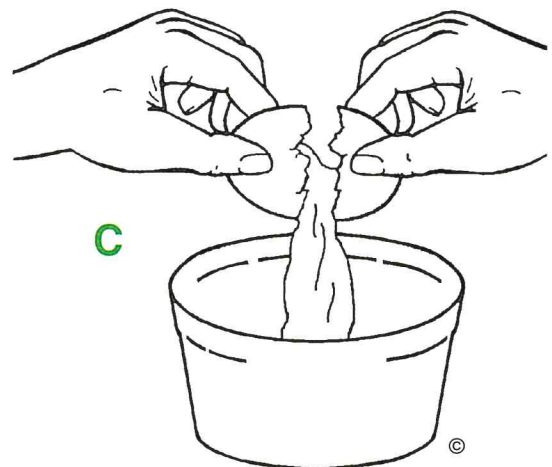
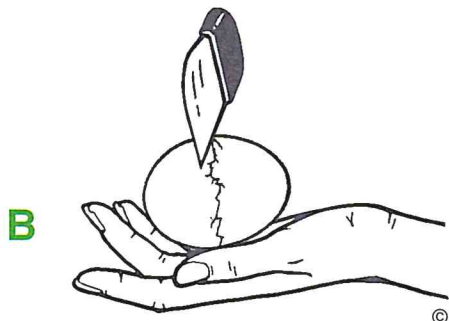
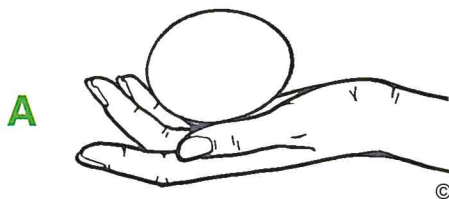

How to Melt Fat

When a recipe calls for melted fat, such as margarine, butter or lard, measure it after melting. Using the microwave makes melting fat easy. Place the fat in a microwave safe bowl and cover with a paper towel or plate. Cooking time will vary depending on the amount of fat to be melted. Start with a few seconds and add more cooking time if necessary. Equal amounts of cooking oil can be substituted for melted fat.

How to Prepare a Pan

Lightly coat the pan with a small amount of cooking spray. Or use a paper towel or a piece of waxed paper to spread a small amount of cooking oil or fat over the bottom and sides of the pan. Do not coat the sides of the pan when baking a cake because cake batters need to cling to the sides of the pan while baking.

How to Flour a Pan

First, lightly coat the pan with non-stick cooking spray or shortening. Then place about 1 tablespoon of flour in the pan. Shake the pan until it is coated with the flour. Any flour that does not stick should be discarded. Recipes often call for flouring a pan when baking cakes or quick bread.

How to Use an Electric Mixer

Ask someone to show you how to use the electric mixer and how to insert and remove the beaters. Follow these safety rules when using an electric mixer.

- Lower the beaters into the food before turning on the motor.
- Turn off the motor when using a spatula or spoon to scrape down the sides of the mixing bowl.
- Turn off the motor before lifting the beaters from the food.
- Keep finger and utensils away from beaters when mixer is on.

How to Use the Oven

Some recipes tell you to preheat the oven. Turn on the oven as you begin preparing the recipe so it is at the correct temperature when the food is placed in the oven. Before you turn on the oven, position oven racks in the center of the oven. Food placed on lower or upper racks will cook unevenly. Leave enough space between



oven racks to allow baked foods to rise. Turn the thermostat to the temperature stated in the recipe. When oven is heated, place the food to be baked in the center of the oven. Once food is in the oven, open the door only when necessary to avoid losing heat. Test the food for doneness a few minutes before the end of the baking time because oven temperatures vary. Use a dry potholder or oven mitt to slide the rack forward and remove the food from the oven. Never reach into the hot oven because you may touch a hot surface and burn your hand or arm. Turn off the oven when you have finished baking. When the oven is cool, clean up any food that may have spilled in the oven.

How to Use a Cutting Board and Knife

Many fruits and vegetables need to be trimmed or peeled before using. To trim or cut the food, hold food firmly on the cutting board with one hand. Keep your fingers curled back away from the knife blade while you cut. When cutting round foods such as onions or apples, you first need to create a flat surface. Start by cutting down the middle of the food and place the flat side on the board before chopping. Cut each half into four or five slices. Hold the slices together and cut across them in the size pieces you need. To avoid spreading germs: wash, rinse, and sanitize the cutting board after each use — especially when cutting meat, poultry, or seafood. To sanitize the cutting board, dilute one tablespoon of bleach in a gallon of water and use as the final rinse.

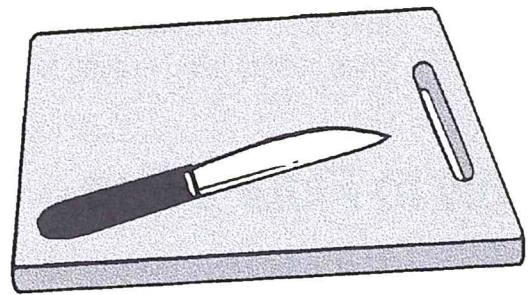

How to Mix Foods

Recipes will use some basic terms you need to know to mix the food. Using the correct methods to mix the foods gives you better results. If you don't understand, ask someone to show you the following ways to stir food.

- **Beat** — makes a mixture smooth and fluffy by quickly lifting mixture over and over using a spoon, fork, whisk, or electric mixer.
- **Cream** — gives the mixture a smooth, creamy texture. Mix ingredients together using a mixer or spoon until the mixture is soft and creamy. Butter and sugar are creamed together for cakes and cookies. If using butter, margarine, other solid fats, or cream cheese, allow the fat or cream cheese to stand at room temperature until it is soft before creaming.
- **Stir** — mix food round and round using a mixing spoon or fork.

DEMONSTRATE YOUR KNOWLEDGE ON COOKING “HOW TO” BASICS



Each year you are enrolled in the *4-H Cooking 101* project, select 3 to 5 of the Cooking “How To” Basics to demonstrate to your project helper, leader or club. Share what you have learned about each topic. Use the following demonstration guide to plan your demonstrations.

Following are some tips on giving a good foods project demonstration:

- A good demonstration is one of the best ways to teach someone how to do something. It links your words to action.
- Limit your demonstration to one main idea, for example, how to correctly measure dry ingredients for a recipe.
- Check your fingernails to make sure they are clean.
- Put on an apron, pull your hair back if necessary, and wash your hands before beginning your demonstration.
- Gather all the equipment and supplies you will need before the demonstration begins.
- Arrange your equipment or supplies in the order you will use them.
- Use your own words to describe what you are doing in each step of the demonstration.
- Show each step in the order it is to be done.
- Keep equipment and supplies away from the front of your working space so your project helper can see your work.
- If you have them, use clear mixing bowls, measuring cups, etc, so your project helper can see what you are doing.
- Keep a hand towel or paper towels handy to use as necessary.
- Have fun teaching others about cooking.

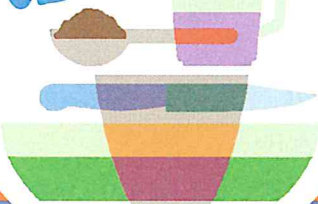

■ Make Your Own Cocoa Mix

Yield: 10-12 servings

Ingredients

- 4 cups instant non-fat dry milk
- 3/4 to 1 cup cocoa
- 3/4 to 1 cup granulated sugar

Equipment

- Measuring cup
- Measuring spoon
- Mixing spoon
- Knife to level measure
- 2 quart mixing bowl
- Food storage container with lid or a large plastic food storage bag

Order of Work

1. Measure all ingredients carefully. The amount of cocoa and sugar you use depends on your own taste. If you like a rich cocoa flavor or sweet taste, use the 1-cup measure. If you like a milder cocoa flavor or not-too-sweet taste, use the 3/4-cup measure.
2. Mix ingredients together in the food container or bag.
3. Put the lid on the container. Store at room temperature.
4. To make cocoa from mix:
 - Stir mix. Use 1/2 cup mix for each cup of water. Place mix in a microwave-safe mug. Add 1/2 cup water to mug. Stir until all lumps disappear. Then add remaining water and stir.
 - Place the mug filled with cocoa mix in the microwave. Heat on high for 60 to 90 seconds. The time will vary depending on the microwave. Be careful when removing mug from microwave as it may be very hot.



Cereal-Marshmallow Bars

Yield: 24 bars

Ingredients

- 3-4 tablespoons butter or margarine (not reduced fat)
- 40 large marshmallows or 4 cups of mini marshmallows (10 ounce package)
- 5-6 cups ready-to-eat cereal

Equipment

- Measuring cups
- Large microwave-safe mixing bowl
- Large mixing bowl
- Cooking spoon
- 9"x13" pan
- Heavy saucepan (optional)

Order of Work

1. Lightly coat the pan with non-stick cooking spray.
2. Place butter or margarine and marshmallows in large microwave-safe mixing bowl. Place in microwave on high setting for 2 minutes. Stir. Microwave an additional 1 to 2 minutes or until melted. **OR** you may melt the margarine or butter and marshmallows over low heat in a heavy saucepan while stirring continually.
3. While the marshmallows and butter or margarine are melting, measure the cereal into a large bowl.
4. Stir the melted butter or margarine and marshmallows. Pour this over the cereal. Stir gently until cereal mixture is evenly coated. You may need an adult to help you with this step.
5. Carefully press the warm marshmallow-cereal mixture in the prepared pan.
6. Cool. Cut into small squares or bars.

For extra-special cereal-marshmallow bars, add some chocolate bits, chopped dates, candied fruits, or nuts. You can use one or more of these and mix them with the cereal before adding the marshmallow mixture.

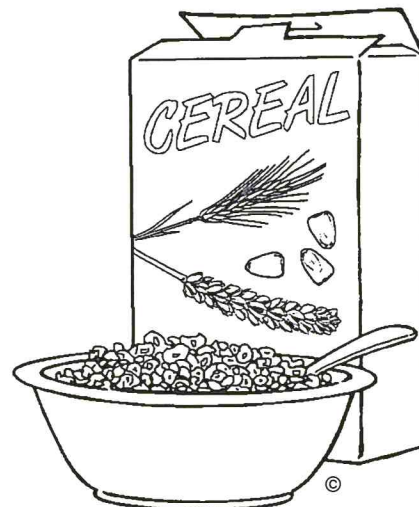

Chewy Granola Bars

Yield: 12 bars

Ingredients

2 1/2 cups rolled oats, old-fashioned or quick
 1/2 cup chopped nuts
 1 cup firmly packed brown sugar
 1/2 cup seedless raisins or dried fruit, chopped
 2 eggs
 1/3 cup butter or margarine, melted
 1 teaspoon vanilla extract

Order of Work

1. Preheat oven to 350 degrees F. Lightly coat the baking pan with non-stick cooking spray.
2. In bowl, combine oats, nuts, brown sugar, and raisins or dried fruit.
3. Stir in eggs, margarine, and vanilla. Mix until evenly combined.
4. Press mixture firmly into the prepared baking pan.
5. Bake for 25 to 30 minutes. Cool for 10 minutes. Cut into bars.

Equipment

Mixing bowl and spoon
 Measuring cups and spoons
 Baking pan, 9"x9"



Quick Veggie Pizza

Yield: 6 servings

Ingredients

3 English muffins cut in half or 6 slices Italian bread
 1/2 cup chopped vegetables (such as sliced onion,
 chopped green peppers, sliced mushrooms,
 and/or sliced olives)
 1 cup shredded cheese
 1 cup pizza or spaghetti sauce

Order of Work

1. Preheat oven to 425 degrees F.
2. Use fork to split English muffins (or use knife to slice Italian bread) and place on an ungreased cookie sheet.
3. Spread small amount of pizza sauce (2-3 tablespoons) over bread.
4. Add chopped vegetables and cheese.
5. Place cookie sheet in oven and bake for 5 to 7 minutes or until cheese melts.
6. Remove from oven using hot pad. Ask an adult to show you how to do this. Serve pizzas.

Equipment

Cookie sheet
 Fork
 Knife
 Cutting board
 Hot pads
 Spoon
 Measuring cups

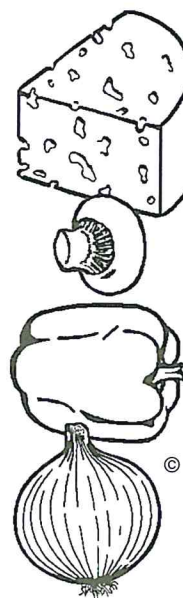

Shake It Up Pudding

Yield: 4 to 5 servings

Ingredients

1 small package (4 servings) instant pudding mix
2 cups milk*
Fruit, optional**

Equipment

Quart jar with lid
Measuring cup
Spatula

Order of Work

1. Measure milk into the jar. Add the pudding mix.
2. Put the lid on the jar tightly. Shake this mixture until pudding mix is dissolved, about two minutes. If you want to add fruit to the pudding, open the jar lid, add the fruit, replace and tighten the lid; shake again.
3. Pour pudding into four or five individual dishes. Use spatula to remove all the pudding from the jar. Refrigerate and wait 5 minutes before serving.

*You may substitute 2 cups water and 2/3 cup instant non-fat dry milk powder for milk. In step 1, measure water into the jar and add dry milk, then the pudding mix. Proceed to step 2.

**Ideas for adding fruit to pudding:

Banana: Follow the above directions using butterscotch pudding mix and one sliced banana.

Fresh berries: Follow the above directions using banana cream pudding mix and 1 cup fresh strawberries or raspberries.

Canned fruits: Follow the above directions using vanilla pudding mix. Instead of milk, use 2 cups juice drained from fruit. If there isn't enough juice, add enough milk to make 2 cups of liquid. Add drained fruit.



■ Fruit and Cheese Kabobs

Ingredients

Bananas
 Other fruit: apples, oranges, canned pineapple chunks (drained), strawberries, etc.
 Mild-flavored chunk cheese (such as Cheddar or Colby)

Order of Work

1. Wash banana and other fresh fruit with cold water.
2. Peel bananas and other fruit if needed.
3. Cut fruit and cheese into bite-size pieces.
4. Carefully push skewer through alternating pieces of fruit and cheese.
5. Place on plate or napkin to serve immediately.

Equipment

Small kitchen knife
 Cutting board
 Metal or wooden skewers
 or thin straws
 Plate or napkins

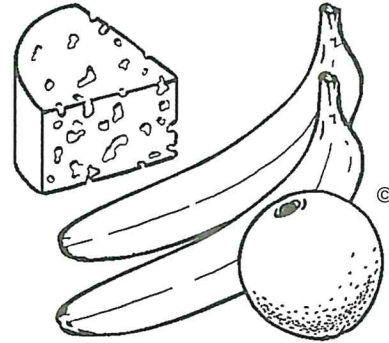

■ Fruity Shake

Yield: 2 servings

Ingredients

1 cup chilled orange juice
 1 cup milk or low-fat yogurt or frozen yogurt
 1 1/2 cups strawberries, fresh or frozen
 1 banana, peeled

Order of Work

1. Measure the orange juice, milk, and strawberries into the blender container.
2. Cover and blend just until the mixture is smooth.
3. Add the banana, cover, and blend again until smooth.
4. Pour mixture into glasses. Serve immediately.

Equipment

Blender
 Measuring cups
 Glasses

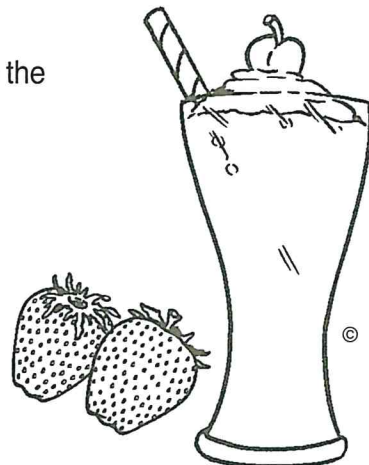

■ Mexican Layered Dip

Yield: 4 to 6 servings

Ingredients

1 can (15 oz.) refried beans
 1/4 cup taco sauce
 1 teaspoon chili powder (if desired)
 1 cup shredded, reduced-fat Monterey Jack
 or Cheddar cheese
 Shredded lettuce, chopped tomatoes, and/or
 sliced green onion as desired
 Low-fat crackers or tortilla chips

Equipment

Small bowl
 Dinner-size plate or serving plate
 Large spoon
 Knives
 Cutting board
 Measuring cups

Order of Work

1. Place the refried beans in the bowl.
2. Add the taco sauce and chili powder to the beans and mix well.
3. Spread bean mixture evenly on the plate, and sprinkle shredded cheese over the beans. If desired, microwave on high for 60 to 90 seconds to melt the cheese.
4. Sprinkle lettuce, tomatoes, and onion over cheese.
5. Serve with chips or crackers.

■ Pocket Sandwiches

Yield: 1 serving

Ingredients

1 large pita bread round (whole wheat or white)
 Mayonnaise or mustard
 2 ounces thin-sliced ham or other lean sandwich meat
 1/4 cup shredded reduced-fat cheese, any kind
 Shredded lettuce, onion slices, tomato slices, and/or
 sprouts, as you like

Equipment

Knives
 Cutting board
 Measuring cups

Order of Work

1. Cut the bread in half; open halves to make pockets.
2. Spread the inside with mayonnaise and/or mustard.
3. Fill halves with meat, cheese, and vegetables.

Zoo Snacks

Yield: 6 servings

Ingredients

- 2 tablespoons margarine or butter
- 1 cup small teddy-bear-shaped cookies
- 1 cup small animal-shaped crackers
- 1/2 cup dry roasted peanuts
- 1/2 cup raisins
- 2 tablespoons granulated sugar
- 1/2 teaspoon ground cinnamon

Order of Work

1. Put margarine in a casserole dish and cover with waxed paper.
2. Microwave on high for 15 to 20 seconds, until margarine is melted.
3. Carefully remove waxed paper and add cookies, crackers, and peanuts. Toss until well-coated.
4. Microwave on high 1 minute; stir and microwave 1 minute longer.
5. Stir in raisins.
6. Mix together sugar and cinnamon, and sprinkle over cookie mixture.

Equipment

- 2 quart microwave-safe bowl or casserole dish
- Waxed paper
- Potholders
- Table knife
- Long-handled spoon
- Measuring cups
- Measuring spoons

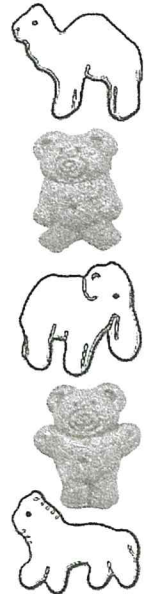

Breakfast Sundae

Yield: 1 sundae

Ingredients

- 1/2 cup vanilla yogurt (can substitute low fat, low calorie yogurt)
- 4 tablespoons canned fruit in own juice, drained, or sliced fresh fruit
- 1 tablespoon of multi-grain or granola cereal

Order of Work

1. In a 5-ounce cup, place 1/4 cup yogurt, add 2 tablespoons fruit.
2. Repeat and top with cereal.
3. Serve immediately.

Equipment

- Measuring cups
- Measuring spoons
- Serving cups



SIDE DISHES

RECIPES



■ The Best Applesauce

Yield: 3 servings

If you've never had homemade applesauce, you might be surprised at how good it is!

Ingredients

- 2 cooking apples (such as Jonathan or Rome)
- 1/3 cup water
- 1/4 teaspoon cinnamon
- 1 to 2 teaspoons granulated sugar, if desired

Equipment

- Paring knife
- Cutting board
- Saucepan with lid
- Measuring cup
- Measuring spoons
- Fork or potato masher (optional)

Order of Work

1. Wash apples; peel, core, and cut them into small chunks. Ask for help if you haven't done this before.
2. Place the apples in a saucepan and add water and cinnamon.
3. Bring to a quick boil; then cover and simmer until the apples are soft (8 to 10 minutes). Stir occasionally.
4. If desired, mash with fork or potato masher.
5. Add sugar to taste if desired. Serve warm or cold.

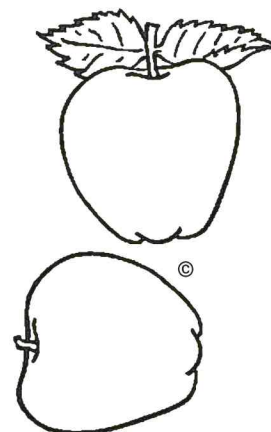

Magical Fruit Salad

Yield: 8 servings

Ingredients

- 1 can (8 oz) pineapple tidbits, packed in juice
- 1 cup seedless red or green grapes
- 2 bananas
- 1 small package (4 servings) instant vanilla pudding
- 1 3/4 cup low-fat milk

Equipment

- Can opener
- Strainer or colander
- Knife
- Mixing bowl
- Mixing spoon
- Liquid measuring cup
- Serving bowls

Order of Work

1. Drain pineapple.
2. Wash and drain grapes.
3. Peel and slice bananas.
4. Place all fruit into a large bowl and sprinkle with pudding mix.
5. Slowly add milk.
6. Stir for 2 to 3 minutes until ingredients are well mixed.
7. Let sit at least 5 minutes in refrigerator. Serve immediately. Refrigerate leftovers.

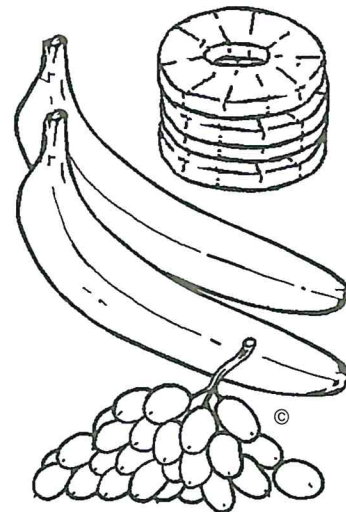

Fruity Fruit Salad

Yield: 6 servings

Ingredients

- 1 small package any fruit-flavored gelatin
- 1 cup boiling water
- 1 cup cold liquid
- 1/2 to 1 cup drained, diced, canned pineapple
- 1 tart apple, diced
- 1 banana, peeled and sliced

Equipment

- Measuring cups
- Microwave-safe bowl
- Bowl
- Colander or strainer
- Cutting board
- Sharp knife
- Large spoon
- 1 1/2 quart serving dish

Order of Work

1. Heat water in microwave 1 to 2 minutes or until boiling.
2. While water is heating, empty the gelatin package into the bowl.
3. Carefully remove water from microwave using hot pads. Add hot water to gelatin. Stir until gelatin is dissolved.
4. Add 1 cup cold liquid. This can be the juice drained from the pineapple plus enough water to make 1 cup of liquid. Have someone show you how to drain the juice off the canned pineapple.
5. Place in refrigerator and chill until slightly thickened. Rinse unpeeled apple and banana with cold water.
6. Place apple on cutting board and cut it in half and then into quarters. Remove the core from each wedge. Cut each quarter in half lengthwise. Slice wedges crosswise.
7. Peel and slice the banana.
8. Fold the banana, the diced apple, and drained pineapple into the slightly thickened gelatin.
9. Pour salad mixture into a serving dish and place in refrigerator to set.
10. Serve the salad as a dessert with or without whipped topping **OR** as a salad on crisp greens with or without salad dressing.

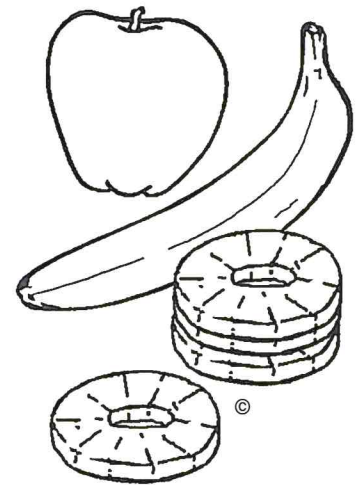

Make Your Own Salad Bar

Yield: 4 to 6 servings

Ingredients

3 cups torn or cut greens

Choose other fresh vegetables (2 cups total) to add to the salad. Here are some suggestions:

- Cucumber, sliced or diced
- Celery, sliced
- Radishes, cut in thin slices
- Carrots, sliced or chopped
- Green onions, sliced
- Ripe tomatoes, chopped
- Favorite salad dressing(s)

Equipment

Cutting board

Sharp knife

Large bowl for salad

Small serving bowls, one for each vegetable selected

2 forks or salad fork and spoon

Order of Work

1. Tear or cut greens into bite-sized pieces. Put in salad bowl.
2. Slice, chop, or dice all vegetables. Place each in a small serving bowl.
3. Refrigerate salad greens and vegetables until you are ready to serve to keep them crisp.
4. Serve salad greens, assorted vegetables, and favorite salad dressing for each person to make their own salad — just like a salad bar. Use two forks or salad fork and spoon to serve salad greens.

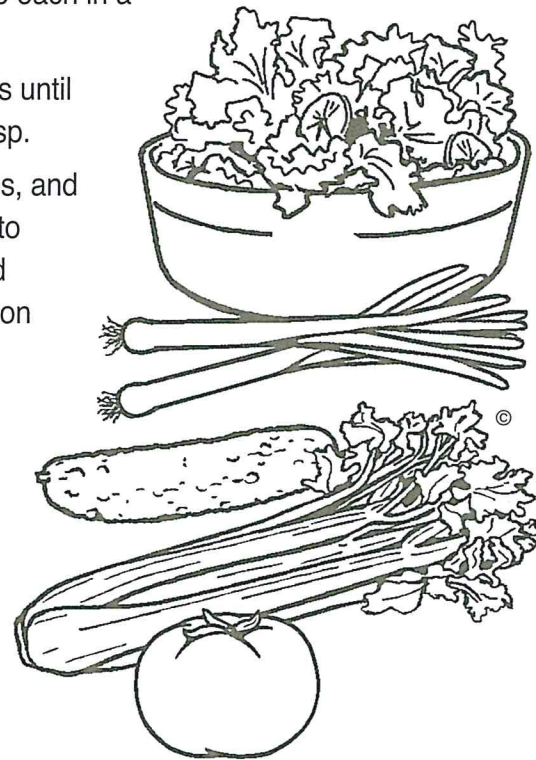

Scalloped Corn

Yield: 4 to 6 servings

Ingredients

- 1 can (16 oz.) cream-style corn (2 cups)
- 1/2 cup cracker or bread crumbs
- 1/4 cup chopped onion
- 1/4 cup chopped green pepper (optional)
- 1/2 cup milk
- 1 egg, slightly beaten
- 1/4 teaspoon salt
- 1/8 teaspoon pepper
- 1 tablespoon butter or margarine (not reduced fat)

Equipment

- Non-stick cooking spray
- Can opener
- Measuring cup
- Measuring spoons
- Sharp knife
- Cutting board
- Scraper
- Mixing bowl
- Fork
- 1 to 1-1/2 quart baking dish
- Hot pads

Order of Work

1. Preheat oven to 350 degrees F.
2. Lightly coat the baking dish with non-stick cooking spray.
3. Peel onion and chop it. Measure. (You can use 2 tablespoons of dried onion in place of the fresh onion.) Wash green pepper. Have someone show you how to remove the seeds. Chop enough green pepper for 1/4 cup.
4. Prepare the cracker or bread crumbs. It takes about 10 or 12 crackers to make 1/2 cup of crumbs. An easy way to make crumbs is to place the food in a plastic bag. Then roll with a rolling pin or can.
5. Break egg into mixing bowl. Stir with fork until yolk and white are mixed.
6. Open can of corn. Add corn to egg in the mixing bowl. Add chopped onion and pepper, milk, cracker or bread crumbs, and salt and pepper. Add green pepper if desired. Stir until mixed. Be sure to stir all the way to the bottom.
7. Pour into prepared baking dish. Dot with butter. To do this, scatter small bits of butter over the top.
8. Bake uncovered for 30 minutes.

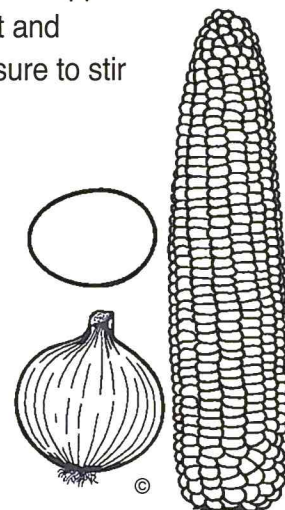

Easy-to-Fix Green Beans

Yield: 4 to 6 servings

Ingredients

- 2 cans (16 oz. each) green beans or 4 cups of frozen green beans
- 1 can (10 3/4 oz.) cream of mushroom, celery, or chicken soup
- 1/2 cup milk
- 1/2 cup crushed potato chips or canned fried onions

Equipment

- Non-stick cooking spray
- Can opener
- Colander
- Mixing bowl
- Measuring cups
- Mixing spoon
- Scraper
- 1 1/2- 2 quart baking dish
- Hot pads

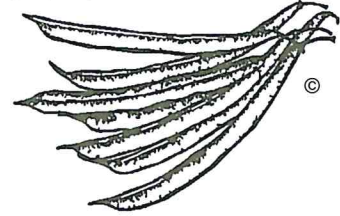

Order of Work

1. Preheat oven to 375 degrees F.
2. Lightly coat the baking dish with non-stick cooking spray.
3. Open the beans and drain off all the liquid. (If you don't know how to do this, have someone show you.)
4. Combine drained beans, soup (use a scraper to remove all the soup from the can), and milk in a mixing bowl.
5. Pour mixture into prepared baking pan.
6. Sprinkle crushed potato chips or fried onions over the top.
7. Bake uncovered until it is hot and bubbly in the center — about 20 to 30 minutes.

Carrot-Raisin Salad

Yield: 3 servings

Ingredients

- 3 carrots
- 1/2 cup raisins
- 1/4 cup mayonnaise, low-fat mayonnaise, or yogurt
- 1 teaspoon granulated sugar

Equipment

- Paring knife
- Bowl
- Vegetable peeler
- Mixing spoon
- Grater

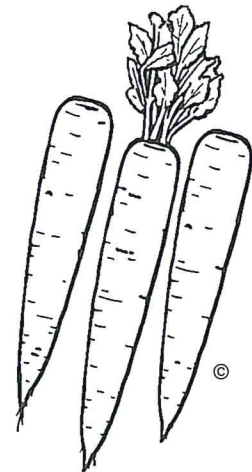

Order of Work

1. Cut off the ends of the carrots. Peel with the vegetable peeler.
2. Use the grater to shred the carrots into a bowl.
3. Add the raisins, mayonnaise, and sugar. Mix well. Chill until served.



Deviled Eggs

Yield: 12 egg halves

Ingredients

- 6 hard-cooked eggs*
- 2 teaspoons vinegar or lemon juice
- 1/2 teaspoon prepared mustard
- 1/4 teaspoon salt
- 1/8 teaspoon pepper
- 2 tablespoons mayonnaise or salad dressing

Equipment

- Knife
- Measuring spoons
- Fork
- Small bowl
- Plate
- Scraper
- Teaspoon

Order of Work

1. Cut the eggs in half lengthwise. Remove the yolks with a teaspoon. Place yolks in a bowl and egg whites on a plate.
2. Mash the yolks with a fork.
3. Add remaining ingredients to the yolks and beat until smooth. If the mixture is very stiff, add 1 or 2 more teaspoons of mayonnaise or salad dressing.
4. With a teaspoon, fill the egg whites with the yolk mixture.
5. Keep deviled eggs refrigerated until you are ready to serve them.

Deviled eggs look very pretty if you put a dash of paprika on top of the yolk stuffing. Another garnish idea is a parsley leaf on top of the stuffing.

*See page 31 for directions on how to hard cook eggs.

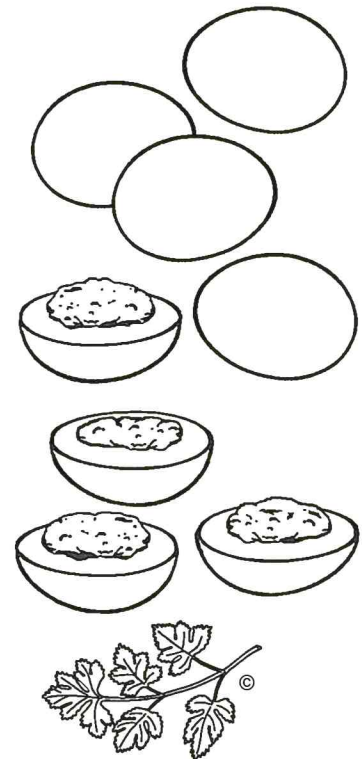

Baked Potatoes

Ingredients

1 potato for each person
Melted butter, margarine, or oil
(optional)

Equipment

Vegetable brush
Small bowl
Fork
Hot pads
Knife

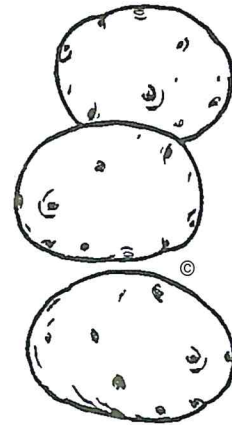

Order of Work

1. Preheat oven to 425 degrees F.
2. Select large potatoes about the same size.
3. Scrub the potatoes with a vegetable brush until clean.
4. Lightly coat the potatoes with melted butter, margarine, or oil if you want a tender, soft skin. For a crisp skin, do not use any fats.
5. Place potatoes on rack in oven. Bake about 45 to 60 minutes. Large potatoes take longer than small ones.
6. Potatoes are done when you can easily stick them with a fork. Another test is to squeeze the potato. Use hot pads when you test this way. If the potato is done, it will feel soft. Use hot pads to remove the potatoes from the oven — they're hot!
7. As soon as the potatoes are done, cut two crosswise slashes in the top and push firmly on the sides of the potato. This allows the steam to escape and prevents sogginess. Serve in an uncovered dish.

Easy Fresh Salsa

Ingredients

1 1/2 cups diced tomatoes
1/2 cup onion, finely diced
1/2 cup chopped fresh cilantro
2 tablespoons cider vinegar
1 teaspoon granulated sugar

Equipment

Cutting board
Sharp knife
Measuring cup and spoons
Small serving bowl

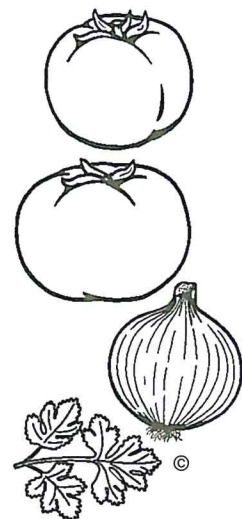

Order of Work

1. Combine all ingredients in a small serving bowl.
2. Best if made at least one hour before eating for best flavor.



MAIN DISHES

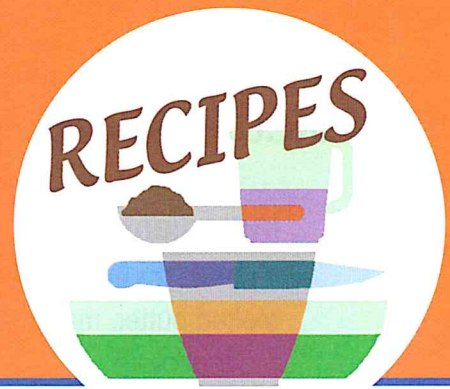

■ Egg Salad Filling

Yield: Filling for 3-4 sandwiches

Ingredients

- 4 eggs, hard-cooked
- 2 tablespoons pickle relish or chopped sweet pickles
- 3 tablespoons mayonnaise or salad dressing
- 1 teaspoon prepared mustard
- 1/2 teaspoon salt
- Dash of pepper

Equipment

- Cutting board
- Sharp knife for chopping or a pastry blender
- Mixing bowl
- Measuring spoons
- Scraper
- Cover for bowl
- Table fork

Order of Work

1. Finely chop hard-cooked eggs. You can use a knife and cutting board, or place the eggs in the mixing bowl and chop them with a pastry blender.
2. Place the finely chopped eggs in the mixing bowl.
3. Measure the relish or chop and measure the pickle and add it to the chopped eggs.
4. Add measured mayonnaise or salad dressing and the mustard, salt, and pepper.
5. Mix all ingredients together lightly, using a table fork.
6. Cover the bowl and refrigerate the egg salad until you are ready to use.

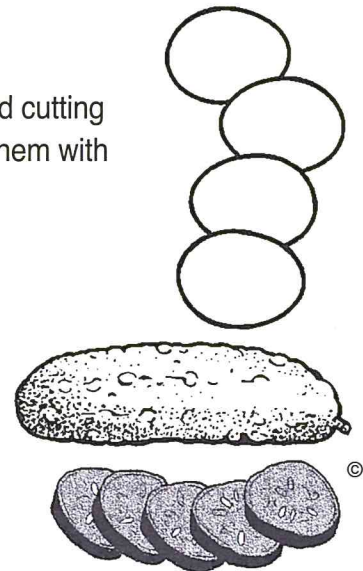

French Toast

Yield: 8 slices

Ingredients

3/4 cup milk
 1/4 to 1/2 teaspoon salt
 4 eggs
 8 slices bread
 Butter or margarine for cooking

Equipment

Knife to break egg
 Small bowl
 Fork
 Medium bowl or pie pan
 Measuring cup
 Measuring spoons
 Turner
 Griddle or large skillet

Order of Work

1. Place milk and salt in medium bowl.
2. Break egg into small bowl. An easy way to break an egg is to give it a sharp rap with the edge of a knife. Add egg to milk. Break the second egg into the bowl. Then add second egg to the milk. Repeat for remaining eggs.
3. Use a fork to beat the eggs, salt, and milk together.
4. Heat the griddle or skillet. For an electric skillet, set the temperature control at 360 degrees F. To test if the skillet is hot enough, sprinkle a few drops of water on it. If the water dances, the skillet is hot enough. Melt 1 or 2 tablespoons of butter or margarine in the skillet. If the butter or margarine begins to burn or smoke, the skillet is too hot; lower the heat.
5. Place one slice of bread in the milk mixture. Use a turner to turn the bread so that both sides are coated with mixture. Place coated bread in the hot skillet. Repeat until the skillet is full. Pieces may touch but should not be on top of each other.
6. Cook until bread is brown. Turn and brown it on the other side. Add more butter or margarine if the bread sticks to the pan.
7. Place the French toast on a warm plate.
8. Add more butter or margarine to the skillet if needed. Repeat steps 5, 6, and 7 until all the bread has been cooked.
9. Serve the French toast hot. Serving suggestions: sprinkle with powdered sugar; sprinkle with cinnamon and sugar; top with jam, jelly, or applesauce; or top with your favorite syrup.

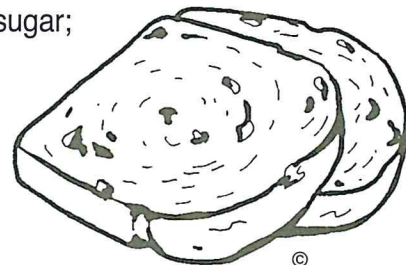

■ Better-than-Canned Chili

Yield: 6 servings

Ingredients

- 1 small onion
- 1 small green pepper, if desired
- 1 pound lean ground beef
- 1 can (15 1/2 oz.) kidney beans, drained and rinsed
- 1 can (15 oz.) tomato sauce
- 1 cup water or tomato juice
- 1 teaspoon chili powder
- 1/2 teaspoon salt

Equipment

- Measuring spoons
- Can opener
- Colander
- Sharp knife
- Cutting board
- 3-quart saucepan
- Measuring cups
- Large spoon
- Ladle
- Serving bowls

Order of Work

1. Use a sharp knife to peel and chop the onion on a cutting board. Wash the green pepper, if you are using one, and remove the seeds and stem and throw them away. Then chop it into small pieces.
2. Place the ground beef in the saucepan and break it up with a spoon. Add chopped onion and green pepper. Put the pan on a burner and turn the heat to medium.
3. Cook meat, onion, and green pepper slowly, about 10 to 15 minutes. As the meat cooks, use the spoon to break it into smaller pieces. Continue cooking until meat is lightly browned and thoroughly cooked. Turn off the burner.
4. With your helper, drain off the fat from the meat and throw it away.
5. Add the drained kidney beans, the tomato sauce, water or tomato juice, chili powder, and salt to the meat in the pan. Stir to mix well.
6. Turn burner to high heat. Cook and stir until mixture boils. Turn burner to low heat. Simmer, uncovered, for 10 minutes, stirring once in a while. Turn off the burner.
7. Ladle chili into bowls. Serve with your favorite toppings — shredded cheese, chopped tomatoes, green onions, etc.



■ Make Your Own Meat Sauce

Yield: 6 to 8 servings

Ingredients

- 1 small onion
- 1/4 green pepper (optional)
- 1 tablespoon butter, margarine, or oil
- 1 pound ground beef
- 4 cups canned tomatoes (pieces or juice)
- 1 can (8 oz.) tomato sauce
- 1 can (6 oz.) tomato paste
- 1/2 teaspoon salt
- 1/4 teaspoon pepper
- 1 tablespoon granulated sugar
- 1/4 teaspoon dried oregano (optional)

Equipment

- Cutting board
- Sharp knife
- Heavy skillet
- Kitchen fork
- Mixing spoon
- Colander
- Can opener
- Measuring spoons
- Scraper

Order of Work

1. Peel and chop the onion.
2. Wash and clean the green pepper. Place 1/4 green pepper on the cutting board and cut it into strips about 1/4-inch wide. Hold the strips together and cut them across several times to make pieces about 1/4-inch square.
3. Heat the butter, margarine, or oil in the skillet over medium heat. Add the onion and green pepper. Cook until the onion is golden in color and begins to look transparent. Stir gently as it cooks. Remove from heat.
4. Place the ground beef in the skillet with the onion and green pepper. Pull the meat apart with the kitchen fork.
5. Place the pan back over medium heat and cook, stirring most of the time with the fork to keep the meat separated. Cook until all of the meat is lightly browned.
6. Remove skillet from heat. Pour off extra fat. Be sure to ask someone to show you how to do this. Some ground meat contains more fat than other ground meat. You want to pour off the extra fat so the ground meat mixture will not taste greasy.
7. Add the tomatoes, tomato sauce, and tomato paste. Use the scraper to get all of the sauce and paste out of the cans. Stir to blend all the ingredients.
8. Add the salt, pepper, sugar, and oregano. Stir. Return the skillet to the heat.
9. Let the mixture come to a boil; then lower the heat so that the sauce just simmers. Let it simmer for about 30 minutes.
10. Before you serve the tomato-meat sauce, taste it to see if it is seasoned properly. Add more seasoning (salt, pepper, or sugar), if needed.

■ Pasta with Meat Sauce

Yield: 4 to 6 servings

Ingredients

1/2 pound lean ground beef or bulk Italian sausage
1 jar or can (26 to 32 oz.) spaghetti sauce
8 ounces uncooked pasta

Equipment

Very large saucepan or cooking pot
Skillet
Mixing spoons
Colander or large strainer

Order of Work

1. Place the meat in the skillet and follow steps 4, 5, and 6 from Make Your Own Meat Sauce to prepare meat.
2. Add the spaghetti sauce to the meat and stir well. Cover and cook over very low heat while cooking pasta.
3. To cook pasta, fill a large saucepan or pot with about 2 quarts (8 cups) of water. Place the pan on the stove and heat over high heat until water boils.
4. Slowly add pasta and cook uncovered, stirring occasionally to avoid sticking. Use a timer and follow package directions for cooking time.
5. Have an adult help with this step. Place a colander or strainer in or over a sink with an open drain. Use hot pads to remove hot pan from stove. Pour pasta into the strainer. Pour away from your body to avoid a steam burn.
6. Sauce can be tossed with the pasta in the pot used for cooking, or sauce can be spooned over the pasta on plates.

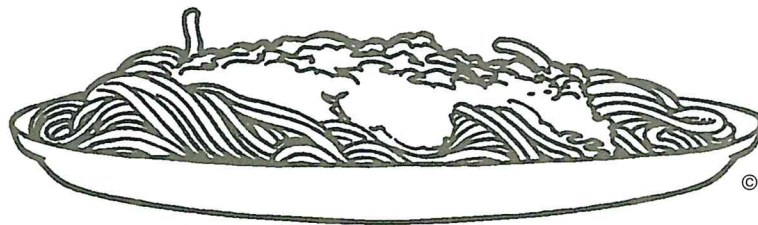

QUICK BREADS

RECIPES

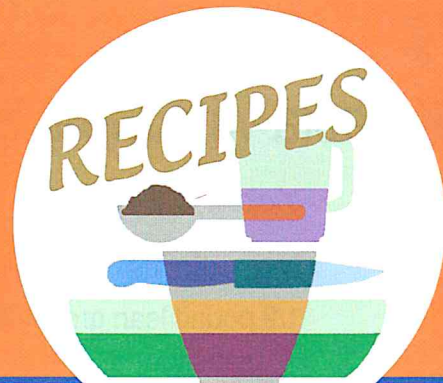

■ Carol's Oatmeal Muffins

Yield: 10 - 12 muffins

Ingredients

- 1 1/3 cups all-purpose flour
- 3/4 cup rolled oats, quick cooking or regular
- 1/3 cup granulated sugar
- 2 teaspoons baking powder
- 1/4 teaspoon salt
- 1 egg
- 3/4 cup milk
- 1/4 cup oil

Equipment

- Non-stick cooking spray
- Large mixing bowl
- Mixing spoon
- Measuring cups
- Measuring spoons
- Small bowl and fork
- Muffin pan
- Wire rack
- Hot pads



Order of Work

1. Preheat the oven to 400 degrees F. Lightly coat the muffin pan with non-stick cooking spray.
2. Measure flour, oatmeal, sugar, baking powder, and salt into the large bowl. Mix with a spoon.
3. Break the egg into the small bowl and beat it lightly with the fork. Then stir in the vegetable oil and milk.
4. Add the egg mixture to the dry mixture in the large bowl.
5. With a large spoon, mix only about 25 times, just enough to get the dry ingredients wet. The dough is supposed to be lumpy. If you mix too much, your muffins will be tough.
6. Carefully spoon the batter into prepared muffin pan. Fill each cup two-thirds full.
7. Bake for 20 minutes or until golden brown. Remove pan from the oven with hot pads. Let muffins cool slightly; then remove them from the pan and place them on a wire rack to cool.



MUFFINS

How do your muffins rate?

Look at the outside

- Are they a golden brown color?
- Are the tops gently rounded?
- Are the tops pebbly rather than smooth?

Look at the inside

- Is the texture slightly moist?
- Are they free from air tunnels?
- Is the texture uniform?
- Are they easily broken?

Now taste it

- Do they taste slightly sweet?

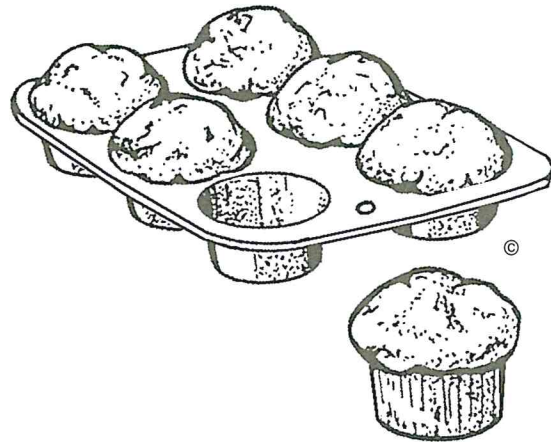

Cornbread

Yield: About 12 squares

Ingredients

- 1 cup sifted all-purpose flour
- 3/4 cup cornmeal
- 1 teaspoon salt
- 2 1/2 teaspoons baking powder
- 1/4 cup granulated sugar
- 1 egg
- 1 cup milk
- 1/4 cup vegetable oil

Equipment

- Non-stick cooking spray
- Flour sifter
- Waxed paper
- Measuring cups
- Spatula or knife
- Measuring spoons
- Mixing bowls, 1 large, 1 small
- Whisk or fork
- Mixing spoon
- Scraper
- Baking pan (8"x8" or 9"x9")
- Wire rack

Order of Work

1. Preheat the oven to 425 degrees F.
2. Lightly coat the baking pan with non-stick cooking spray, including the sides, or the cornbread will stick and won't come out easily.
3. Sift flour once; then measure it.
4. Combine flour, cornmeal, salt, baking powder, and sugar in large bowl and stir until well mixed.
5. Break the egg into the small bowl and beat with a whisk or fork.
6. Measure the milk and add it to the egg.
7. Measure the vegetable oil. Add it to the egg and milk.
8. Pour the egg-milk-oil mixture into the flour mixture and stir. Scrape sides of bowl. Then stir until barely mixed. (Batter will look lumpy.)
9. Put into the prepared pan. (Use the rubber scraper to get it out of the bowl.)
10. Put into the preheated oven.
11. Bake about 25 minutes. The cornbread is done when the top is a light, golden color, begins to pull away from the edge of the pan, and springs back when lightly touched.
12. Remove the cornbread from the oven using hot pads.
13. Cut into pieces while it is still in the pan.
14. Remove cornbread from pan using a spatula or turner. Serve warm.

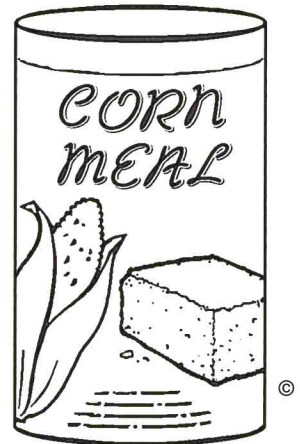

CORNBREAD

How does your cornbread rate?

Look at the outside

- Is it almost even in thickness with a slightly rounded top (no humps, peaks, or cracks)?
- Is the crust thin and even?
- Is the cornbread an even, light color?

Look at the inside

- Does it have round, even cells and no tunnels?
- Does it have a tender, moist crumb (not dry or soggy)?

Now taste it

- Does it taste good?
- Does it have the flavor of well-blended ingredients with no taste of salt, soda, fat, or any other ingredient?

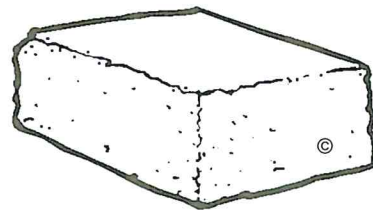

Drop Biscuits

Yield: 12 biscuits

Ingredients

- 2 cups sifted all-purpose flour
- 2 1/2 teaspoons baking powder
- 1 teaspoon salt
- 5 tablespoons butter or margarine,
chilled (not reduced fat)
- 3/4 cup milk

Equipment

- Flour sifter
- Measuring cups
- Spatula
- Measuring spoons
- Mixing bowl
- Fork or pastry blender
- 2 spoons
- Rubber scraper
- Cookie sheet

Order of Work

1. Preheat the oven to 425 degrees F.
2. Sift flour once and then measure it. Add to mixing bowl.
3. Add baking powder and salt to the mixing bowl. Stir.
4. Measure the fat and add to the flour mixture.
5. Cut the fat into the flour mixture with the fork or pastry blender until well mixed.
Ask someone to show you how to do this.
6. Make a hole in the center of the flour. Pour milk into the hole.
7. Stir with a fork until the dough is soft and sticky.
8. Drop by spoonfuls on the cookie sheet. Use one spoon to dip out the dough and the other to push the dough onto the cookie sheet. Leave about 2 inches between biscuits on the cookie sheet.
9. Bake for about 15 minutes. The biscuits will be a light, golden color when they are done.
10. Remove the biscuits from the oven. Use hot pads because the cookie sheet is hot.
11. Serve warm.

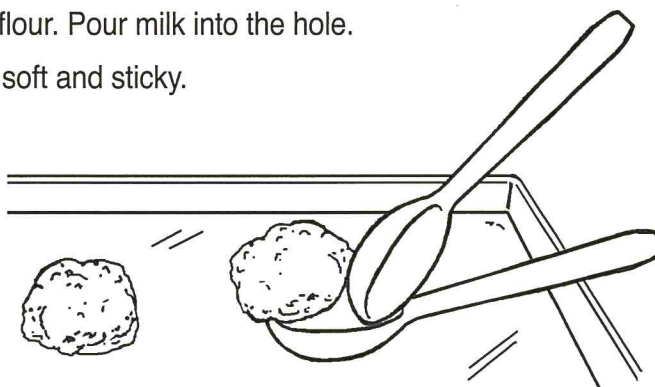

■ Make Your Own Pancakes

Yield: 10 to 12 medium size pancakes

Ingredients

- 1 1/4 cups all-purpose flour
- 2 teaspoons baking powder
- 3/4 teaspoon salt
- 1 tablespoon granulated sugar
- 1 egg
- 1 cup milk
- 2 tablespoons butter or margarine, melted (not reduced fat); or 2 tablespoons vegetable oil
- 1/2 to 1 cup fresh or frozen blueberries (optional)

Equipment

- Measuring cups
- Measuring spoons
- Small bowl
- Mixing bowl
- Knife to break egg
- Fork
- Whisk
- Large spoon
- Turner
- Griddle or skillet

Order of Work

1. Place measured flour, baking powder, salt, and sugar in the mixing bowl. Use a fork to mix the ingredients together.
2. Break the egg into the small bowl.
3. Make a hole in the center of the dry ingredients. Pour the unbeaten egg and the milk into the hole.
4. Beat with a whisk or spoon until mixed. Then add the melted butter, margarine, or oil. Add blueberries, if desired. Beat only until smooth.
5. Cook the pancakes according to the directions given in Pancakes From a Mix. See steps 5 to 9 on next page.

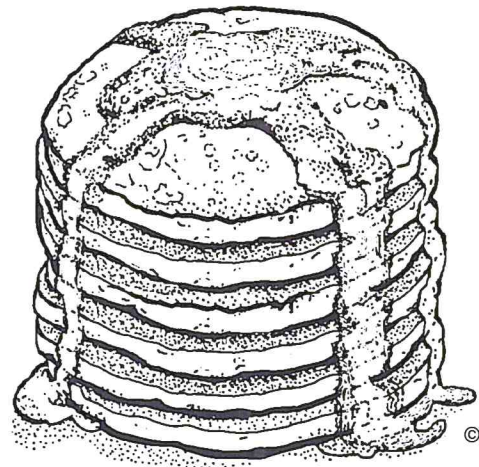

Pancakes From a Mix

Ingredients

Pancake mix
Additional ingredients listed on
package label

Equipment

Mixing bowl
Mixing spoon
Measuring cup
Griddle or skillet
Turner
Plate

Order of Work

1. Read instructions on the package label and decide what quantity you want to make.
2. Get out all the ingredients and equipment called for in the recipe.
3. Measure the mix into a bowl. Carefully measure other ingredients to go into the mix.
4. Mix according to directions given on the package label.
5. Heat the heavy griddle or skillet. To test if the skillet is hot enough, sprinkle a few drops of water on it. If the water dances, the skillet is hot enough. Melt 1 or 2 tablespoons of butter or margarine in the skillet. If you are using an electric appliance, set the temperature at 375 degrees F.
6. Use a large spoon for pouring batter on the hot griddle. Pour the batter from the tip of the spoon so that the pancake will be round. Another way is to pour the batter from a small measuring cup or pitcher.
7. The pancake is ready to turn when you can see bubbles on the edges that are just beginning to break. Lift the pancake with a turner and look to see if the undersurface is brown. When brown, turn the pancake over so the other side will cook and brown.
8. Make a small test pancake before you cook all the pancakes. If the pancake is too thick for your family's taste, you can add a tablespoon or more of milk to the batter. If the pancake is too thin to suit your family, add a tablespoon or more of pancake mix to the batter.
9. Place pancakes on a warm plate. Serve immediately with butter or margarine and syrup, jelly, jam, or apple sauce.

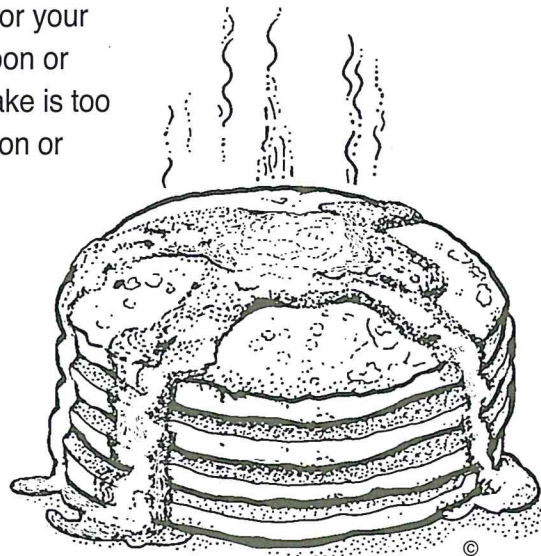

DESSERTS

RECIPES

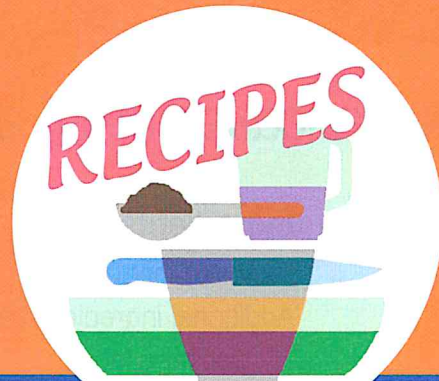

■ Baked Apples

Yield: 4 servings

Ingredients

- 4 apples
- 1/4 cup packed brown sugar
- 2 teaspoons butter or margarine
- Cinnamon
- 1 cup water

Equipment

- Apple corer
- Measuring cup
- Measuring spoons
- Covered baking dish
- Hot pads

Order of Work

1. Preheat oven to 375 degrees F.
2. Rinse apples in cold water and remove the cores. Get someone to show you how to core an apple.
3. Place cored apples in baking dish. Fill holes with brown sugar and butter or margarine. Pour water around the apples. Sprinkle cinnamon on top. Place cover on dish.
4. Bake about 40 to 50 minutes. Apples that are small or that have been stored several months may bake in about 30 minutes. Apples that are very large or hard or that have been stored only a short time may take an hour to bake. Apples are done when they can be pierced easily with the tip of a paring knife. Be sure to use hot pads when you remove the cover, and tip the cover toward you so the steam will escape away from you. If apples are not done, bake them longer.

You can also fill the holes with raisins, chopped dates, nuts, or a combination of these. If you like apples that are sweet, add 1/4 cup of sugar to the water.

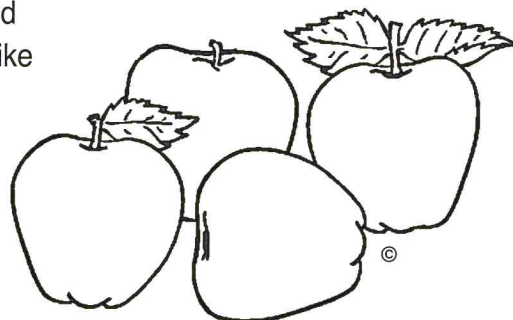

Cherry Jumble

Yield: 9 servings

Ingredients

1 can (14 to 16 oz.) sour unsweetened
red cherries (about 2 cups)
1 tablespoon butter or margarine
1/2 cup granulated sugar
1/8 teaspoon cinnamon

Dough mixture:

1 cup all-purpose flour
1/2 cup sugar
1 teaspoon baking powder
1/2 teaspoon salt
2 tablespoons butter or margarine
(not reduced fat)
1/2 cup water

Order of Work

1. Preheat the oven to 375 degrees F.
2. Lightly coat the baking pan with non-stick cooking spray.
3. Open can of cherries. Pour cherries and juice into a small saucepan. Add butter, sugar, and cinnamon. Bring to a boil. Remove from heat.
4. Measure flour.
5. Place flour in a bowl with sugar, baking powder, and salt. Stir together. Add fat and mix with a pastry blender or fork. (Ask someone to show you how.)
6. Add water to flour mixture. Stir only until lightly blended.
7. Spread dough evenly in baking dish. Spoon hot cherry mixture evenly over the top. It's hot so use hot pads and be careful putting it in the oven.
8. Bake about 20 to 30 minutes. Cake should spring back when touched gently with the fingers.
9. Serve warm with cream, ice cream, or plain.

Equipment

Non-stick cooking spray
Baking pan (8"x8")
Can opener
Small saucepan
Measuring spoons
Measuring cups
Spatula or knife
Fork or pastry blender
Mixing bowl
Scraper
Hot pads

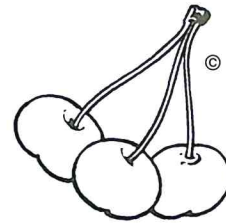

Fruit Crisp

Yield: 6 servings

Ingredients

- 1 cup rolled oats, quick-cooking or regular
- 1/2 cup all-purpose flour
- 1/2 cup firmly packed brown sugar
- 1/4 teaspoon salt
- 1 teaspoon cinnamon
- 1/2 cup (1 stick) butter or margarine, softened (not reduced fat)
- 4 cups fresh or frozen fruit such as sliced apples, peaches, apricots, blueberries, or rhubarb

Equipment

- Medium-sized mixing bowl
- Measuring cups and spoons
- Knife
- Pastry blender, fork or 2 knives
- 2-quart baking dish or 8"x8" baking pan
- Potholder
- Non-stick cooking spray

Order of Work

1. Preheat oven to 350 degrees F.
2. Lightly coat baking dish with non-stick cooking spray.
3. Place rolled oats, flour, brown sugar, salt, and cinnamon in the bowl and mix to blend.
4. Add softened butter or margarine and blend well with pastry blender, fork or 2 knives.
5. Arrange fruit in prepared baking dish.
6. Spread oatmeal mixture on top of fruit and press down lightly.
7. Bake about 30 minutes or until topping is brown.
8. Serve warm or cold with milk or ice cream.

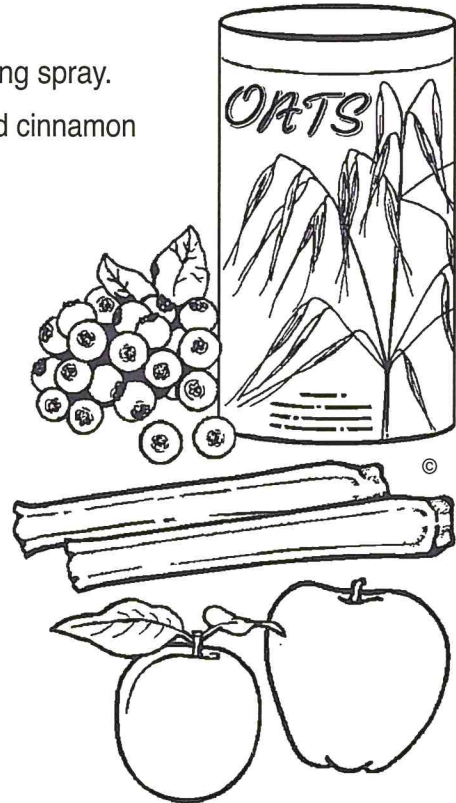

■ Peanut Butter Kisses

Yield: About 36 candies

Ingredients

- 1/3 cup honey* or dark corn syrup or jelly
- 1/3 cup chunky or smooth peanut butter
- 1 cup instant nonfat dry milk
- 1/2 cup finely crushed ready-to-eat cereal flakes

Equipment

- Mixing bowl
- Measuring cups
- Scraper
- Mixing spoon
- Waxed paper

Order of Work

1. Measure honey or corn syrup or jelly and peanut butter. Place in bowl. Stir until blended.
2. Blend dry milk powder gradually into peanut butter mixture. The last of the milk may have to be mixed by hand.
3. Shape into small balls about 1/2 inch in diameter or shape into one long log.
4. Place cereal crumbs on clean waxed paper. Roll balls or log in crumbs until the candy is coated. Put candy balls in a container or wrap the log in waxed paper. Chill the log well before cutting into slices.
5. Refrigerate leftovers.

* If honey is used, do not allow infants less than one year of age to eat these. Honey can be harmful to infants.



■ Oatmeal Drop Cookies

Yield: 3 1/2 dozen cookies

Ingredients

- 1 cup sifted all-purpose flour
- 1/2 teaspoon baking powder
- 1/2 teaspoon baking soda
- 1/2 teaspoon salt
- 1/2 cup granulated sugar
- 1/2 cup firmly packed brown sugar
- 1/2 cup butter, margarine, or shortening,
softened (not reduced fat)
- 1 tablespoon water
- 1/2 teaspoon vanilla
- 1 egg
- 1 1/2 cups regular or quick oatmeal,
uncooked

Equipment

- Non-stick cooking spray
- Flour sifter
- Waxed paper
- Measuring cups
- Measuring spoons
- Mixing bowl
- Mixing spoon
- 2 teaspoons
- Scraper
- Cookie sheet
- Turner
- Hot pads
- Wire racks
- Small bowl
- Knife or spatula

Order of Work

1. Preheat the oven to 350 degrees F.
2. Lightly coat the cookie sheet with non-stick cooking spray.
3. Sift flour once, then measure it. Add to mixing bowl.
4. Measure the baking powder, baking soda, and salt. Add to the flour and stir.
5. Measure and add the sugar, brown sugar, fat, water, and vanilla.
6. Break the egg into the small bowl, then add it to the other ingredients.
7. Beat the mixture until it looks smooth. Be sure to stir all the way to the bottom of the bowl.
8. Measure the oatmeal and stir it in. Be sure it is mixed throughout the batter.
9. Drop by spoonfuls on prepared cookie sheet. To do this, dip out a rounded teaspoon of dough and use the other teaspoon to push the dough onto the cookie sheet. Leave about 2 inches between cookies. Use scraper to clean out bowl.
10. Bake at 350 degrees F for 12 to 15 minutes. The cookies will be a light golden color when they are done and should spring back when lightly touched with the fingers.
11. Take cookies out of the oven. Use hot pads because the cookie sheet is hot.
12. Use a spatula or turner to remove the hot cookies from the sheet. Place them on a rack to cool. Cool cookie sheet before filling again. When cookies are cool, store in a container with a tight lid.

To make raisin oatmeal cookies, add 1/2 cup of seedless raisins when you add the oatmeal. For gumdrop oatmeal cookies, add 1/2 cup of gumdrops, cut fine. For chocolate-chip oatmeal cookies, add 1/2 to 3/4 cup of chocolate chips.

■ Jackpot Drop Cookies

Yield: 3 dozen cookies

Ingredients

- 1 1/4 cups sifted all-purpose flour
- 1 teaspoon baking soda
- 1 teaspoon baking powder
- 1 egg
- 1/2 cup (1 stick) butter or margarine,
softened (not reduced fat)
- 1/2 cup granulated sugar
- 1/2 cup firmly packed brown sugar
- 1 teaspoon vanilla
- 1 cup rolled oats, quick-cooking or regular
- 1/2 cup chocolate chips and/or 1/2 cup
raisins, chopped dates or nuts, if desired

Equipment

- Non-stick cooking spray
- Flour sifter
- Waxed paper
- Measuring cups and spoons
- Straight-edged knife
- Mixing bowls, one small, one large
- Mixing spoon
- Mixer
- Cookie sheets
- Rubber scraper
- Cooling racks
- Potholders
- Turner

Order of Work

1. Preheat oven to 350 degrees F. Lightly coat the cookie sheet with non-stick cooking spray.
2. Sift flour and measure 1 1/4 cups. Add to small mixing bowl.
3. Add the baking soda and baking powder to flour. Stir. Set aside.
4. Break egg and add to large mixing bowl.
5. Add butter or margarine, sugar, brown sugar, and vanilla to large mixing bowl and beat thoroughly with mixer.
6. Add flour mixture and mix well.
7. Add rolled oats and chocolate chips (also raisins, nuts or dates, if used). Stir by hand until mixed.
8. Drop dough by teaspoonfuls on prepared cookie sheet about 2 inches apart. Use 1 teaspoon to dip out cookie dough and a second teaspoon to push dough off.
9. Bake for 10 to 12 minutes. The cookies will be a golden brown when they are done. They should be soft when you touch them lightly with your finger.
10. Cool cookies slightly. Remove cookies from pan with a turner. Place on racks.
11. When cool, store in container with tight lid.

Chocolate Crinkles

Yield: 4 dozen cookies

Ingredients

2 one-ounce squares unsweetened chocolate, melted
 1/2 cup butter or margarine (not reduced fat)
 1 2/3 cups granulated sugar
 2 teaspoons vanilla
 2 eggs
 2 cups sifted all-purpose flour
 2 teaspoons baking powder
 1/2 teaspoon salt
 1/3 cup milk
 1/2 cup chopped nuts
 Sifted confectioners' sugar

Equipment

Non-stick cooking spray
 Mixing bowls, 1 large, 1 small
 Measuring cups, liquid and dry
 Measuring spoons
 Mixing spoon
 Straight-edged knife
 Flour sifter
 Waxed paper
 Knife and cutting board (or nut chopper)
 Rubber scraper
 Cookie sheets
 Potholders
 Cooling racks
 Turner

Order of Work

1. Place chocolate in small microwave-safe bowl. Microwave on 50% power for 30 to 40 seconds until chocolate is melted. Stir. Set aside to cool.
2. Using the mixer, cream together the butter or margarine, sugar, and vanilla.
3. Break one egg into small bowl. Add egg to sugar mixture and mix well. Break second egg into small bowl. Add second egg to sugar mixture. Mix until creamy.
4. Add cooled chocolate to sugar mixture. Mix until well blended.
5. Sift and measure flour. Add to small mixing bowl. Add baking powder and salt to flour and stir well.
6. Add half dry ingredients to sugar mixture with all of the milk. Mix until blended. Add remaining dry ingredients. Mix until blended.
7. Chop nuts with nut chopper or use a cutting board and knife. Add nuts to dough and mix until blended.
8. Chill mixture for 3 hours in refrigerator.
9. Preheat oven to 350 degrees F.
10. Lightly coat the cookie sheet with non-stick cooking spray.
11. Pinch off small pieces of dough and form into 1-inch balls. Roll balls in confectioners' sugar.
12. Place on prepared cookie sheet 2 or 3 inches apart.
13. Place cookie sheet in center of oven. Bake about 13 to 15 minutes.
14. Cool cookies slightly. Remove from the cookie sheet with a turner and place on racks to cool. When cool, store cookies in container with a tight lid.



COOKIES

To make evenly browned cookies, the oven heat must be able to flow around the cookie sheet. If the sheet is too big, the heat cannot flow evenly. If one cookie sheet is placed directly over the other in the oven, heat is not evenly distributed. Cookies baked in the lower half of the oven will be browner on the bottom than on the top, and those baked in the upper half will be browner on the top than on the bottom of the cookies.

How do your cookies rate?

After baking your cookies, use these questions to see if they look and taste the way they should.

Look at the outside

- Are the cookies all about the same size?
- Do your bar cookies have a nearly level top?
- Do your drop cookies have a slightly rounded top?
- Do they have an even color (no dark brown edges or burned spots, not pale or overly browned)?

Look at the inside

- Does the cookie or bar have small, even holes?
- Does it appear to have a thin delicate crust?
- Does the inside appear slightly moist rather than dry and crumbly?

Now taste it

- Does it have a good flavor? (It should not taste strongly of any one ingredient, such as fat, flavoring, or baking powder.)
- Is it crisp, crunchy, chewy, or soft and tender?
- Does it taste as though it had baked for the right length of time?

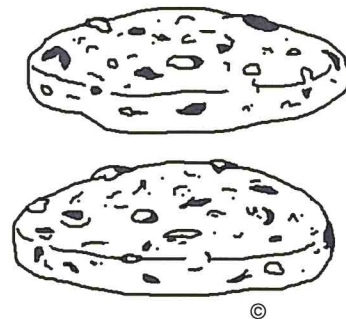

Quick-Mix Yellow Cake

Yield: 9 to 12 servings

Ingredients

- 1 1/3 cups sifted all-purpose flour
- 1 cup granulated sugar
- 1/3 cup margarine, softened (not reduced fat)
- 2/3 cup milk
- 2 1/4 teaspoons baking powder
- 1/2 teaspoon salt
- 1 teaspoon vanilla
- 2 eggs

Equipment

- Non-stick cooking spray
- Baking pan, 9"x9" or 8"x8"
- Flour Sifter
- Large mixing bowl
- Measuring cups
- Measuring spoons
- Electric mixer
- Rubber spatula (scraper)
- Wire rack
- Hot pads

Order of Work

1. Preheat oven to 350 degrees F.
2. Lightly coat the baking pan with non-stick cooking spray. Then flour the pan.
3. Sift and measure flour. Add to large mixing bowl. Measure all remaining ingredients into the large mixing bowl.
4. Beat on medium speed until blended, about 30 seconds, scraping sides of the bowl with a spatula.
5. Beat on high speed, scraping bowl occasionally, for 3 minutes. *(don't over beat)*
6. Pour batter into prepared baking pan, using a spatula to scrape batter from the sides of the bowl into the pan. Spread the batter evenly. *+ tap bottom of pan to bring bubbles up & smooth out*
7. Bake at 350 degrees F for about 30 minutes. When it is done, the cake will spring back when lightly touched and will begin to pull away from the edge of the pan. The top will be a golden brown.
8. Use hot pads to take the cake out of the oven.
9. Put the cake on a rack to cool. Add topping or icing if desired.

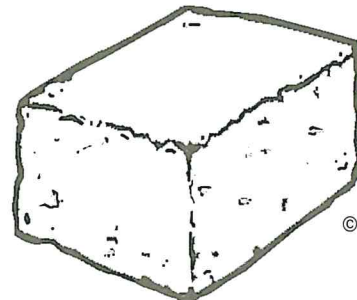

CAKES

Cakes from packaged mixes are quick to make, good tasting, and sometimes less expensive than making a cake completely from individual ingredients. For this project make some cakes using packaged mixes and try the Quick Yellow Cake recipe in this book. When using cake mixes, carefully follow the directions on the package. It is just as important to measure accurately and use the right size pan, baking temperature and time when using mixes as it is when baking from a recipe.

When your cake is finished baking, use the following guide to rate the appearance and taste of the cake.

How does your cake rate?

Look at the outside

- Is it almost even in thickness with a slightly rounded top (no lumps, peaks, or cracks)?
- Is it an even, lightly browned color?
- Does it have a tender, smooth crust?

Look at the inside

- Does it have a tender, moist crumb?
- Does it have an even texture, free of tunnels?
- Does it seem light and fluffy?
- Does it have an attractive, even color?

Now taste it

- Does it taste good?
- Does it have any off flavor?

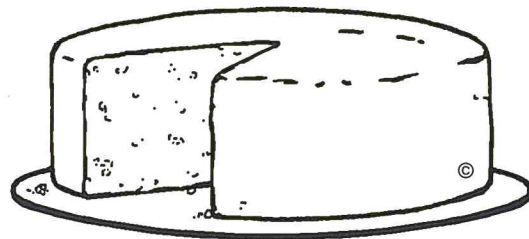



NUTRITION FACTS

- The recipes were analyzed using Food Processor SQL 10.5.
- 2% milk was used unless another kind of milk was specified in the recipe.
- When a range was given for ingredient amount or number of servings, the largest number was used in the analysis.
- When options were listed for ingredients in a recipe, the first ingredient listed was analyzed.
- Codes for Nutrition Facts:
g = gram
mg = milligram
- All the recipes in this book were tested by University of Illinois Extension Nutrition and Wellness Educators.



Snacks

Make Your Own Cocoa Mix

Nutrition Facts per Serving: 166 calories, 1 g fat, 124 mg sodium, 33 g carbohydrate, 1 g fiber, 9 g protein, 279 mg calcium

Cereal-Marshmallow Bars

Nutrition Facts per Bar: 80 calories, 2 g fat, 88 mg sodium, 15 g carbohydrate, less than 1 g fiber, 1 g protein, less than 1 mg calcium

Chewy Granola Bars

Nutrition Facts per Bar: 242 calories, 10 g fat, 60 mg sodium, 35 g carbohydrate, 2 g fiber, 4 g protein, 26 mg calcium

Quick Veggie Pizza

Nutrition Facts per Serving: 146 calories, 8 g fat, 346 mg sodium, 13 g carbohydrate, 2 g fiber, 7 g protein, 188 mg calcium

Shake It Up Pudding

Nutrition Facts per Serving (adding 1 banana): 144 calories, 2 g fat, 326 mg sodium, 28 g carbohydrate, 1 g fiber, 3 g protein, 118 mg calcium



Fruity Shake

Nutrition Facts per Serving: 205 calories, 3 g fat, 53 mg sodium, 40 g carbohydrate, 4 g fiber, 6 g protein, 176 mg calcium

Mexican Layered Dip

Nutrition Facts per Serving (with 1 oz low-fat tortilla chips): 249 calories, 6 g fat, 633 mg sodium, 36 g carbohydrate, 6 g fiber, 12 g protein, 338 mg calcium

Pocket Sandwiches

Nutrition Facts per Serving (using a 6½-inch pita bread round): 309 calories, 7 g fat, 1162 mg sodium, 40 g carbohydrate, 5 g fiber, 22 g protein, 128 mg calcium

Zoo Snacks

Nutrition Facts per Serving: 258 calories, 13 g fat, 212 mg sodium, 34 g carbohydrate, 2 g fiber, 4 g protein, 55 mg calcium

Breakfast Sundae

Nutrition Facts per Serving: 173 calories, 1 g fat, 65 mg sodium, 37 g carbohydrate, 1 g fiber, 4 g protein, 102 mg calcium

 **Side Dishes**
The Best Applesauce

Nutrition Facts per Serving: 47 calories, less than 1 g fat, 1 mg sodium, 12 g carbohydrate, 1 g fiber, less than 1 g protein, 7 mg calcium

Magical Fruit Salad

Nutrition Facts per Serving: 125 calories, 1 g fat, 203 mg sodium, 28 g carbohydrate, 1 g fiber, 2 g protein, 67 mg calcium

Fruity Fruit Salad

Nutrition Facts per Serving: 113 calories, less than 1 g fat, 66 mg sodium, 28 g carbohydrate, 1 g fiber, 2 g protein, 4 mg calcium

Make Your Own Salad Bar

Nutrition Facts per Serving (used spinach and other fresh vegetables suggested but without dressing): 15 calories, less than 1 g fat, 24 mg sodium, 3 g carbohydrate, 1 g fiber, 1 g protein, 28 mg calcium

Scalloped Corn

Nutrition Facts per Serving: 176 calories, 4 g fat, 629 mg sodium, 34 g carbohydrate, 2 g fiber, 5 g protein, 36 mg calcium

Easy-to-Fix Green Beans

Nutrition Facts per Serving: 101 calories, 5 g fat, 723 mg sodium, 12 g carbohydrate, 3 g fiber, 3 g protein, 70 mg calcium

Carrot-Raisin Salad

Nutrition Facts per Serving (using 7-inch carrots): 201 calories, 7 g fat, 186 mg sodium, 34 g carbohydrate, 3 g fiber, 2 g protein, 36 mg calcium

Deviled Eggs

Nutrition Facts per Egg Half: 53 calories, 4 g fat, 97 mg sodium, less than 1 g carbohydrate, less than 1 g fiber, 3 g protein, 13 mg calcium

Baked Potatoes

Large russet (3 – 4¼ inch)

Nutrition Facts per Potato (using 1 tsp butter): 323 calories, 4 g fat, 74 mg sodium, 64 g carbohydrate, 7 g fiber, 8 g protein, 54 mg calcium

Medium russet (2¼ – 3¼ inch)

Nutrition Facts per Potato (using 1 tsp butter): 202 calories, 4 g fat, 42 mg sodium, 38 g carbohydrate, 3 g fiber, 5 g protein, 28 mg calcium

Easy Fresh Salsa

Nutrition Facts per Serving (4 servings): 23 calories, less than 1 g fat, 6 mg sodium, 5 g carbohydrate, 1 g fiber, 1 g protein, 12 mg calcium



Main Dishes

Egg Salad Filling

Nutrition Facts per Filling for Sandwiches: 147 calories, 13 g fat, 539 mg sodium, less than 1 g carbohydrate, less than 1 g fiber, 6 g protein, 27 mg calcium

French Toast

Nutrition Facts per Slice (using wheat bread and 2 tablespoons butter): 139 calories, 7 g fat, 344 mg sodium, 13 g carbohydrate, 1 g fiber, 7 g protein, 76 mg calcium

Better-than-Canned Chili

Nutrition Facts per Serving: 243 calories, 8 g fat, 622 mg sodium, 21 g carbohydrate, 8 g fiber, 22 g protein, 25 mg calcium

Sloppy Joes

Nutrition Facts per Sandwich (using lean ground beef and whole wheat buns): 230 calories, 8 g fat, 695 mg sodium, 26 g carbohydrate, 4 g fiber, 16 g protein, 61 mg calcium



Make Your Own Meat Sauce

Nutrition Facts per Serving (using lean ground beef): 173 calories, 7 g fat, 762 mg sodium, 13 g carbohydrate, 3 g fiber, 14 g protein, 42 mg calcium

Pasta with Meat Sauce

Nutrition Facts per Serving (using lean ground beef): 279 calories, 6 g fat, 741 mg sodium, 46 g carbohydrate, 5 g fiber, 15 g protein, 61 mg calcium

Quick Breads
Carol's Oatmeal Muffins

Nutrition Facts per Muffin: 148 calories, 6 g fat, 152 mg sodium, 21 g carbohydrate, 1 g fiber, 3 g protein, 42 mg calcium

Cornbread

Nutrition Facts per Serving: 144 calories, 6 g fat, 323 mg sodium, 20 g carbohydrate, 1 g fiber, 3 g protein, 49 mg calcium

Drop Biscuits

Nutrition Facts per Biscuit: 127 calories, 5 g fat, 355 mg sodium, 17 g carbohydrate, 1 g fiber, 3 g protein, 42 mg calcium

Coffeecake With Topping

Nutrition Facts per Serving: 148 calories, 7 g fat, 224 mg sodium, 21 g carbohydrate, 1 g fiber, 2 g protein, 41 mg calcium

Make Your Own Pancakes

Nutrition Facts per Pancake: 93 calories, 3 g fat, 267 mg sodium, 14 g carbohydrate, 1 g fiber, 3 g protein, 45 mg calcium

Pancakes From a Mix

(See Nutrition Facts on package)

Desserts
Baked Apples

Nutrition Facts per Serving: 151 calories, 2 g fat, 22 mg sodium, 36 g carbohydrate, 5 g fiber, less than 1 g protein, 20 mg calcium

Cherry Jumble

Nutrition Facts per Serving (made with butter): 191 calories, 4 g fat, 227 mg sodium, 38 g carbohydrate, 1 g fiber, 2 g protein, 20 mg calcium

Fruit Crisp

Nutrition Facts per Serving (using peeled medium apples): 333 calories, 16 g fat, 229 mg sodium, 45 g carbohydrate, 3 g fiber, 3 g protein, 35 mg calcium

Easy-to-Fix Cream Pie with Crumb Crust

Nutrition Facts per Serving (using chocolate pudding with 2 cups milk): 333 calories, 14 g fat, 319 mg sodium, 48 g carbohydrate, 2 g fiber, 5 g protein, 122 mg calcium

Peanut Butter Kisses

Nutrition Facts per Candy: 33 calories, 1 g fat, 30 mg sodium, 5 g carbohydrate, less than 1 g fiber, 1 g protein, 27 mg calcium

Brownies

Nutrition Facts per Square: 137 calories, 7 g fat, 40 mg sodium, 18 g carbohydrate, 1 g fiber, 2 g protein, 6 mg calcium

Oatmeal Drop Cookies

Nutrition Facts per Cookie: 63 calories, 2 g fat, 70 mg sodium, 9 g carbohydrate, less than 1 g fiber, 1 g protein, 7 mg calcium

Peanut Butter Cookies

Nutrition Facts per Cookie: 84 calories, 4 g fat, 65 mg sodium, 10 g carbohydrate, less than 1 g fiber, 2 g protein, 6 mg calcium

Jackpot Drop Cookies

Nutrition Facts per Cookie: 88 calories, 4 g fat, 74 mg sodium, 13 g carbohydrate, 1 g fiber, 1 g protein, 8 mg calcium

Chocolate Crinkles

Nutrition Facts per Cookie (using ½ cup confectioners sugar, unsifted): 86 calories, 4 g fat, 67 mg sodium, 13 g carbohydrate, less than 1 g fiber, 1 g protein, 10 mg calcium

Quick-Mix Yellow Cake

Nutrition Facts per Serving: 181 calories, 6 g fat, 264 mg sodium, 29 g carbohydrate, less than 1 g fiber, 3 g protein, 41 mg calcium



RECIPE INDEX



	Page		Page
■ Snacks		■ Main Dishes	
Breakfast Sundae	39	Better-than-Canned Chili	50
Cereal-Marshmallow Bars	34	Egg Salad Filling	48
Chewy Granola Bars	35	French Toast	49
Fruit and Cheese Kabobs	37	Make Your Own Meat Sauce	52
Fruity Shake	37	Pasta with Meat Sauce	53
Make Your Own Cocoa Mix	33	Sloppy Joes	51
Mexican Layered Dip	38	■ Quick Breads	
Pocket Sandwiches	38	Carol's Oatmeal Muffins	54
Quick Veggie Pizza	35	Coffeecake with Topping	59
Shake It Up Pudding	36	Cornbread	56
Zoo Snacks	39	Drop Biscuits	58
■ Side Dishes		Make Your Own Pancakes	60
Baked Potatoes	47	Pancakes From a Mix	61
Carrot-Raisin Salad	45	■ Desserts	
Deviled Eggs	46	Baked Apples	62
Easy Fresh Salsa	47	Brownies	67
Easy-to-Fix Green Beans	45	Cherry Jumble	63
Fruity Fruit Salad	42	Chocolate Crinkles	71
Magical Fruit Salad	41	Easy-to-Fix Cream Pie with Crumb Crust	65
Make Your Own Salad Bar	43	Fruit Crisp	64
Scalloped Corn	44	Jackpot Drop Cookies	70
The Best Applesauce	40	Oatmeal Drop Cookies	68
		Peanut Butter Cookies	69
		Peanut Butter Kisses	66
		Quick-Mix Yellow Cake	73



EQUIPMENT BASICS

Apple corer — a utensil used to remove the apple core when you want to cook and serve the apple whole.

Baking dish — a glass pan used for baking food in the oven. A 1 1/2-quart baking dish holds 6 cups of food. If you do not have a 1 1/2-quart baking dish you can use either a 9x9 baking pan or 10-inch pie plate.

Baking pan — a square or rectangular, straight-side metal pan used for baking. The usual sizes are 8- or 9-inch square and 9"x13" rectangular.

Can opener — a tool designed to remove the lids and tops of cans and jars.

Colander — a utensil used to drain liquid from foods (such as pasta or vegetables). Colanders look like a large bowl with holes to allow water to drain out the bottom and the sides.

Cookie sheet — a rectangular pan that can also be referred to as a baking sheet. They are completely flat or have a shallow rim on one edge.

Cutting board — a wood or plastic board used for cutting up foods.

Electric mixer — a hand-held or stand tool used to beat egg whites, whip cream, cream butter mixtures, and smooth lumps from batter.

Flour sifter — a utensil with a fine-mesh screen that separates flour lumps and gives flour a smooth texture.

Grater — a sturdy, handheld tool with holes for grating or shredding foods.

Griddle — a flat pan often of cast iron, used for cooking pancakes, omelets or steaks on top of the stove.

Hot pad — a pad used under a hot dish to protect a table or to protect the hands when handling a hot dish or pan.

Measuring cups — utensils used to accurately measure dry and liquid ingredients. Available in graduated sizes, dry-measuring cups have flat bottoms and edges. Liquid measuring cups have both cup and fluid ounce markings on the side and a lip and handle for easy pouring.



Measuring spoons — spoons that range from 1/4 teaspoon to 1 tablespoon in size and used to measure small amounts.

Mixing bowl — a round dish that is open on the top and often used with an electric mixer.

Mixing spoon — a utensil used to mix food.

Muffin pan — a baking pan with 6 or 12 cup-shaped holes; muffin pans come in mini, standard and giant size.

Paring knife — a short, very sharp knife used for small tasks such as slicing strawberries and removing eyes from potatoes.

Pastry blender — a kitchen tool made of several parallel bands of wire used for cutting butter or shortening into flour.

Potato masher — a utensil used to crush cooked food. It is often used to mash potatoes and other cooked vegetables.

Saucepan — a round, deep cooking vessel with a handle. A heavy saucepan is desirable to help prevent food from easily burning and sticking when cooking.

Scraper — a utensil with a rubber end used to remove food from the sides of bowls, pots and other equipment.

Skillet — a long-handled, round pan with sloping sides. Also called a frying pan.

Spatula — a flat spoon made of plastic or rubber that is used to mix ingredients or for smoothing a surface.

Strainer — a fine-mesh basket used for separating solids from liquid.

Turner — a utensil designed to turn or lift food. It may be metal or plastic.

Vegetable brush — a utensil designed to clean vegetables and remove dirt from the outer skin.

Vegetable peeler — a utensil used to peel away the outer skin of vegetables.

Whisk — a kitchen utensil with thin wire loops attached to a handle, used for whipping foods together.

Wire rack — used for cooling baked goods. A wire rack allows food to cool quicker and prevents moisture build-up on the bottom of baked goods.



GLOSSARY

- Bake** — to cook with hot, dry air in an oven.
- Beat** — to mix quickly by lifting the food over and over using a spoon, fork, whisk, or mixer.
- Blend** — to mix ingredients until smooth, often with a blender or food processor.
- Boil** — to heat liquid until bubbles break on the surface.
- Chill** — to refrigerate until cold.
- Chop** — to cut into pieces with a knife, chopper, food processor, or blender.
- Drizzle** — to pour gently from a spoon.
- Grate** — to cut food into small pieces by rubbing it against a grater or food processor.
- Ingredients** — food items in a recipe.
- Melt** — to heat until a solid, such as butter or chocolate, becomes liquid.
- Peel** — to remove the outer skin from vegetables or fruits with a knife or vegetable peeler.
- Preheat** — to heat an oven to a certain temperature before baking, usually about 10 minutes.
- Prepared pan** — a dish or pan that is lightly coated with cooking spray or butter, margarine, oil, or shortening so that food does not stick.
- Shred** — to cut into very thin, long, narrow strips.
- Simmer** — to cook in a liquid that is almost boiling but not bubbling.
- Steam** — to cook over or in a small amount of water so that food is cooked by steam.
- Stir** — to mix food round and round using a spoon or fork.
- Toss** — to mix together lightly.



4-H Pledge

I Pledge
my **Head** to clearer thinking,
my **Heart** to greater loyalty,
my **Hands** to larger service,
and my **Health** to better living,
for my club, my community,
my country, and my world.



ISBN 978-1-936582-59-4
9 0000 >



9 781936 582594