

# Private Pesticide Applicator Manual

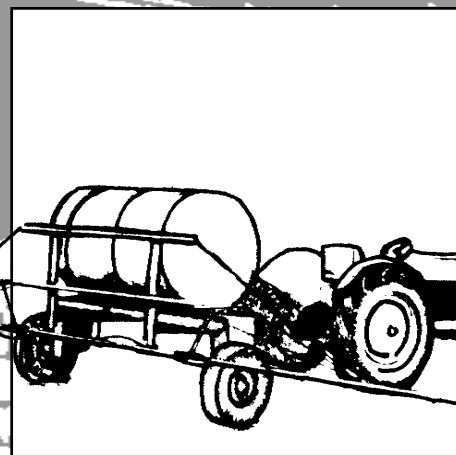
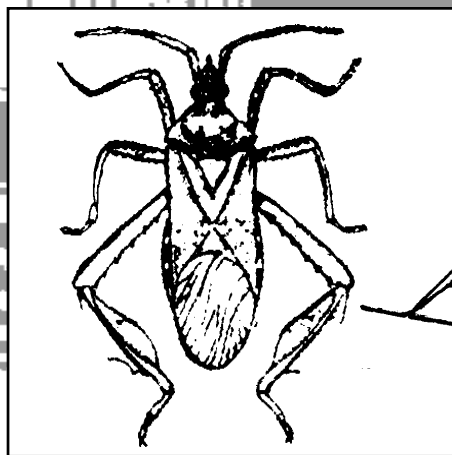
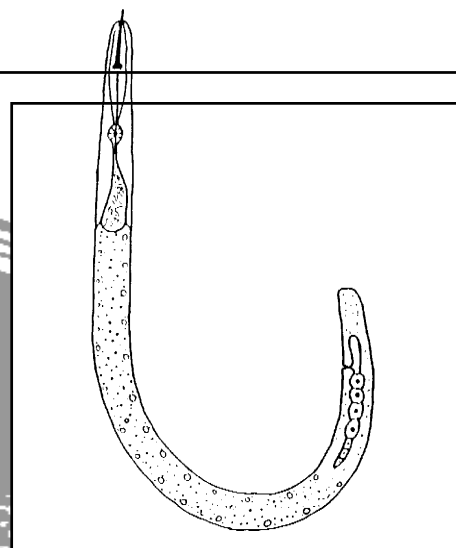

---

# Table of Contents

---

---

---

---



## **Certification Process** 3

- Introduction
- How to Become Certified

## **Pests of Agricultural Plants** 5

- Common Plant Feeding Insect Plants
- Common Weeds
- Common Plant Diseases
- Common Vertebrate Pests

## **Pests of Agricultural Animals** 21

- Cattle
- Sheep and Goats
- Swine
- Horses, Mules, and Donkeys
- Poultry

## **Pest Control** 25

- Principles of Pest Control
- Integrated Pest Management (IPM)
- Pest Control Methods
- Putting It All Together
- Summary

## **Pesticides** 30

- Nature of Pesticides
- How Pesticides Work
- Factors Affecting Pesticide Activity
- Plant Growth Regulators, Desiccants,  
Defoliants and Antitranspirants
- Types of Formulations
- Using the Correct Formulation

## **Labels and Labeling** 39

- Pesticide Registration in Kansas
- Parts of the Label
- Safe Use Precautions
- Pesticide Label Examples

## **Protecting Your Body and the Environment** 56

- Using Pesticides Safely
- Protecting Humans
- Toxicity and Hazard
- Symptoms of Pesticide Poisoning
- Fumigation
- Pesticide Accidents
- Treatment of Poisoning
- Cleanup of Pesticide Spills

---

## Table of Contents

---

Protecting Animals  
Protecting the Environment  
Chemigation  
Potential Benefits  
Pesticide and Bees

---

### **Application Equipment 78**

Sprayers  
Nozzles  
Dusters and Granular Applicators  
Controlling Drift

### **Calibration 86**

Sprayers  
Granular Applicator Calibration  
Volume and Area Determinations

### **Laws and Regulations 94**

Federal Insecticide, Fungicide, and  
Rodenticide Act (FIFRA) as Amended  
Kansas Pesticide Law  
Laws and Regulations in Regard to Wildlife  
Damage Control

### **Terms Used in Pest Control 98**

## Introduction

Federal Regulations set minimum standards for persons handling “restricted use” pesticides. This manual contains the practical information to prepare you to meet these requirements. It does not include all the things you need to know about the pests you wish to control. It does include information to meet the certification requirements for the state of Kansas. This book will tell you:

- how to become a certified private applicator in Kansas,
- some features of common pests, how they develop, and the kinds of damage they do,
- some pests of animals and livestock in Kansas,
- methods you can use to control pests,
- how pesticides work,
- how pesticide labels can help you, and some examples of labels,
- how to use pesticides so they will not harm you or the environment,
- pesticide exposure,
- pesticide toxicity and pesticide hazard,
- cholinesterase tests,
- symptoms of pesticide poisoning,
- pesticide accidents,
- toxicity of pesticides to bees,
- application equipment and calibration, and
- laws and regulations.

## How to Become Certified or Renew Certification as a Private Applicator

Under the Kansas Pesticide Law, private certification would authorize you to use or supervise the use of a restricted use pesticide only to produce an agricultural commodity (1) on property owned or rented by you or your employer, or (2) on the property of another for *no compensa-*

**Under Kansas and Federal laws, it is unlawful for any person to use pesticides in a manner that is inconsistent with such pesticide’s label or labeling.**

*tion* other than trading of personal services between producers; or, for controlling ornamental shrubbery or turf pests at your own residence. **Private applicator certification does not authorize you to apply pesticides on someone else’s property and charge a fee for the service. If you wish to apply pesticides commercially, you must first obtain commercial applicator certification and a business license. Contact the Kansas Department of Agriculture (785-296-3786) for details.**

As a private applicator you must complete the application procedure prescribed by the Kansas State Department of Agriculture, pass an examination, and pay fees. Under the Kansas Pesticide Law, the Private Applicator certification period is five years and expires on the applicator’s birth date of the fifth year.

## Requirements for Initial Certification

Private Applicator **initial** certification and **reentry** (initial certification has expired) are accomplished by passing an open book exam (75% score) over this manual, paying the fees and submitting the application form. The examination is taken in the County Agent’s office.

## Requirements for Renewal Certification

Private applicators can renew certification by passing an open book examination (75% score). Prior to your birth date on the fifth year of your certification period, the Kansas State Department of Agriculture (KDA) will mail you the appropriate Private Applicator Training Manual and

---

## Certification

---

### Process

---

---

---

---

renewal examination. Certification may be renewed for a succeeding five-year period by:

1. Paying the fee as prescribed by the Kansas State Department of Agriculture,

2. Passing the examination, and
3. Submitting the application for renewal. **All requirements must be met prior to the expiration date or else you must follow the procedure for reentry.**

# Pests of Agricultural Plants

The first step in solving any problem is to understand what is causing it. So the first step in your job is to recognize the pests you need to control.

We favor certain plants and animals that provide us food and fiber. But we also provide good growing conditions for other plants and animals that harm them. These living things that compete with us for food and fiber, or attack us directly, are *pests*. The living plant or animal a pest depends on for survival is called the *host*.

Pests can be put into five main groups:

- insects (plus mites, ticks, and spiders),
- snails and slugs,
- vertebrates,
- weeds, and
- plant disease agents.

Most applicators know most of the pests they see on the job. But sometimes unfamiliar pests may appear. You can get identification aids, publications, and pictures to help find out what they are, but the best thing to do is to contact local experts. Ask the Cooperative Extension Service or a competent consultant to help you.

## Common Plant Feeding Pests

Insects thrive in more environments than any other group of animals. They live not only on the earth's surface but within the soil and in water. They eat the choicest foods of man's table. They can even eat the table.

Many types of insects affect crops. They cause damage in a variety of ways. They may:

- feed on leaves,
- tunnel or bore in stems, stalks, and branches,
- feed on and tunnel in roots,
- feed on and in seeds and nuts,
- suck the sap from leaves, stems, roots, fruits, and flowers, and
- carry plant disease agents.

The plants are damaged, weakened, or killed. This causes reduced yields, lowered quality and plants or plant products that cannot be sold. Even after harvest, insects continue their damage in the stored or processed products. Insects also feed on and in man and other animals. Some of these pests carry disease agents which have caused millions of deaths to man and livestock.

Not all insects are pests. Some help man by doing such things as pollinating plants or feeding on other insects that are pests.

## Insect Features

All adult insects have two things in common—six jointed legs and three body regions. But how do you tell one insect from another? Often, the most important parts to look at are *wings* and *mouthparts*. Some insects have no wings. Others have two or four. The wings vary in shape, size, thickness, and structure. Insects with chewing mouthparts have toothed jaws that bite and tear the food. Insects with piercing-sucking mouthparts have a long beak which they force into a plant or animal to suck out fluids or blood.

Almost all insects change in shape, form, and size during their lives. This change is called metamorphosis.

Some insects change only in size as they develop. The adult lays eggs. A nymph, which looks like a tiny adult, hatches from the egg and goes through several stages. These nymphs change into wingless adults.

Some insects change form slightly. Their nymphs hatch from eggs. These nymphs, which have no wings, go through several growing stages. They change into winged adults.

Other insects change completely. They go through four stages. The *larva* hatches from an *egg*. It is a worm, caterpillar, grub, or maggot. This is the stage in which these insects grow and do the most damage. When full-grown, the larva changes into a *pupa*. During this stage it changes into the *adult*. The adult stage usually has wings.

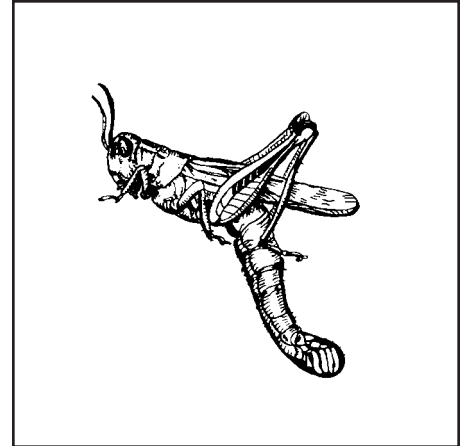

Grasshopper

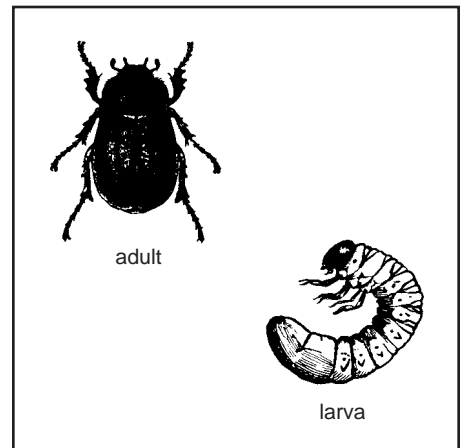

May Beetle

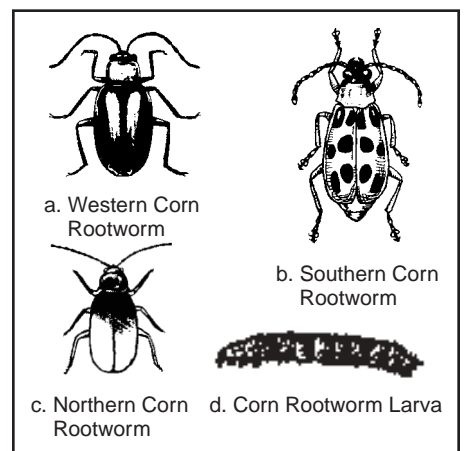

Rootworms

## Pests of

## Agricultural

## Plants

Here are the insect groups that include most of the insects which man considers pests. You should be familiar with the characteristics of each group that you control and the type of damage each group does.

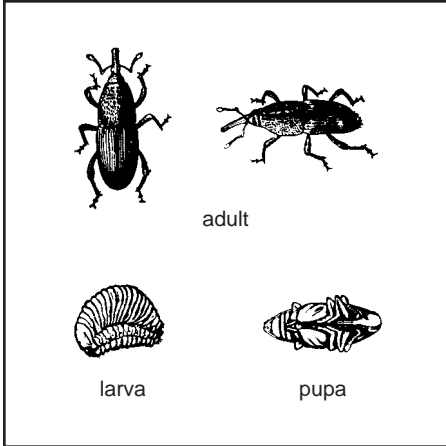

Granary Weevil

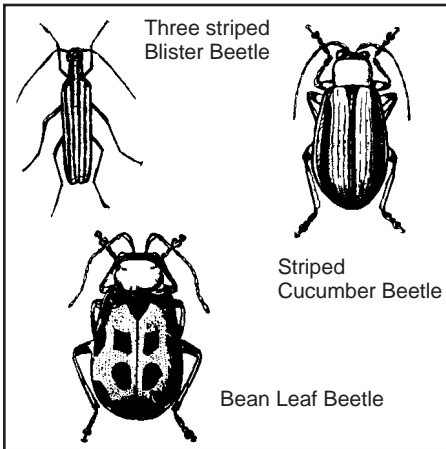

Beetle

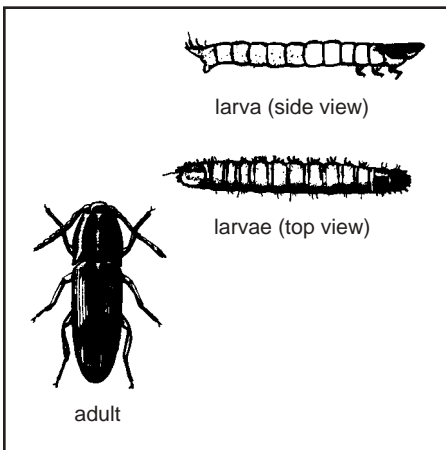

Wireworm or Click Beetle

### Insects with Chewing Mouthparts

#### Grasshoppers and Crickets

These insects have chewing mouthparts. Most are plant feeding and cause damage by chewing holes in foliage. All have a gradual life cycle; that is, adults lay eggs that hatch into nymphs and gradually grow into the adult stage as they feed.

Eggs begin to hatch in mid-May and continue until July. Nymphs resemble the adults but are smaller and wingless. They feed on the same things and cause the same kind of damage as adults.

Adults generally have two pairs of wings. The top wings are narrow, straight, and leathery; the bottom ones broad, pale, and membranous.

Damage occurs from June to September. Nymphs begin feeding around field margins close to hatching areas and gradually migrate farther into adjacent fields.

Control of grasshoppers is more successful where treatments can be directed against the small nymphs still confined to the hatching areas. Rangeland problems are often caused by a different complex of grasshopper species. Egg laying is usually throughout the range area and this requires treatment of the entire range.

#### Beetles

There are chewing insects in the larval as well as the adult stage. In one group of beetles, the head has been prolonged forward and formed into a long, beak-like structure or snout and they are known as "weevils."

Beetles develop in a complete life cycle. The stages consist of eggs, larvae, pupae and adults. Sometimes, one kind of injury is caused by the

larva and yet another kind is associated with the adult. The larvae are totally different in appearance from adults. A typical beetle larva has a distinct head capsule, more or less elongated body, and the majority have three pairs of legs located on the first three segments behind the head. There are no legs on the abdominal segments of beetle larvae. The larvae of the weevils and a few others are often called "grubs." Larvae of weevils are short, robust, legless grubs.

Most adult beetles have four wings—the front pair, thickened and leathery, serve as protective covers for the second; the top pair of wing covers meets and forms a straight line down the center of the back. This characteristic is useful in separating beetles from other groups of insects.

Some examples of common plant pest beetles in Kansas include: white grubs, northern, western and southern corn rootworms, granary weevil, blister beetles, bean leaf beetle, wireworms and alfalfa weevil.

#### Moths and Caterpillars

This is the second largest group or order of insects and represents one of the most destructive groups. We recognize the adults as moths. The moths are the more or less drab colored "millers" that are seen around lights at night.

As adults (moths), these insects are non-damaging, but they do select suitable plants for egg laying. Eggs soon hatch into worm-like larvae or caterpillars. The larvae migrate over plant surfaces and feed for several days.

All of the cutworms belong to this group. They usually live in the soil and migrate from plant to plant, feeding on either above or below ground portions of suitable plants. Some species damage trees and shrubs by feeding on the foliage or tunneling in the stems.

Cutworm larvae usually complete their feeding in a matter of days, although others require longer. The larvae of most species are between 1 and 2 inches in length at maturity.



**Pests of  
Agricultural  
Plants**

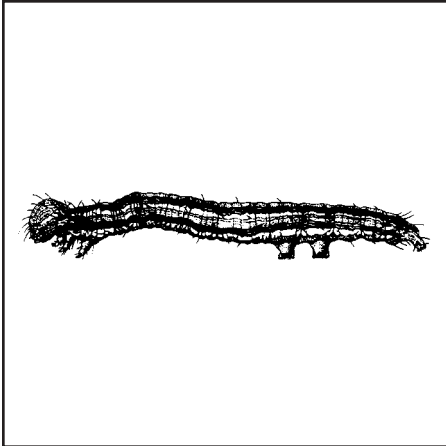

Forage Looper

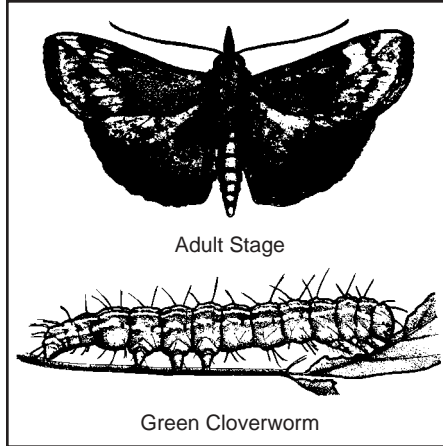

Green Cloverworm

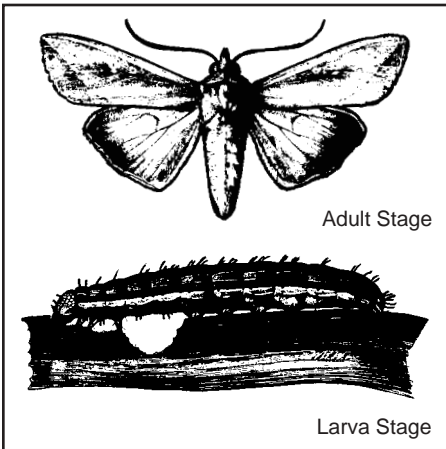

True Armyworm

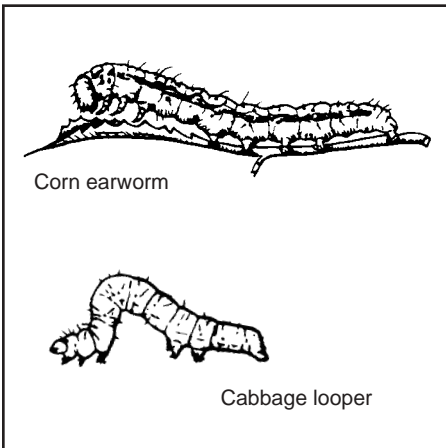

Corn Earworm, Cabbage Looper

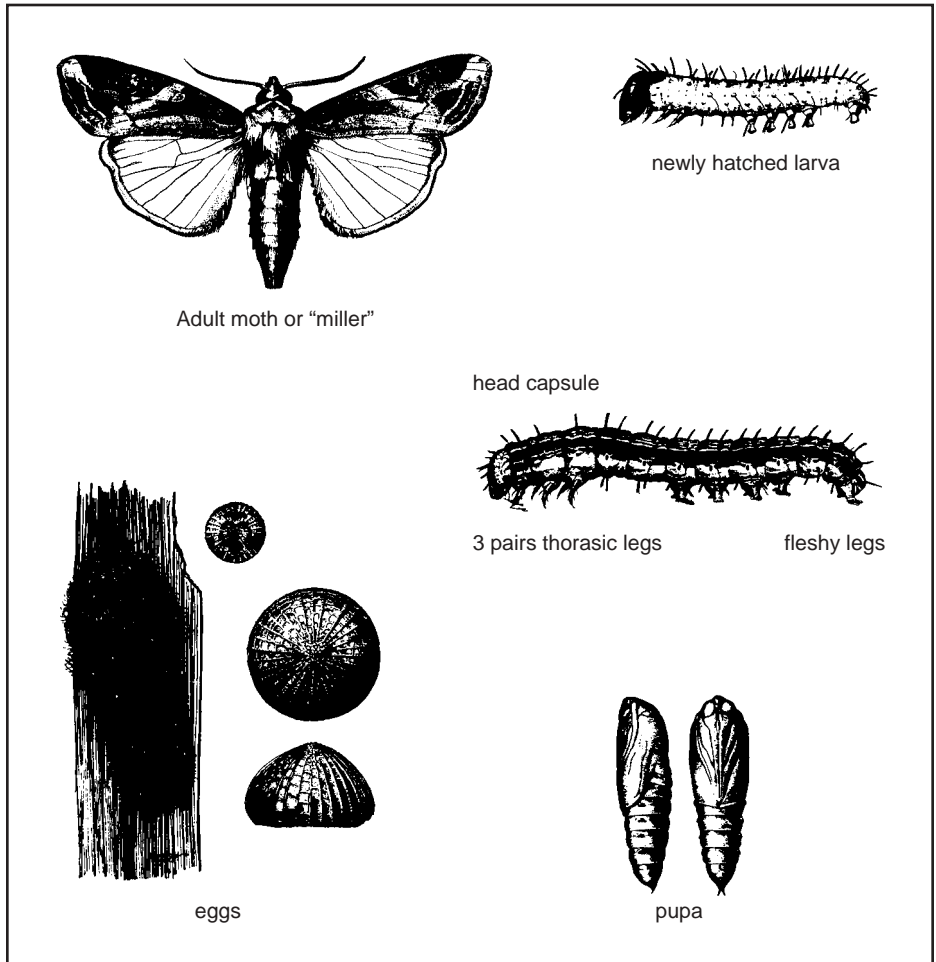

Fall Armyworm



## Pests of

## Agricultural Plants

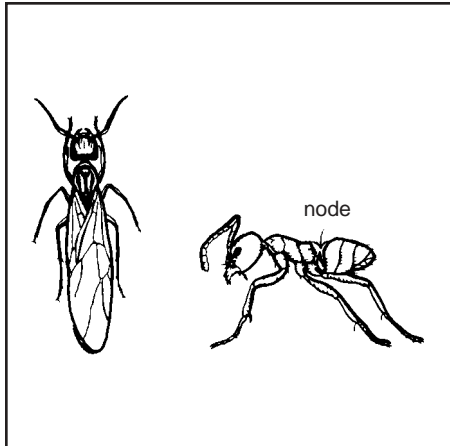

Ants

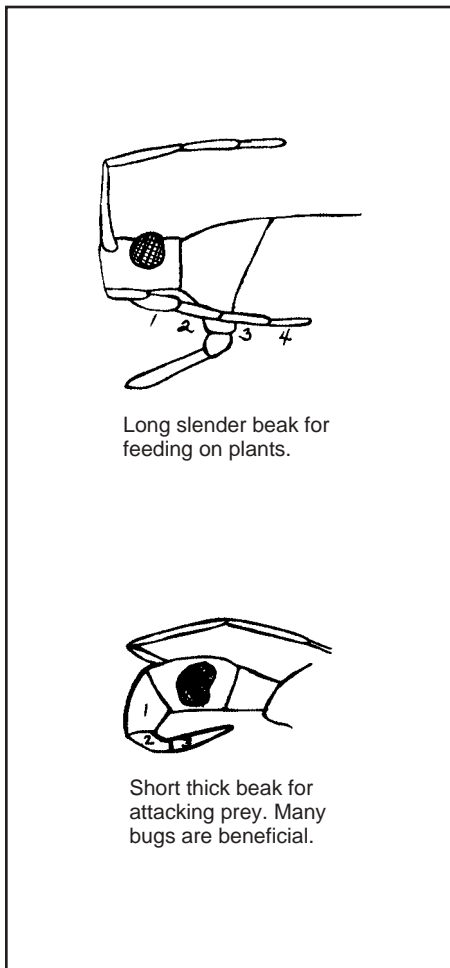

Long slender beak for feeding on plants.

Short thick beak for attacking prey. Many bugs are beneficial.

Mouthparts of Bugs

On a few kinds (woolly bears) the body is covered with a dense coat of hair. On others, the body is covered with spines, but the majority of the damaging species that we commonly see have smooth bodies that are relatively free of hair or spines.

One of the most helpful identifying techniques is to examine the legs. Start on the first segment behind the head. You should see three pairs of slender legs. Looking midway back along the body, you will usually see an additional series of fleshy legs, usually four pairs. Finally, you should find a final pair of fleshy legs attached to the rear of the body.

A complete generation consists of egg, larva, pupa, and adult. The time required to complete the life cycle is usually about 4 to 5 weeks. Examples of destructive insects in this group are cutworms, armyworms, corn borers, corn earworms, forage looper, cabbage looper, and green cloverworm.

### Ants

All members in this group are thread-waisted due to a restriction in the thorax and the abdomen. Use of this characteristic alone is of great help in identification of orders. Wings are membranous, and the front wings are noticeably longer than the hind wings. Some are wingless as adults. The mouthparts of insects in this group are of the chewing type.

These insects have a complete type of life cycle. The immature stages are grub-like or maggot-like, and as such, recognition of the adults gives few clues to the appearance of the larvae.

The social insects belong in this group. They live in colonies and have perfected elaborate social organizations. The social instincts are particularly noticeable among the ants. They build large, complex, multi-story homes with special rooms for nurseries and food storage, and elaborate passageways connecting one chamber to another.

## Insects with Piercing-Sucking Mouthparts

### True Bugs

This is a large group of insects quite similar in appearance and the only insects properly referred to as bugs. Most tend to be rather shield shaped, but usually have bodies that are noticeably longer than wide. Most of the bugs have two pairs of wings.

The basal half of each top wing (where they attach to the body) is hard and leathery, but the remainder is thin and transparent. At rest, the wings lay flat against the top of the body and the transparent portions are overlapped.

The mouthparts are formed into a long, narrow beak which they use to suck out the sap. Since they are sucking insects, early damage is not always obvious as being insect caused. Thus, signs of infestation can be easily confused with disease symptoms.

The bugs have a gradual life cycle—that is, females deposit eggs that hatch into nymphs and nymphs gradually develop into adults. Nymphs resemble the adults except they are smaller and wingless. They cause the same kind of injury and attack the same plants as the adults.

Some examples of destructive true bugs are: squash bugs, stink bugs, leaf-footed bug, plant bugs and chinch bugs.

### Aphids and Leafhoppers

This is another large group of sucking insects. They are closely-related to the true bugs, and similar to them in general appearance, development of their life cycle, and the way they feed. Most members are winged in the adult stage. Wings are entirely thin and membranous. They tend to fold their wings roof-like over their bodies when at rest.

**Cicadas** are among the largest insects of this group. Many of the smaller species, often no more than  $\frac{1}{16}$  inch in length, resemble cicadas

**Pests of  
Agricultural  
Plants**

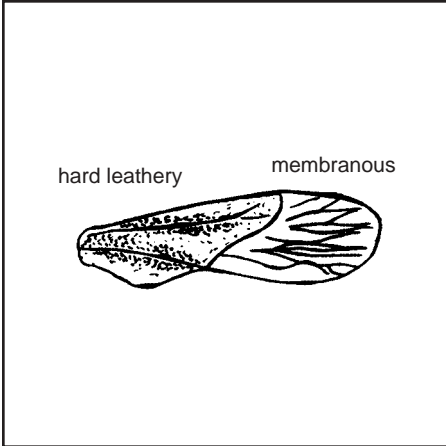

Typical wing

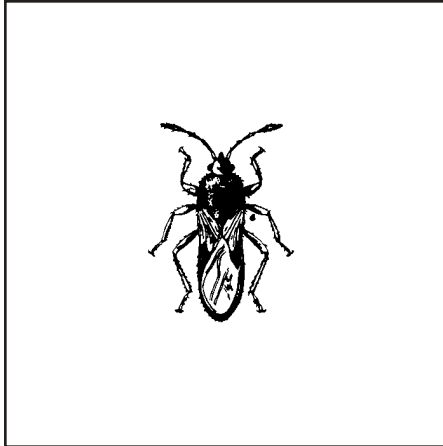

Chinch Bug

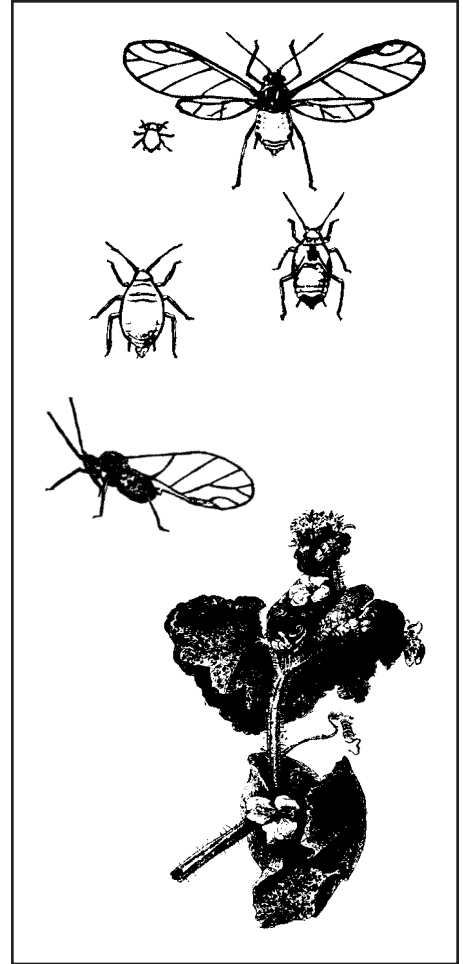

Melon Aphid

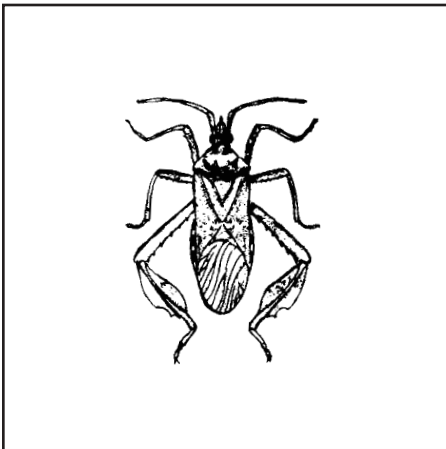

Leaf-footed Bug

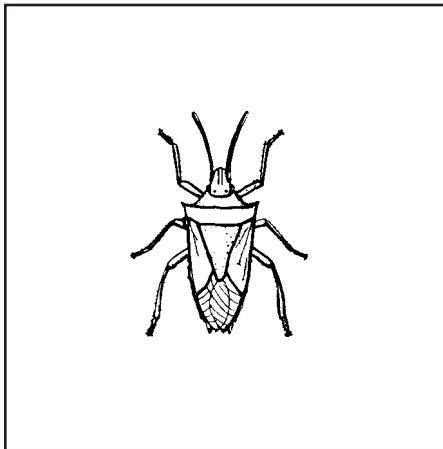

Stink Bug

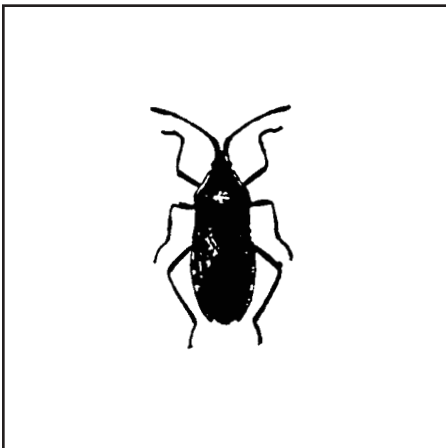

Squash Bug

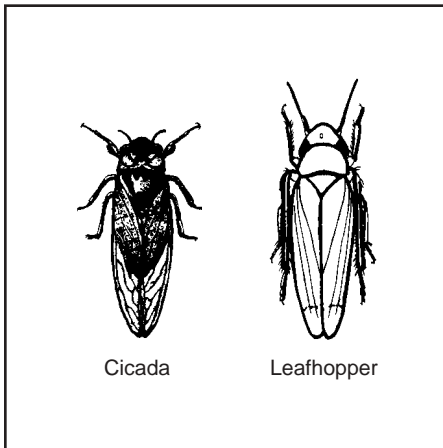

Cicada

Leafhopper

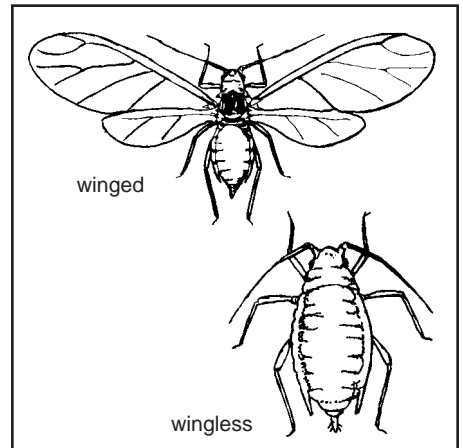

Greenbug

## Pests of

## Agricultural Plants

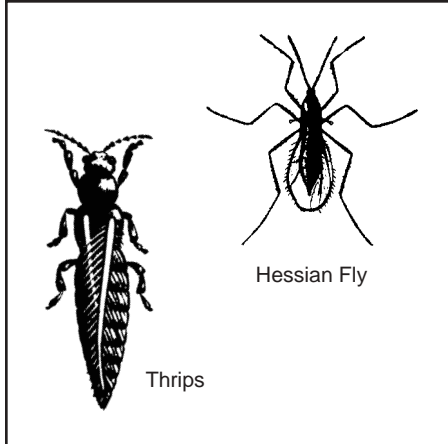

Flies and Thrips

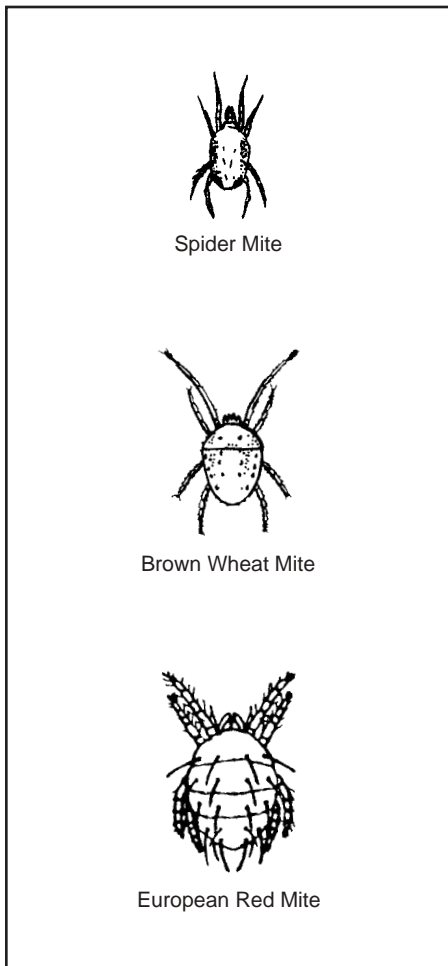

Mites

in overall appearance. Many are no larger than a pin head when they are fully grown.

**Leafhoppers** are small, wedge-shaped insects which suck plant sap from the undersides of the plant leaves. They are usually light green colored and run sideways when the leaf is turned over.

The alfalfa leafhopper causes alfalfa and bean leaves to turn yellow to yellowish-brown, a condition known as "hopper burn." Other leafhoppers transmit various plant diseases.

Examples of leafhoppers are alfalfa leafhopper, bean leafhopper and six spotted leafhopper.

**Aphids** (plant lice) make up a large proportion of this group. Aphids are tiny, soft-bodied sucking insects, winged or wingless, frequently found on the undersides of plant leaves. They suck large quantities of plant sap. Some are damaging, yet others show very little effect on crop yield.

Aphids reproduce very rapidly. A large number of generations is possible during a single season. Hundreds of species of aphids occur in Kansas. Almost every kind of plant is subject to attack by one or more kinds.

Some examples of aphids commonly present in Kansas include: greenbug, corn leaf aphids, green peach aphid, pea aphid, spotted alfalfa aphid and the Russian wheat aphid.

### Insects with Sponging or Rasping Mouthparts

#### Flies and Thrips

True flies have only one pair of wings. The hind wings have been reduced in size and function for balance. The larvae of flies are usually whitish, lack a distinct head, are legless and called maggots.

The seed corn maggot, Hessian fly, and wheat stem maggot are recognized as plant pests in Kansas.

Thrips are very tiny insects, common on many different kinds of plants. As adults they are generally

about  $\frac{1}{8}$  inch in length, and resemble tiny "splinters" as you see them crawling over plant surfaces (their bodies are noticeably longer than wide).

Thrips feed in a peculiar fashion by rasping the surface of the plant tissue and then sucking up the liquids that flow from the injury.

The adults are usually tan to dark bodied with four feather-like wings, while the immature forms (nymphs) are smaller, wingless and usually creamy white.

Both nymphs and adults cause injury by feeding on buds, flowers, or leaf tissues. The feeding causes distortion in flowers and buds and gray or silvery speckled areas on leaves.

Thrips can usually be found early in the spring feeding in the whorls or on the undersides of leaves of seedling sorghum and corn. The presence of a few is considered common and not serious, although damage may occur under some situations when large numbers of thrips are present.

#### Mites

The members of this group are not insects. The adults have eight legs instead of six and they only have two major body regions rather than three.

Mites are of major importance among plant damaging pests. Mites are very small, about the size of the period at the end of this line. Adults have eight legs and most of the time a few spots of color are visible in a mite's body. Mites are soft-bodied, wingless and cause injury by sucking plant juices.

Mites feed primarily on the underside of plant leaves. The area of a mite infested leaf takes on a speckled appearance consisting of tiny yellow spots surrounded by normal green tissue. As feeding continues and the mite population increases, affected foliage will gradually change into more of a uniform yellowish or reddish color, becoming brown as the leaf begins to die. As they feed, mites make thin webs usually on the underside of the leaves.

---

## Pests of Agricultural Plants

---

Mites are generally thought of as dry weather pests. They do not usually develop as rapidly during wet weather and heavy rains. Mites can develop a damaging population in a very short time. Populations are highly regulated by temperature.

Wheat in Kansas is subject to attack by a rather large mite called the brown wheat mite. It is common during dry years in the western part of the state.

In recent years corn, and to some extent sorghum, production has been plagued in the irrigated areas by mite infestations.

### Common Weeds

A weed can be defined as "a plant out of place," or "a plant growing where it's not wanted." Weeds are a problem because they reduce crop yields, increase costs of production, and reduce quality of crop and livestock products. Some weeds cause skin irritation and allergies, while other weeds can be poisonous to man and other animals. Weeds also can be unsightly in turf and ornamental landscapes, as well as create traffic hazards by obstructing the view at intersections.

Plants can be separated into two groups based on plant morphology. Grasses generally have long, narrow leaves with parallel venation, while broadleaf plants tend to have wider leaves of various shapes with a net-like venation. Plant susceptibility to different herbicides depends on the specific plant species.

A complete understanding of weed life cycles, reproduction, and spread is necessary to implement an effective control program. Weeds can be classified as annuals, biennials, and perennials based on their life cycle.

### Annuals

Plants that grow from germinated seed, mature, and produce seed for the next generation in one year or less, are referred to as annuals.

Annuals are the most abundant type of weeds in conventional cropland and frequently disturbed sites, but generally are easier to kill than biennial or perennial weeds. The optimum time to control annual weeds is when they are in the seedling stage of growth and rapidly growing. After annual weeds have flowered, they have nearly completed their life cycle, so control at that time is of little economic value.

*Summer annual weeds* germinate in the spring, grow, mature, produce seed, and die before winter. Summer annual weeds are prolific seed producers and are most common in summer annual crops such as corn, milo, and soybeans. Examples of summer annual weeds include large crabgrass, foxtails, pigweeds, lambsquarters, cocklebur, and common sunflower.

*Winter annual weeds* germinate in late summer or fall, overwinter, mature and produce seed by late spring or early summer, and then die. Winter annual weeds are most prevalent in winter annual crops such as wheat. Examples of winter annual weeds include downy brome, cheat, henbit, field pennycress, and various mustard species.

### Biennials

Plants with a 2-year life cycle are biennials. Biennial weeds germinate and develop a deep taproot and a compact cluster of leaves called a rosette, in the first year of their life cycle. In the second year of a biennial life cycle, the stem elongates (called bolting), the plant flowers, produces seeds, and dies. Biennial weeds are most susceptible to herbicides when they are in the rosette stage of growth and before they have bolted. Biennial weeds are most common in pastures and noncropland sites. Examples of biennial weeds include common mullein, common burdock, and musk thistle.

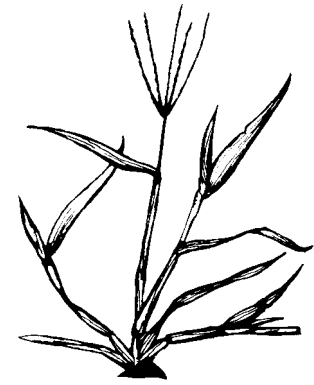

Large Crabgrass—  
a summer annual



Downy Brome—  
a winter annual

### Annuals

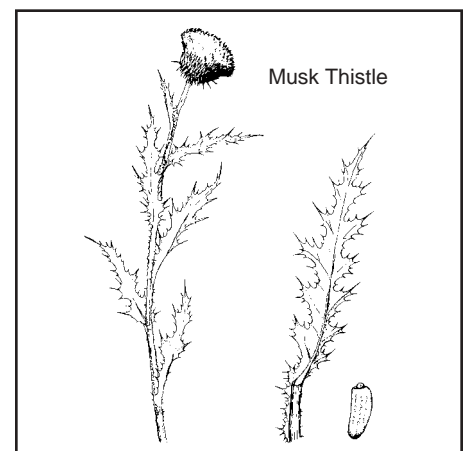

### Biennials



## Pests of

## Agricultural

## Plants

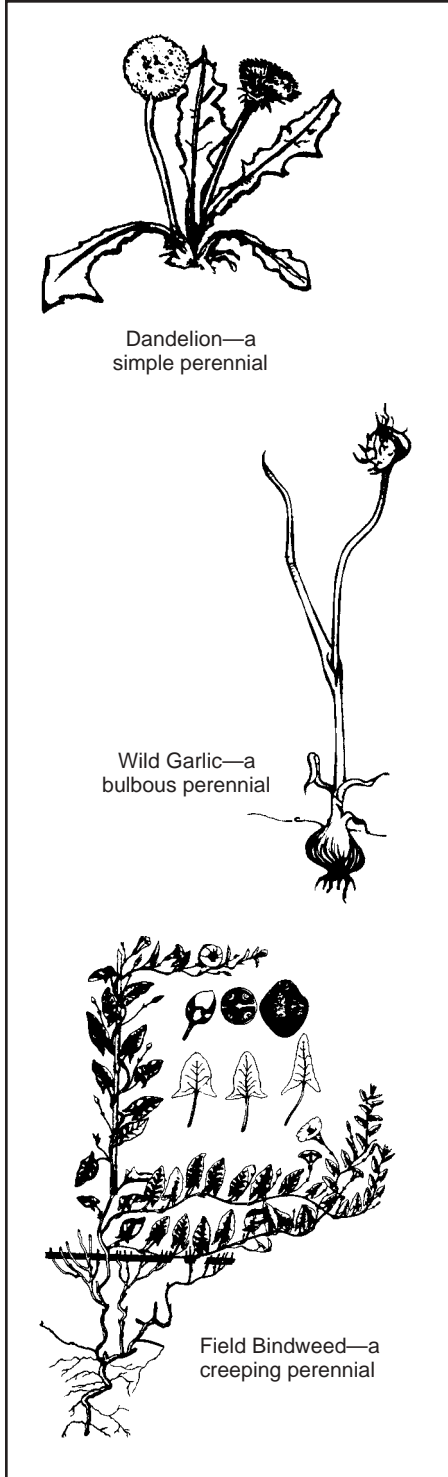

Dandelion—a simple perennial

Wild Garlic—a bulbous perennial

Field Bindweed—a creeping perennial

Perennials

### Perennials

Plants that live 2 or more years are perennials. Perennial plants generally go dormant during the winter months and produce new foliage during the spring and summer from stored food reserves in the stems or under-ground plant parts. Perennials can be spread by seed, but also can reproduce vegetatively from tubers, bulbs, rhizomes (below ground stems), stolons (above ground stems that produce roots), and root stem segments.

*Simple perennials* reproduce primarily by seed. However, new plants can develop from root pieces that result from mechanical injury such as tillage or hoeing. Examples of simple perennial weeds include common dandelion, curly dock, and many trees and bushes.

*Creeping perennials* produce seed, but also spread vegetatively once they become established in an area. Vegetative spread occurs with rhizomes, stolons, and spreading root systems. Examples of creeping perennials include bermudagrass, quackgrass, Johnsongrass, field bindweed, and common milkweed.

*Bulbous perennials* may reproduce by seed, bulblets, or bulbs. Examples of bulbous perennial weeds include wild onion and garlic, which produce seed and bulblets above ground and bulbs below ground.

Perennials generally are the most difficult type of weeds to kill. Since most perennials can reproduce vegetatively and regrow from under-ground plant parts, destroying the top growth only provides temporary control until the shoot regrows. Thus, systemic herbicides such as 2,4-D, dicamba (Banvel), picloram (Tordon), or glyphosate (Roundup or Kleenup) that will translocate to the under-ground plant parts are most effective for long-term perennial weed control.

### Noxious Weeds in Kansas

The Kansas Noxious Weed Law enacted by the Kansas Legislature has declared several weeds as noxious

weeds in Kansas, which according to the law must be controlled. Kansas noxious weeds include:

- Kudzu
- Russian knapweed
- Canada thistle
- Leafy spurge
- Field bindweed
- Hoary cress
- Pignut
- Johnsongrass
- Quackgrass
- Woollyleaf bursage (Bur ragweed)
- Musk thistle
- Multiflora rose (county option)
- Sericea lespedeza (county option)

### Common Plant Diseases

A plant disease is any harmful condition that makes a plant different from a normal plant in its appearance or function. Plant diseases are divided into two groups based on their cause.

#### Non-parasitic Plant Diseases

These are caused by non-living agents, such as nutrient deficiency, extreme cold or heat, toxic chemicals (e.g., air pollutants, some pesticides, salts, too much fertilizer), mechanical injury, and lack or excess of water. Non-parasitic diseases cannot be passed from one plant to another.

#### Parasitic Plant Diseases

These are caused by living agents which live and feed on or in host plants. They can be passed from one plant to another. The most common causes of parasitic diseases are *fungi*, *bacteria*, *viruses*, and *nematodes*.

Three things are required before a parasitic disease can develop:

1. a susceptible host plant,
2. a parasite, and
3. an environment favorable for parasite development.

*Fungi* are usually composed of multi-celled thread-like filaments called hyphae. Most are microscopic, but some, such as the mushrooms, may become quite large. Most

reproduce by spores, which function about the same way seeds do. Not all fungi are harmful, and many are helpful to man.

Fungi may attack a plant both above and below the soil surface. Fungus diseases include apple scab, smut in corn, powdery mildew in landscape plants, rose black spot, rust of wheat, and root and stalk rots of many crops.

**Bacteria** are single-celled organisms which are much smaller than fungi. They usually reproduce by simply dividing in half. Each half becomes a fully developed bacterium. Bacteria can build up fast under ideal conditions. Some can divide every 30 minutes. Fireblight of pears, halo blight of beans, and bacterial leaf spot on peaches are caused by bacteria.

**Viruses** are much smaller than bacteria and are composed of protein and genetic material. They come in a variety of shapes and sizes, but they can only be seen with a high-powered electron microscope. Viruses are often identified by their symptoms on host plants.

Many viruses that cause plant disease are carried by insects, usually aphids or leafhoppers. Some viruses are transmitted when machines or people touch healthy plants after touching diseased plants. Many viruses are easily carried along in bulbs, roots, cuttings, and seeds. A few are transmitted in pollen. At least one virus, wheat soilborne mosaic virus, is transmitted by a fungus.

Wheat streak mosaic, maize dwarf mosaic of corn and sorghum, and tomato spotted wilt are diseases caused by viruses.

**Nematodes** are small, usually microscopic, round-worms. Many nematodes are harmless, but some feed on or in plant roots. Nematodes usually do not kill plants, but reduce growth and plant health. They may weaken the plant and make it susceptible to other disease agents.

All nematodes that are parasites on plants have a hollow feeding spear. They use it to puncture plant cells

and feed on the cell contents. Nematodes may develop and feed either inside or outside of a plant.

The life cycle of nematodes includes an egg, four larval stages, and an adult. Most larvae look like adults, but are smaller. Many nematodes migrate from root to root. The females of some, such as root knot and cyst nematodes, become fixed in the plant tissue. The root knot nematode deposits its eggs in a mass outside of its body. The cyst nematode keeps part of its eggs inside its body after death. They may survive there for many years.

### Development of Plant Diseases

Development of a parasitic disease depends on the life cycle of the parasite. Some parasites (e.g., smuts) have one cycle per year. Others (e.g., wheat rust) have many cycles per year. The environment affects this cycle greatly. Temperature and moisture are especially important.

The disease process starts when the parasite arrives at a part of a plant where infection can occur. This step is called **inoculation**. If environmental conditions are good, the parasite will begin to develop. This stage before injury develops is called **incubation**. If the parasite can get into the plant, the stage called **infection** starts.

The three main ways a plant responds are

1. over-development of tissue such as galls, swellings, and leaf curls,
2. under development of tissue, such as stunting, lack of chlorophyll, and incomplete development of organs, and
3. death of tissue, such as blights, leaf spots, wilting, and cankers.

### Identifying Plant Diseases

Disease identification depends on **symptoms** (leaf spots, mosaic, galls, etc.) and **signs** of the causal agent (visual evidence of fungal hyphae, nematode cysts, etc.). Other evidence such as disease field pattern, timing

## Pests of Agricultural Plants

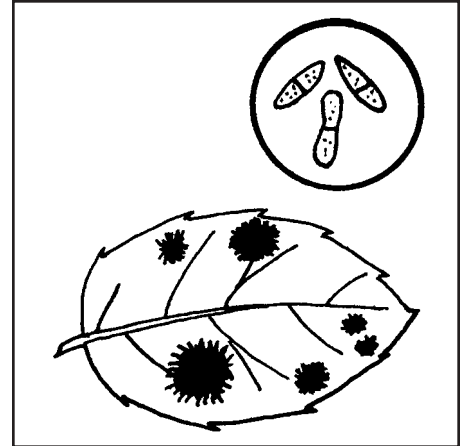

Rose Black spot symptoms and magnified fungus spores

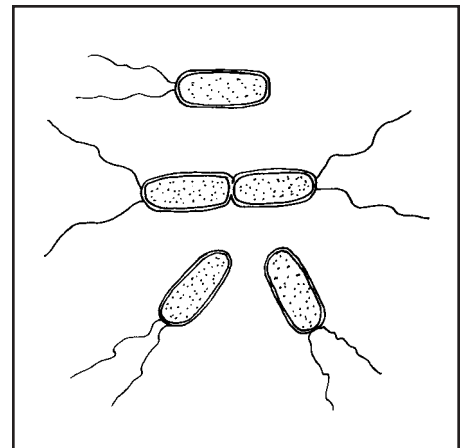

Bacteria reproducing

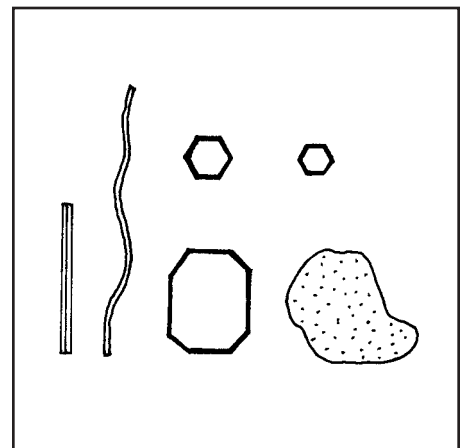

Different kinds of viruses

## Pests of

### Agricultural

### Plants

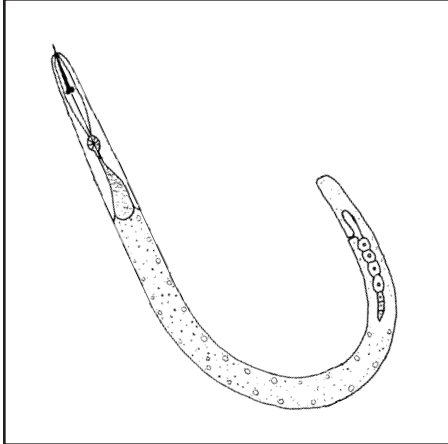

Nematode with feeding spear extended

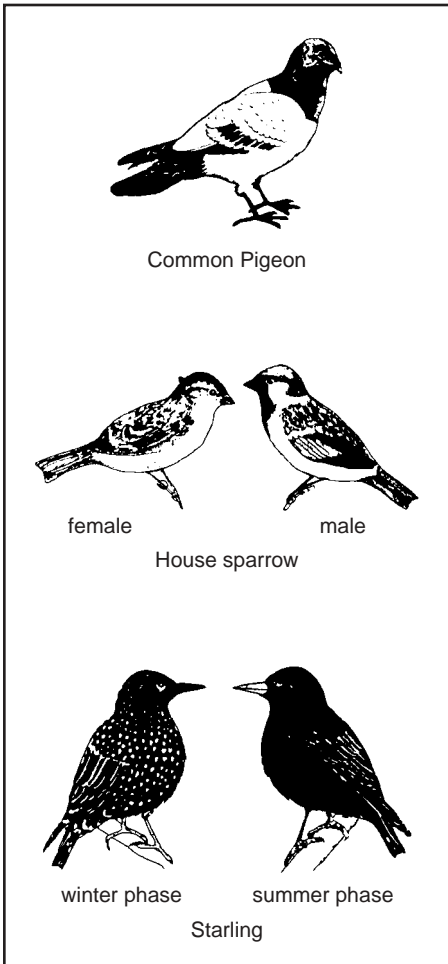

Birds

of symptoms, and preceding weather are often needed.

Many plant disease fact sheets, often with color photographs, are available from your local county Extension office. Your Extension office can also help you submit specimens to the Plant Disease Diagnostic Laboratory.

#### Controlling Plant Diseases

Plant disease control is usually achieved through some combination of the following methods: crop rotation, resistant varieties, sanitation of infested crop debris, eradication of diseased plants, use of disease-free planting stock, use of cultural practices which suppress disease development, or protection with pesticides.

#### Common Vertebrate Pests

Many forms of vertebrate wild animals are involved in damage to crops, livestock, rangeland and other agricultural property. Animals that are a pest in some situations may be highly desirable in others. Therefore, wildlife damage control (also called animal damage control) is often controversial. These matters should be approached with caution and with a great deal of knowledge about the options and laws relating to damage control procedures. Modern approaches to resolving problems of this kind are aimed at *controlling* the damage, *not* the population of the species involved. At times, local population control may be desirable but *never* widespread population control. These higher forms of animals have tremendous compensation factors and to accomplish complete eradication of a species in a given area is thought to be impossible.

Much of the damage involving vertebrate animals can be avoided by using preventive management strategies and/or integrated damage control methods.

Generally, common agricultural pests in the vertebrate animal world are classified as either bird, rodent, or predator. In a few cases, other

animals such as snakes, deer, bats, moles, etc., may be involved in damage to agriculture in Kansas.

#### Animal Damage Control in Kansas

Today, as at the beginning of this century, animal damage control (ADC) is an important component of agricultural production. In dealing with this issue, Kansas producers receive assistance from Kansas State University, Cooperative Extension Service (KSU-CES), Kansas Department of Wildlife and Parks (KDWP), and United States Department of Agriculture, Animal Damage Control (USDA-ADC). The KDWP enacts regulations aimed at resolving ADC problems. All three major agencies, KSU, Kansas Department of Wildlife and Parks, and the USDA-ADC work together to alleviate wild animal damage in Kansas.

Before doing any wild animal damage control, you should check with the KDWP. Also, for any species of problem animal, information for control procedures is available from Kansas State University, Wildlife Damage Control, Manhattan, KS (phone: 785-532-5734).

#### Birds

Some of our most costly bird damage problems involve non-native birds such as starlings, pigeons, and house sparrows. All of these birds are generally closely associated with people. Not all bird problems are caused by introduced species. Blackbirds, grackles, cowbirds, and crows are often involved in damage situations.

Feedlots are damaged when birds consume feed, contaminate feed and water, and may spread diseases. Studies have shown that starlings may eat one pound of feed per month directly from livestock feed bunks.

Starlings have been implicated in the spread of transmissible gastroenteritis (TGE) of pigs.

Blackbirds, grackles, crows, starlings and house sparrows damage growing crops of milo, sunflowers,



---

## Pests of Agricultural Plants

---

---

and corn in Kansas. In some smaller fields near marshes or wooded areas damage can be excessive.

Pigeons, sparrows, and starlings may damage farm and ranch machinery and other property by leaving bird droppings at roosts. These droppings may ruin paint finishes and create a bad smell, leave parasites and might cause human and livestock health problems.

### Cultural Bird Damage Control at Livestock Feedlots

Some livestock feeding management practices can be changed to reduce bird depredations. The simplest means of reducing feed losses to problem birds is to make the feed less available for their consumption. Feed can be made less available to starlings by physical separations of feed from starlings by the use of feeds that are either less palatable or that cannot be physiologically used by starlings. Before changing any feeding management practices, consult your livestock nutritionist.

The best, although the costliest, method of preventing starling depredations is to feed livestock in an enclosed bird-proof area. Feeding livestock in bird-proofed buildings has shown to be beneficial not only in reducing feed losses to starlings but also in improving animal performance. Enclosure by conventional means (i.e., doors, windows, or screens) may result in an undesirable restriction of animal movements. To alleviate this, some researchers enclosed farm buildings and feeding areas with industrial polyvinyl chloride plastic (PVC) strips. These strips are similar to those used to minimize air flow through cold food sections of some grocery stores.

If grain products must be fed outdoors, several management practices are available that can reduce feed losses to starlings. Feeds can be offered in self feeders or automatic feeders with lids that are diligently maintained to prevent flip tops from being bent, dislodged, or lost. Self

feeders should be concentrated at a few sites to limit the sources for potential depredation.

Since starlings forage only during the daylight hours, feeding livestock in the late afternoon or early evening will limit the amount of time feed is exposed to starlings. However, cattle fed at night have shown slower weight gain. Therefore, livestock producers may wish to limit this option to periods when high numbers of birds are present.

Starlings consumed  $\frac{3}{16}$  inch diameter pellets at a much higher rate than granular meal. The granular meal, does, however, attract starlings to the feed site and daily consumption of this meal could be economically significant. Consumption by starlings of  $\frac{1}{2}$  inch diameter pellets was significantly less than consumption of the granular meal. Based on these findings, grain products should be fed as large pellets or cubes ( $= \frac{1}{2}$  inch diameter), liquids, or less desirable, granular meal.

Nutritionists must have accurate data on cost benefit ratios before they encourage feedlot operators to switch feeding practices and feed forms.

### Field Rodents

Animals like prairie dogs, pocket gophers, pack rats, norway rats, house mice, cottonrats, and prairie voles sometimes damage stored crops, feed, livestock, buildings, rangeland and growing crops in Kansas.

Again, two of the worst offenders are non-native animals; the norway rat and the house mouse. Norway rats and house mice generally live in close association with people and are usually found around buildings and not out in the wild.

Native rodents such as 13-lined ground squirrels, cottonrats, prairie voles, deer mice and white-footed mice often eat planted seeds. Pack rats or wood rats sometimes build their nest in agriculture-related buildings and these rodents also eat the insulation off wires of automobiles,

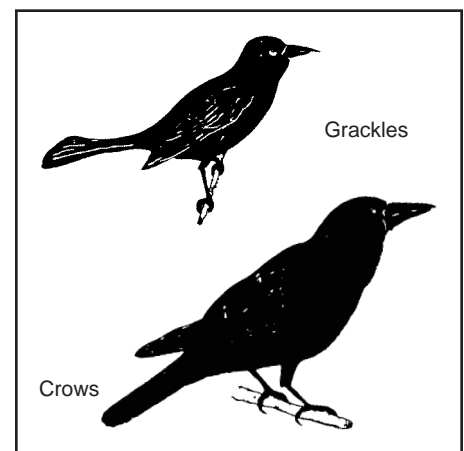

Birds

## Pests of

### Agricultural

### Plants

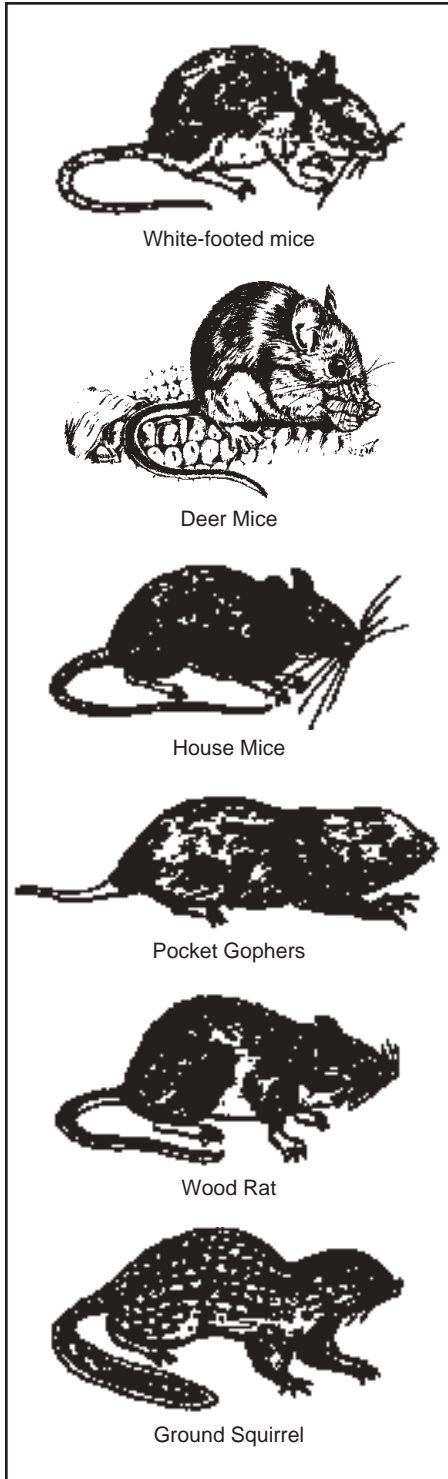

Rodents

trucks, and farm machinery. Larger rodents, such as beaver, dig burrows into stream and pond banks which sometimes cave in and create hazards to cattle or farm machinery. Muskrats dig burrows into earthen dikes that hold water, and at times, these dikes break as a result of muskrat burrowing activity.

#### Hantavirus Infection

The recently recognized hantavirus-associated disease among residents of the southwestern United States and the identification of rodent reservoirs for the virus in the affected areas warrant recommendations to minimize the risk of exposure to rodents for both residents and visitors. The Centers for Disease Control and Prevention has given the hantavirus a new name: Muerto Canyon Hantavirus.

Rodents are the primary reservoir hosts of recognized hantaviruses. Each hantavirus appears to have preferential rodent hosts, but other small mammals can be infected as well. Available data strongly suggest that the deer mouse is the primary reservoir of the newly recognized hantavirus in the southwestern United States. Serologic evidence of infection has also been found in pinon mice, brush mice, and western chipmunks. The deer mouse is highly adaptable and is found in many different habitats, including human residences in rural and semi-rural areas.

Human infection may occur when infective saliva or excreta are inhaled as aerosol produced directly from the animal. Transmission may also occur when dried materials contaminated by rodent excreta are disturbed, directly introduced into broken skin, introduced onto the conjunctive, or, possibly, ingested in contaminated food or water. Persons have also become infected after being bitten by rodents.

Known hantavirus infections of humans occur primarily in adults and are associated with domestic, occupational, or leisure activities that bring

humans into contact with infected rodents, usually in a rural setting. Patterns of seasonal occurrence differ, depending on the virus, species of rodent host, and pattern of human behavior. Cases have been epidemiologically associated with the following situations:

- planting or harvesting field crops;
- occupying previously vacant cabins or other dwellings;
- cleaning barns and other outbuildings;
- inhabiting dwellings with indoor rodent populations;

The reservoir hosts of the hantavirus in the southwestern United States also act as hosts for the bacterium agent of plague. Although fleas and other ectoparasites are not known to play a role in hantavirus epidemiology, rodent fleas transmit plague. Control of rodents without concurrent control of fleas may increase the risk of human plague as the rodent fleas seek an alternative food source.

Eradicating the reservoir hosts of hantaviruses is neither feasible nor desirable. Currently, the best available approach for disease control and prevention is risk reduction through environmental hygiene practices that deter rodents from colonizing the home and work environment.

Rodent infestation can be determined by direct observation of animals or inferred from the presence of feces in closets or cabinets or on floors or from evidence that rodents have been gnawing at food. If rodent infestation is detected inside the home or outbuildings, rodent abatement measures should be completed.

Areas with evidence of rodent activity (e.g., dead rodents, rodent excreta) should be thoroughly cleaned to reduce the likelihood of exposure to hantavirus-infected materials. Clean-up procedures must be performed in a manner that limits the potential for aerosolization of dirt or dust from all potentially contaminated surfaces and household goods.

Special precautions are indicated in the affected areas for cleaning homes or buildings with heavy rodent infestations. Persons conducting these activities should contact the responsible local, state, or federal public health agency for guidance. These precautions may also apply to vacant dwellings that have attracted numbers of rodents while unoccupied and to dwellings and other structures that have been occupied by persons with confirmed hantavirus infection. Workers who are either hired specifically to perform the clean-up or asked to do so as part of their work activities should receive a thorough orientation from the responsible health agency about hantavirus transmission and should be trained to perform the required activities safely.

Persons who frequently handle or are exposed to rodents (e.g., mammalogists, pest-control workers) in the affected area are probably at higher risk for hantavirus infection than the general public because of their frequency of exposure. Therefore, enhanced precautions are warranted to protect them against hantavirus infection.

There is no evidence to suggest that travel into the affected areas should be restricted. Most usual tourist activities pose little or no risk that travelers will be exposed to rodents or their excreta. However, persons engaged in outdoor activities such as camping or hiking should take precautions to reduce the likelihood of their exposure to potentially infectious materials.

### **Controlling Prairie Dogs with Poison Grain Bait**

Controlling prairie dogs with poison grain bait is most effective during clear settled weather (rain washes the toxicant from some baits) and is only effective when their most desirable food (green grass) has become dried and dormant. Fall baiting is successful because prairie dogs are actively eating grass seeds to build up fat reserves for the winter. Baiting is

restricted to the July through January period and is most successful from September to November.

Prebait with untreated oats (preferably steam-rolled oats) one to two days prior to baiting. Prebaiting is essential because:

1. it will increase the acceptance of treated bait which will result in significantly better control,
2. it gives more predictable results than without prebaiting, and
3. it is required by the label.

Apply both prebait and bait on the edge of each mound where the bare soil and grass interface; do not place on the top of the mound or down the burrow. Watch the weather; apply bait only on clear, sunny days when moisture is not predicted. Bait should be applied during the early morning to allow time for the daytime active prairie dogs to eat the bait; bait applied during the late afternoon is often consumed by other rodents that are primarily active at night.

Livestock should be removed from the pasture when poison grain is being used to control prairie dogs. Livestock can be returned two weeks following bait application or when bait has been eaten by prairie dogs. The bait should be thinly scattered in a 6-inch bait spot; avoid placing the bait in piles which may endanger livestock. Apply treated bait only after all or most of the prebait has been eaten and only to burrows where the untreated bait was consumed, usually two days after prebaiting.

### **Controlling Commensal Rodents**

Common barn rats, or the norway rat, house mice, and occasionally deer mice occur on many farms and ranches in and around farm buildings across Kansas. A good rule of thumb to remember in commensal rodent control is to follow five steps. It is important to follow each step starting with number 1, then 2, and so on. Do not start at number 2 first. Here are the steps:

---

## Pests of

---

### Agricultural

---

### Plants

---

**1. Stress.** Put rodents under as much stress as you can by practicing good sanitation. Remove as much food, water, and hiding places as possible. Then, at maximum stress level, go to step 2.

**2. Single-dose.** Use a single-dose rodenticide so as to obtain a quick knockdown of a rat population. Pre-baiting with unpoisoned bait for several days prior to baiting will increase bait acceptance, indicate rats will eat bait and the amount eaten per day will give you an idea of the amount needed when you bait the area. Use single dose baits only once per year and then for a week or less.

**3. Multiple-dose.** Use multiple-dose rodenticides after knocking population of rats down. Keep baits fresh continuously as long as feeding occurs, usually for at least 2 weeks.

**Bait selection and placement.**

Anticoagulant baits are available in several types. Grain baits in a meal or pelleted form are often available in bulk or packaged in small plastic, cellophane, or paper packets. These "place packs" keep baits fresh and make it easy to place baits into burrows, walls, or other locations. Rodents will readily gnaw into these bags to get into an acceptable bait.

Anticoagulant baits that have been formulated into paraffin blocks are available from various suppliers. These blocks are particularly useful in sewers or where moisture may cause loose grain baits to spoil quickly. Acceptance of paraffin block baits by rodents is usually less than that of loose grain baits.

Sodium salts of anticoagulants to be mixed into a water solution are available. Since norway rats require water daily, they can be drawn to water stations in some situations. Mice may not always require free water. Water baits are particularly effective in grain storage structures, warehouses, and other locations where water is scarce.

Use of bait boxes protects rodenticides from weather and provides a safeguard to people, pets, and other animals. For rats, bait stations should

have at least two openings approximately 2½ inches in diameter and should be large enough to accommodate several rats at a time. Place bait boxes next to the walls, with the openings close to the wall, or in other places where rats are active. Label all bait boxes clearly with the words "Caution—Rodent Bait" or another similar warning.

Where it is impossible to exclude rodents from buildings and around their perimeter, fresh anticoagulant bait will control invading rats before breeding populations become established.

**4. Traps.** Trapping can be an effective method of controlling rats, but requires more skill and labor than most other methods. Trapping is recommended where poisons seem inadvisable, and it is the best method to try first in homes, garages, and other small structures where there may be only a few rodents present. Trapping has several advantages:

1. it does not rely on inherently hazardous rodenticides;
2. it permits the user to view his success; and
3. it allows for disposal of rodent carcasses, thereby eliminating odor problems which may occur when poisoning is done within buildings.

A simple, inexpensive wood-based snap trap is available in most hardware and farm supply stores. Wire cage traps are more expensive but somewhat more successful than snap traps. Bait traps with peanut butter or a small piece of hot dog, bacon, or nutmeat tied securely to the trigger. The trigger should be set lightly so that it will spring easily. Set traps close to walls, behind objects, in dark corners, and in places where rodent activity is seen. Place the traps so that rodents, following their natural course of travel (usually close to a wall), will pass directly over the trigger.

Use enough traps to make the campaign short and decisive. Leaving traps unset until the bait has been taken at least once reduces the chance of rodents becoming trap-shy.



An alternative to traps are glue boards, which catch and hold rodents attempting to cross them in much the same way flypaper catches flies. Place glue boards along walls or in other areas where rodents travel. Do not use them where children, pets, or desirable wildlife can contact them. Glue boards lose their effectiveness in dusty areas unless covered. Extremes in temperature also may affect the tackiness of the adhesive.

**5. Rodent-Proof Construction.** The most successful and permanent form of rodent control is to “build them out” by making their access to structures impossible. Ideally, all places where food is stored or used should be rodent-proof.

Seal any openings larger than  $\frac{1}{4}$  inch to exclude both rats and mice. Openings where utilities enter buildings should be sealed tightly with metal or concrete. Equip floor drains and sewer pipes with tight-fitting grates having openings less than  $\frac{1}{4}$  inch in diameter. Doors, windows, and screens should fit tightly. It may be necessary to cover edges with sheet metal to prevent gnawing.

## Predators

Animals such as coyotes are the most well known form of predator in Kansas. Other mammalian predators which are involved in common agricultural damage problems including the domestic dog, skunks, badgers, raccoon, bobcat, puma, bear and foxes.

While the puma and bear are rare in the state, there is evidence of both being present at times. The damage they might cause would be to livestock, and in the cases involving bears, they destroy bee hives.

Skunks and foxes are most often involved in the transfer of rabies. Domestic dogs, either wild or free-ranging, do considerable damage to livestock and at times threaten people. Badgers, in their search for field rodents, dig large holes in which farm machinery falls and may cause a breakdown. Raccoons raid sweet

corn, watermelon and cantaloupe patches. Raccoons also destroy buildings and eat livestock feed.

Even though a person confronted with a predator problem can see little use for predators, all native wild predators are essential to a healthy environment.

### Some Insights About Predators

By biological definition, a predator is an animal that satisfies some or all of its nutritional requirements by killing and feeding on other animals. A more humanistic definition may state that a predator is anything that competes with man for a particular resource. In the broadest sense, predators include a variety of species from spiders, to rainbow trout, to African lions. Perhaps the most commonly thought of species in this category is the coyote. A close family member of the coyote is the domestic dog which, on a national scale, may even exceed the coyote in terms of the number of sheep operations it negatively impacts. However, most dogs do not fit the traditional definition of a predator in that they do not need to feed on sheep to survive. Their acts of predation are usually carried out as play behavior. On the other hand, truly feral dogs prey on sheep for reasons similar to those of coyotes and other natural predators of livestock.

Other predators of sheep not necessarily ranked in order of importance include bears, mountain lions, foxes, bobcats, eagles, ravens, and hogs. Other raptors and scavenging birds including vultures, crows, magpies, and some gulls may also occasionally kill lambs. Poisonous snakes may also kill sheep, but they are not generally considered predators since their motive for killing livestock is rarely to secure food.

Some predators such as cat species, eat almost exclusively other animals or animal products (e.g., eggs) and rarely scavenge on carrion.

Coyotes often include many items in their diet. In many areas, rabbits top the list of dietary components for

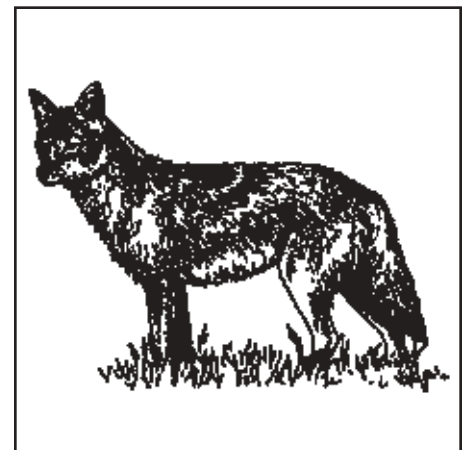

Coyote

---

## Pests of

---

### Agricultural Plants

---

---

coyotes. Carrion, rodents, ungulates (usually fawns), insects (e.g., grasshoppers), and livestock and poultry (when available), are also consumed. Coyotes readily eat fruits such as watermelons, berries, and other vegetative matter when they are available. In some areas, coyotes feed on human refuse at dump sites and take pets (cats and small dogs) in some urban settings.

A trait common to most predators is that they are opportunistic. They generally take prey that is the easiest to secure in terms of a minimization of energy expended and risk of injury. For these reasons, young, inexperienced animals are often victims of predation as are old, sick, or weakened individuals. Many predators are capable of catching and killing healthy, adult prey. Prey is selected based on opportunity and on a myriad of behavioral cues. Strong, healthy lambs are often taken from a flock by a coyote even though smaller, weaker lambs are there also. Usually, the stronger lamb is on the periphery and is more active. Both factors make it more prone to be attacked than a weaker lamb that is at the center of the flock and relatively immobile.

Predation on livestock is generally more severe during summer than in winter. This stems largely from two factors. Sheep are usually under more intensive management during winter, either in feedlots or in pastures that

are close to human activity. There is less opportunity for predators to take livestock under such conditions. The second factor is related to predator biology. Predators bear young in the spring and raise them through the summer. This process demands increased nutritional input, both to the whelping and nursing mother, as well as to growing young. This time corresponds to when young sheep are on pastures or rangeland and are most vulnerable to attack. Predation also may rise during fall when young predators disperse from their home ranges in search of territories to occupy.

Predators are generally secretive animals and avoid contact with humans and human activity. As a result, the act of predation is not usually seen by people. Predation most often occurs from evening to early morning, although it can take place at any time during the day or night.

Predation is a natural phenomenon and occurs on a daily basis within the ecosystem. Sheep have been bred for centuries to be docile, tractable animals, and they do not have the behaviors to survive among predators without help from man. When a sheep is killed by a wild predator, the predator is seizing an opportunity in its game of survival. The objective of a program of predation control is to remove or minimize the opportunity for predators to prey on sheep.



Striped Skunk

# Pests of Agricultural Animals

Agricultural animals are attacked by mites and ticks, insects, and animal predators. These pests affect animal productivity by: killing animals, spreading disease agents and parasitic worms, causing loss of blood, causing physical damage to animals or animal products, reducing weight gains, reducing milk or egg production, and decreasing animal resistance to other diseases.

The biology and habits of each species provide clues to selecting and targeting helpful control measures.

## Cattle

The insects and related pests that attack cattle include the following:

### Horn Fly

This small, bloodsucking fly remains on the animal most of the time. The female lays eggs in fresh cattle droppings. The larvae develop there, and the adult fly then migrates to host animals. The horn fly can complete its life cycle from egg to adult in as little as 10 days.

### Face Fly

The face fly also develops in single fresh cattle droppings. Adult face flies cluster around the eyes and noses of animals. These flies feed on animal secretions, nectar, and dung liquids. Face flies are important factors in the spread of pinkeye among cattle. The life cycle from egg to adult is completed in 2 to 3 weeks in favorable weather.

Control is difficult due to the mobility of the flies and short, effective life of insecticides.

### Heel Fly (Cattle Grub)

These flies produce one generation each year. They lay eggs on hairs of the host animals. The larvae (grubs) enter the skin at the base of the hairs. After migrating to the gullet or spinal

canal, the larvae move to the loin area. Here they cut breathing holes through the hide and produce cysts (warbles). Cattle brought in from other states may be carrying grubs in a different stage of development than those in local cattle, so treatment timing may vary. The fully grown grubs emerge through the breathing holes, drop to the ground, and pupate in the soil. Adults emerge in warm weather.

### House Flies and Stable Flies

House flies can transmit many animal diseases. House flies feed on manure and animal secretions through sponging mouthparts. Large numbers of flies may annoy feeder and dairy cattle, causing reduced efficiency or production and increased bacterial counts in milk.

The stable fly is similar to the house fly but sucks blood through piercing mouthparts which protrude spearlike from under the head of the adult.

Both house and stable flies develop in decaying silage, spilled feeds, animal bedding, manure, moist hay and other forage.

House flies may develop from egg to adult in as little as 8 days; stable flies usually require 3 to 4 weeks.

Sanitation is the key step in control of these flies. Disposal of animal wastes and organic debris is essential. Chemical control and biological control work only when used in conjunction with good sanitation practices.

### Horse Flies and Deer Flies

Horse and deer flies are common biting flies of cattle and horses. There are many species, each of which has a different preference for biting specific parts of the animal's body. The females are strong fliers with painful bites. The bites of horse flies often continue to bleed after the fly leaves.

Immature stages live under the soil, usually in aquatic or semiaquatic places.

Horse flies often spread the disease, anaplasmosis. Control of these flies is difficult because they may

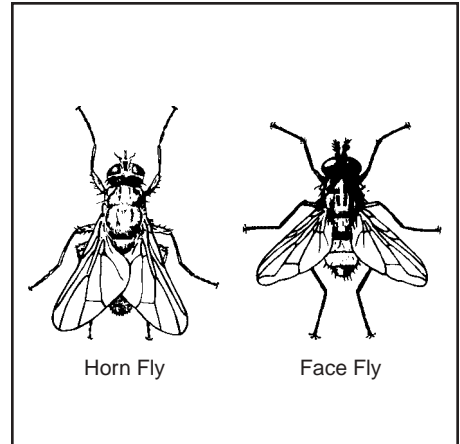

Horn Fly

Face Fly

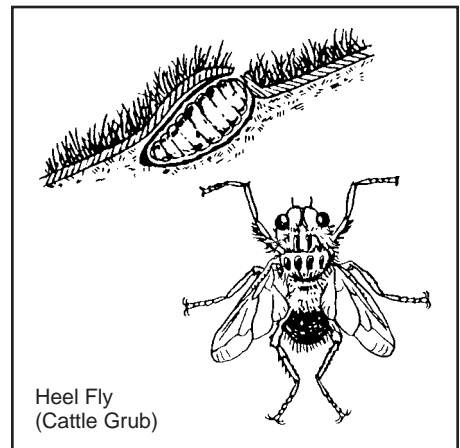

Heel Fly  
(Cattle Grub)

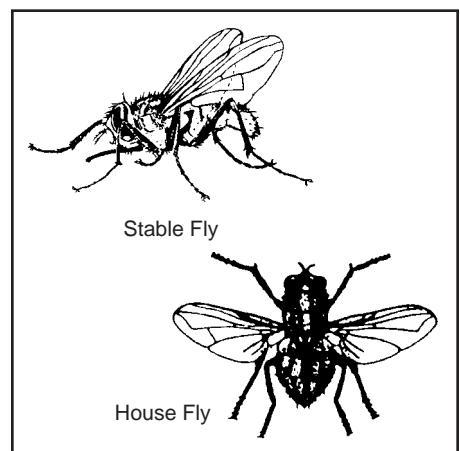

Stable Fly

House Fly



## Pests of

### Agricultural

### Animals

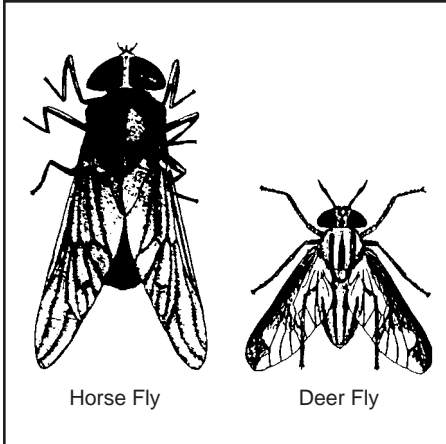

Horse Fly

Deer Fly

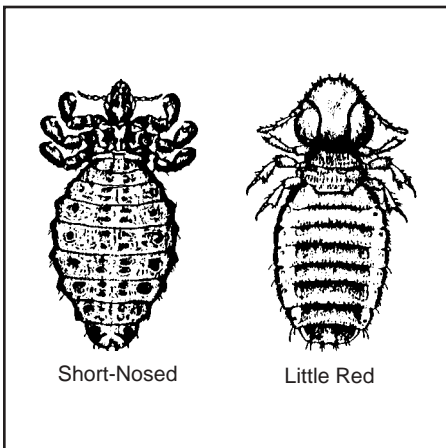

Short-Nosed

Little Red

Cattle Louse

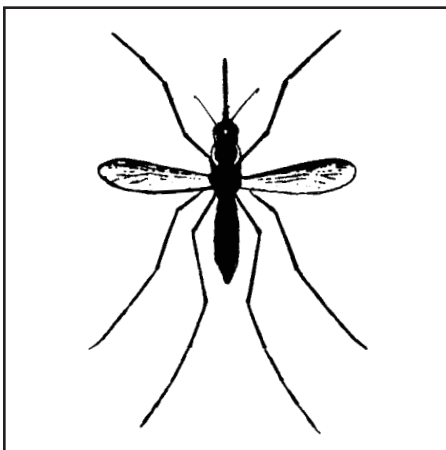

Mosquito

migrate over long distances and do not stay on the host long enough to be killed by residual sprays.

#### Chewing and Sucking Lice

Lice spend their entire life cycle on the animal. They hatch from eggs deposited on the hair. They feed by sucking blood or chewing on the skin. Most louse populations are greatest during cold weather months. Cattle tail lice are more numerous during summer, but occur only on cattle from southern states. Lice are spread chiefly by contact with infested animals.

#### Mosquitoes

Mosquitoes transmit diseases of animals and man and may affect efficiency of animal meat and milk production. Life cycles of mosquitoes vary greatly, depending on the type of mosquito and the environment. The female lays eggs on water or in areas subject to flooding. The larvae and pupae develop in water and the adults emerge from the pupae.

The best control method is to eliminate or minimize standing-water areas, such as potholes, water tanks, unused receptacles, and other man-made containers. Some insecticides control both larvae and adults. Others are classed either as larvicides or adulticides. Health concerns may require treating swamps and seep areas where mosquitoes breed. However, great care should be taken to preserve the ecology of the wetlands.

#### Ticks

Ticks are parasites of domestic and wild animals, and humans. They can transmit diseases. In addition, loss of blood and injection of toxins during tick feeding affect animal health, weight gains, and milk production.

Correct identification of ticks is important for economical and effective control. To control ear-infesting ticks (such as Gulf Coast and spinose ear

ticks), apply pesticides directly to the ear. To control species infesting the body (such as the lone star tick), treat the entire body. Treatment must be repeated for some tick species. Tick control may be required during any season of the year.

#### Cattle Scabies

Scabies is caused by an infestation of a specific mite. These mites tunnel in the skin, causing mange.

Scabies causes skin irritation, excessive hair, skin, and water loss, severe weight loss, and reduced milk production. It also makes the animal more susceptible to other diseases. Transmission is by contact with infested animals or mite-contaminated material.

Treat infested animals by spraying or dipping them in insecticides registered for this purpose or by subcutaneous injection of an appropriately labeled parasiticide. Scabies treatment is regulated by Federal quarantine laws.

#### Sheep and Goats

The insects and related pests that attack sheep and goats include the following:

##### Sheep Ked

Adult sheep keds resemble ticks and are often misnamed as "sheep ticks."

The sheep ked is a wingless fly which spends its entire life cycle on sheep. It is occasionally found on goats.

The nearly mature larvae are deposited on wool strands, where they pupate almost immediately. The adult emerges and begins to feed on blood.

The sheep ked reduces wool yield and lamb growth rate and causes a damaged hide condition called "cockle." Applying insecticides at shearing gives the most efficient control.

---

## Pests of

## Agricultural

## Animals

---

### **Chewing and Sucking Lice**

Sheep and goat lice cause intense skin irritation, resulting in reduced quality and quantity of fleeces, and blood loss, resulting in anemia. Several species are involved.

Infestations are spread by contact with infested animals. Insecticides will provide louse control.

### **Sheep Scabies**

This mite pest is under Federal quarantine regulations and infestations **MUST** be reported. Call a veterinary service.

### **Nose Bot**

Living fly larvae are deposited in or around the nostrils of the sheep. The larvae migrate to head sinuses, where they develop. At maturity, they migrate back down the nasal passages and drop to the ground, where they pupate and become adults. Migration of the larvae irritates the nasal membranes and is often followed by secondary infections. An effective drench treatment is now registered for control of sheep nose bots.

### **Wool Maggot (Black Blow Fly)**

This fly lays eggs in dirty wool or on wounds. After hatching, the fly maggots spread over the animal and feed on skin tissue under the fleece. Their damage sometimes causes death.

Early shearing and medication of wounds before blow fly season is an effective preventive measure. Clipping and cleaning the fleece will help prevent infestations. Insecticides are effective in controlling this pest.

### **Spinose Ear Tick**

This is the only tick which normally poses a problem to sheep. Its feeding on the inner folds of the ear produces much discomfort and results in a breakdown of the ears.

The spinose ear tick can be controlled by applying insecticides to the inner folds of the sheep's ear.

## **Swine**

### **Flies**

Stable flies, house flies, horse flies, and mosquitoes are also pests of swine. Refer to descriptions in the Cattle section.

### **Hog Lice**

The presence of hog lice may be indicated by excessive scratching and rubbing. This causes reddening and thickening of skin and results in reduced weight, particularly in young pigs. Heavy infestations may cause death. The life cycle is the same as that of cattle lice.

### **Mange Mites**

Burrowing mites cause mange. They can be controlled by spraying or dipping or by injection with an appropriately labeled parasiticide.

## **Horses, Mules, and Donkeys**

Insects and related pests that attack these animals include the following:

### **Deer Flies, Stable Flies, House Flies, Face Flies, Horse Flies, and Mosquitoes**

See Cattle section.

### **Lice**

For descriptions, refer to Cattle section. Damage includes loss of hair, scurfiness of skin, and irritability of the animal. Animals may become unmanageable and may injure themselves.

### **Horse Bots**

The three main species—nose, chin (or throat), and common bots—attach their eggs to the hair of the



Tick



Scabies Mite

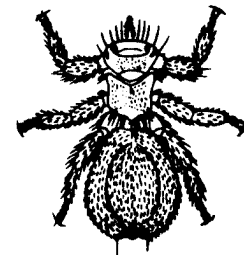

Sheep Ked

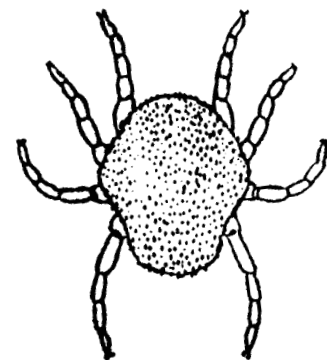

Spinose Ear Tick

## Pests of

### Agricultural

### Animals

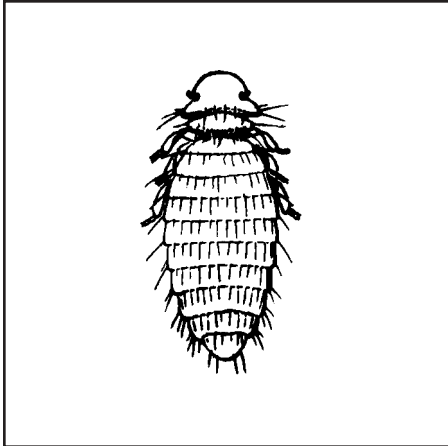

Chicken Louse

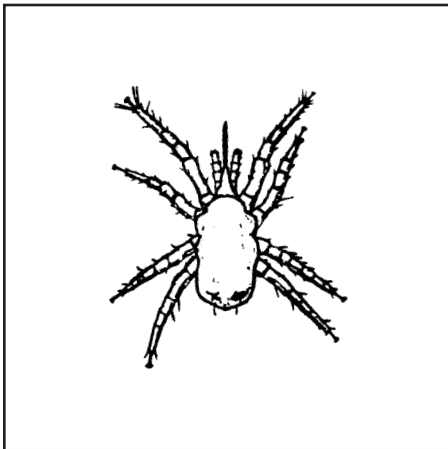

Chicken Mite

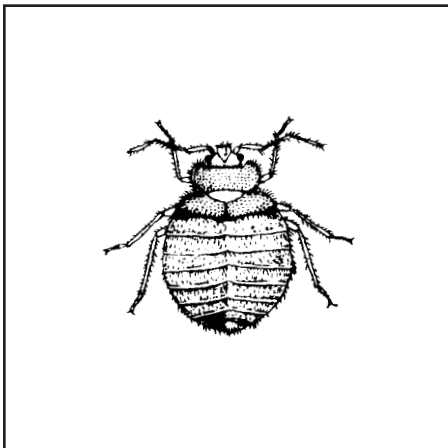

Bed Bug

horse. The eggs hatch and the larvae are transferred to the animal's mouth. They migrate to the stomach, where they remain until full grown.

They are then eliminated with the dung and pupate in the soil, emerging as adult bot flies at various times from early summer to October.

Horse bots usually have one generation each year.

Treatments include orally applied pastes and drenches.

#### Ticks

Equine ticks are the same species that attacks cattle. Refer to tick section under Cattle.

### Poultry

#### Lice

Several species of chewing lice infest poultry. They spend their entire life on the host. Louse transmission is by direct contact with infested birds or with louse infested debris. Lice are more common during cold weather. Infested birds become restless and damage themselves by pecking at body areas. Weight gain and egg production may decrease.

#### Mites

Several species of mites infest poultry. The most common is the chicken or red mite, which feeds on blood during the night and hides in cracks of the house during the day. Another common mite is the northern fowl mite, which spends all of its life on the bird.

Infested birds develop skin irritation and anemia. If not controlled, dense mite populations may reduce weight gains and egg production or cause death.

Mite infestations are transferred from bird to bird. They sometimes are a result of invasion of poultry houses by wild birds. Other means are infested feathers and poultry handling equipment, flats, manure, workers, and poultry feet.

#### Chiggers

Chiggers are a problem on range birds, primarily turkeys. Infested turkeys may be downgraded in quality by lesions caused by chigger bites. Apply pesticides to the ground as sprays or dusts. Repeated applications may be necessary.

#### Fowl Ticks

Although several species of ticks may infest poultry, the most prevalent is the fowl tick. The fowl tick causes about the same kind of damage as poultry mites. All forms (larvae, nymphs, and adults) attach to the skin. They suck blood and cause skin irritation. Loss of blood in chicks can be great enough to cause death. Older birds become anemic, and production is reduced.

These ticks hide in cracks and crevices in poultry houses. Infested birds also transmit ticks to other birds.

#### Bed Bugs

Bed bugs are serious pests in poultryhouses and may become a pest of man. They hide from the light during the day and feed on poultry in the dark. They may survive for long periods without feeding. Infested poultry suffer blood loss, which may result in anemia.

#### Flies

Many types of flies are pests on poultry ranches. The house fly is the most common problem.

Some flies may transmit disease to poultry. Adult flies which disperse into the surrounding environment are a nuisance to man and may transmit human and animal diseases.

Good sanitation is important for successful fly control. Follow the suggestions in the Cattle section for house and stable fly control.

Here are six steps you must follow to solve pest problems:

1. Identify the pest.
2. Know what control methods are available.
3. Evaluate the benefits and risks of each method or combination of methods.
4. Choose the most effective methods that cause the least harm to you and the environment.
5. Know the correct use of the methods, and
6. Know local, state, and federal regulations that apply to the situation.

## Principles of Pest Control

We often talk about the “war” against insects, plant diseases, weeds, and rats. In a war between countries, would a national leader use only the Army? Wouldn’t he also use other tools—Navy, Air Force, and propaganda?

Yet, in our struggle against pests, how often do we just use the handiest or least expensive pesticide? How often do we forget to consider other methods or combinations of methods? How often do we forget about effects on the environment? It may be too often.

The use of a combination of methods to control pests is basic to all pest control. Modern pest control uses all available methods to keep pests below economically harmful levels, and damages the environment as little as possible in the process.

The challenge lies in our ability to control pests so that injury caused by them is held to a minimum, and to recognize when direct action, such as a pesticide application, is necessary.

## Integrated Pest Management (IPM)

Integrated Pest Management (IPM) is the planned manipulation of pest populations in an attempt to achieve

a balance between costs and returns, and between farm production and the overall environment. Integrated Pest management practices include use of: cultivation, changes in cropping sequence, barriers, pest resistant or tolerant varieties, sanitation, traps, beneficial insects, timely planting and harvesting, and judicious use of chemical pesticides. IPM is accomplished by growers who consider all alternative pest control practices that are available on their farms, then use one or more cost-effective pest control practices that are least harmful to the environment.

Use of effective IPM practices must be based on current information about the pest problem such as the numbers and kinds of pests in the specific crop or herd. Inadequate knowledge or improper diagnosis of the pest problem results in wasteful use of time and money and disappointing control of the pest(s).

## Management Tests

IPM must be practical and tailored to each pest problem on your farm.

Three tests of practicality are:

1. Is it available (to *my* farm, *when* I need it)?
2. Does it fit my entire crop or herd management program (or can present management be feasibly changed to accommodate the pest management practice(s) being considered)?
3. Cost effectiveness. The “bottom line” when one’s livelihood is involved must always be: “Will it pay?”

The third factor is the basis of the two concepts *economic injury level* and *economic threshold*. *Economic injury level* is the lowest number of pests that will cause an amount of injury equal to the cost of applied control practices. *Economic threshold*, sometimes called the “action threshold” is the pest number or density at which remedial control practices should be taken to prevent the pests from exceeding the economic injury level. The economic threshold is necessarily lower than the economic injury level to allow time to

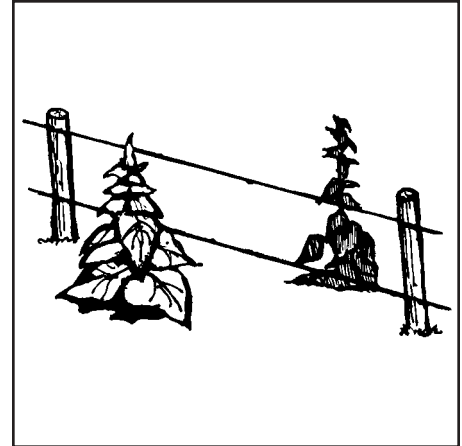

Resistant Varieties

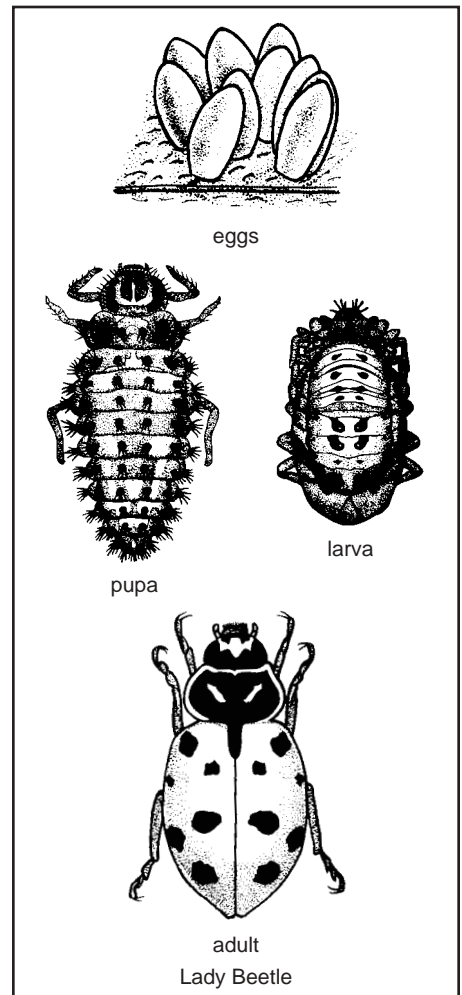

Biological Control



## Pest Control

apply control practices and to permit time for those control practices to control the pests.

*Integrated pest management consists of selection of specific control practices which work well together to best solve a specific set of pest problems under the conditions which prevail at that time and place.*

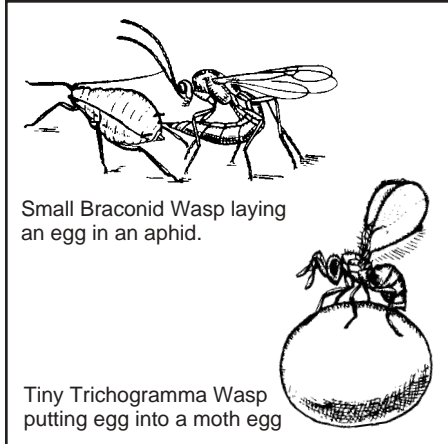

Biological Control

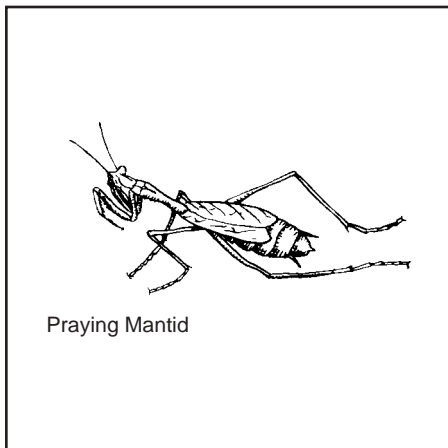

Biological Control

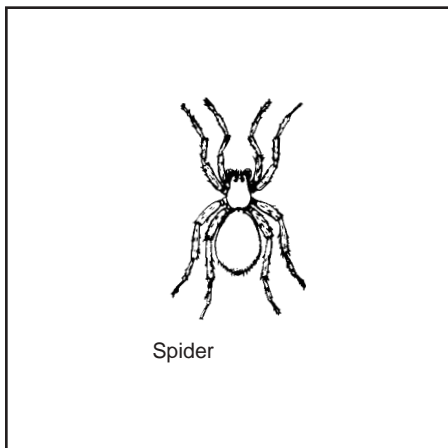

Biological Control

### Pest Control Methods

Many pest control methods have been known and used for years. But some methods, what we call them, and the way we put them together are new. Here are the most important pest control methods.

#### Resistant Varieties

Some crops, animals, and woods resist pests better than others. By using resistant types, we make the environment less favorable for pests.

Varieties that are genetically resistant to injurious insect and disease infestations can produce higher yields than varieties not tolerant to these pests. Kansas farmers are familiar with Newton wheat which is resistant to the disease, soil-borne mosaic; and Larned which is resistant to the insect, Hessian fly.

The Extension fact sheet, "Wheat Variety Disease and Insect Ratings," (MF-991) gives the reaction of wheat varieties to several important wheat diseases and Hessian fly. It is updated regularly to include currently grown varieties.

#### Biological Control

Biological control refers to the use of parasites, predators, and disease organisms to control pests. "Beneficial organisms" are living organisms that destroy pests of man and of crops, and thus are beneficial to us.

Many serious pests are controlled by beneficial organisms. Introduction of beneficial organisms for pest control is seldom cost-effective for a single farm, however. The effectiveness of biological control depends on

a thorough understanding of injurious pests and the beneficial organisms, as well as their interactions with one another in the environment.

Beneficial organisms occur naturally in growing crops. Natural beneficial organisms reduce the damage from our injurious plant and animal pests. Below are a few of the examples of natural biological controls that occur in wheat fields.

Lady beetles help control greenbugs, and tiny parasitic wasps can annihilate established infestations of greenbugs in wheat and grain sorghum. Cutworm populations are reduced by large predatory beetles that roam the fields at night but are seldom seen in the daytime. During years of armyworm infestations, a high percentage of armyworms are soon destroyed by parasitic tachinid flies and parasitic wasps. Grasshoppers are parasitized by nematodes, mites, and tachinid flies; preyed upon by robber flies, quail, pheasants, and foxes; and subjected to a naturally occurring fungus disease. Grasshopper eggs are destroyed by certain mites, blister beetle larvae, and other predators. The tiny Hessian fly is parasitized by even smaller wasps. In years with favorable moisture, chinch bug populations may be decimated by a white fungus. The take-all root rot fungus is suppressed by bacteria which build up in fields continuously cropped to wheat.

Because beneficial organisms are complex, and because their requirements vary, there is no single cultural practice that will aid all these beneficial organisms. Beneficial organisms require at least low populations of pest species upon which they feed. Therefore, insecticides should only be used in fields where the economic threshold is reached.

More beneficial insects are usually present where several kinds of crops are grown. Many of these organisms are abundant in alfalfa and they migrate to other crops when alfalfa is cut. During the winter, winter wheat shelters many beneficial organisms,

## Pest Control

and when the wheat ripens they move to other crops where they destroy pests.

The Kansas Department of Agriculture rears, releases and promotes the spread of tiny wasps which attack the eggs, larvae and pupae of the alfalfa weevil.

Hedge rows, weedy fence lines, roadsides, and strip cropping generally favor beneficial species but may also favor certain pests. This emphasizes the need for a thoughtful approach to pest control efforts.

Many other organisms such as spiders and praying mantids feed on a wide array of insects, and their beneficial presence must always be considered.

### Cultural Control

Planting, growing, harvesting, and tillage practices may influence pest problems.

Changing the cropping sequence helps reduce infestations of diseases, insects, and weeds that develop in a crop. If wheat is infected with take-all root rot, rotate to a row crop for at least a year to control this disease. This practice also helps reduce the disease tan spot, the seedling blights, and insects such as annual white grubs, brown wheat mites, false wireworms, and wireworms.

Cultivating helps control weeds but may result in the spread of diseases and nematodes.

Changes in cropping sequence, as a weed control practice, have been used less extensively since the development of herbicides. Weed infestations often increase if the same crop is produced on the same land year after year. For example, winter annual grasses such as downy brome, cheat, and jointed goatgrass increase in continuous wheat. Although some herbicides can be used to control some winter annual grasses in some varieties of winter wheat, planting a row crop for at least two and preferably three years is still an effective and economical practice to reduce winter annual weed populations. Planting

wheat for one or more years also helps control shattercane, which infests row crops such as grain sorghum and corn. Perennial weeds such as field bindweed and Johnson grass are more difficult to control than annual weeds. For cost-effective control of perennial weeds use tillage, herbicides, and changes in cropping sequence in an integrated weed management program.

### Mechanical-Physical Control

Some physical methods and examples of their use are as follows:

- traps for rats, mice, and birds,
- barriers to protect against termites, rodents, and flies,
- light to attract or repel pests,
- sound to kill, attract, or repel pests,
- heat to kill pests,
- cold to kill pests,
- radiation to sterilize or kill pests, and
- electrocution to kill pests.

### Legal Control

Legal controls result from federal, state, or local laws and regulations. They include such things as quarantines, inspections, embargoes, and compulsory crop or product destruction.

### Sanitation

Removing the source of food helps control some types of pests. Fly, rodent, and cockroach control is often hard unless you remove the food or filth they feed on.

Practices that remove crop or weed hosts for pests are also examples of sanitation. Volunteer wheat provides food and shelter for Hessian flies and wheat curl mites. Wheat streak mosaic virus may also build up in volunteer wheat and this virus can be transmitted by wheat curl mites to planted wheat. Destruction of volunteer wheat breaks the cycle by removing the summertime link between the two wheat crops.

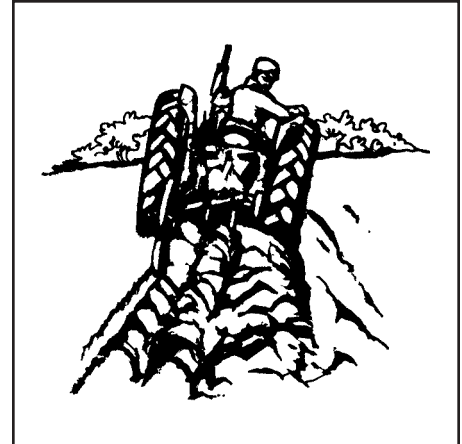

Cultural Control

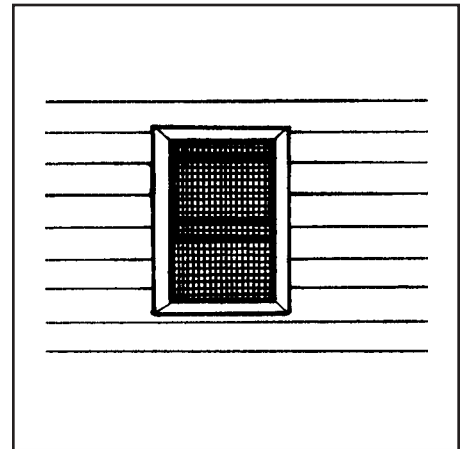

Mechanical-Physical Control

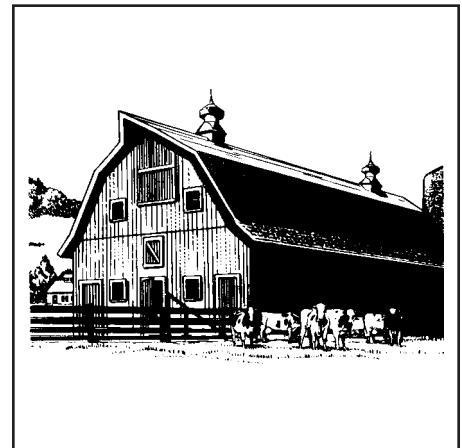

Sanitation

---

## Pest Control

---

---

---

---

Thorough cleaning of machinery moving from farm to farm or from field to field is another example of sanitation. This practice prevents the spread of weed seeds, rhizomes of perennial weeds, destructive nematodes, disease organisms, and some insects. To avoid an increase in disease and weed infestations plant only cleaned certified seed.

Sanitation of certain farm machines is required under the Kansas Noxious Weed Law as follows:

It shall be unlawful for any person, company or corporation to

1. bring any harvesting or threshing machinery, portable feed grinders, portable seed cleaners, or field ensilage cutters or other farm vehicles or machinery into the state without first cleaning such equipment free from all weed seed and litter, or
2. to move any harvesting or threshing machines, portable feed grinders, portable seed cleaners, or field ensilage cutters from any field or farm infested with any noxious weed without first cleaning such equipment free from all weed seed and litter. Each such machine operated by a person doing work for another shall be labeled with an appropriate label on a form provided by the law. (K.S.A. 2-1327)

### Pesticides

Pesticides often must be used. Other methods cannot always prevent harmful pest levels. Use pesticides where they are needed and where they can be used safely.

Pesticides can help the environment when they are used carefully and wisely. For years they have been used to control pests which are harmful to humans. With the help of pesticides, we produce food, feed, and fiber. Forests, ornamentals, buildings, and turfgrass plantings can be protected. Diseases, insects, and other plant pests can be greatly reduced.

There can be higher yields and better crop quality using less land to produce more food products.

Pesticides can be used to enhance outdoor activities in parks and camping areas. Fly and mosquito control programs give relief from the annoying pests. Aquatic pest control programs help keep lakes and waterways usable for swimming, boating, and fishing.

Pesticides protect livestock and domestic animals from harmful and annoying pests. The quantity and quality of livestock products—milk, eggs, meat, wool, and leather—are improved when pests are controlled.

Herbicides help keep rights-of-way clear of weeds. Highways, runways, train tracks, and utility right-of-way must be weed-free to allow safe, unobstructed traffic flow. Barnyards, warehouses, utility lines, and other similar areas are safer when herbicides are used to keep weeds out.

By selecting pesticides wisely and applying them correctly, the responsible pesticide applicator can use these chemicals for the benefit of the environment.

Select and use pesticides so they work with other methods. Be careful not to harm yourself or the environment. Using pesticides along with other methods is often better than using any one method by itself.

**Always read and follow all label directions.**

### Putting It All Together

The combination of methods you choose will depend on the *kind* and *level* of control you need. The three main types of controls are:

#### Prevention

Prevention means keeping a pest from becoming a problem. This includes sanitation, treated seed, pesticides, cultural controls, quarantines, seed certification, and resistant plants, animals or wood.



### Suppression

Suppression means reducing pest numbers or damage to an acceptable level. Suppression includes use of such things as:

- sanitation,
- resistant plants, animals, or wood,
- pesticides, and
- cultural controls.

### Eradication

Destroying or removing a pest completely from a crop, an area, or a geographic region is the goal of eradication but often may be impractical

or impossible. Some state and federal laws require eradication of certain pests, mostly of foreign origin.

### Summary

Remember, the most important principle of pest control is using a pest control method only when that method will prevent the pest from causing more damage than is reasonable to accept.

Even though a pest is present, it may not do very much harm. It could cost more to control the pest than would have been lost because of the pest's damage.

# Pesticides

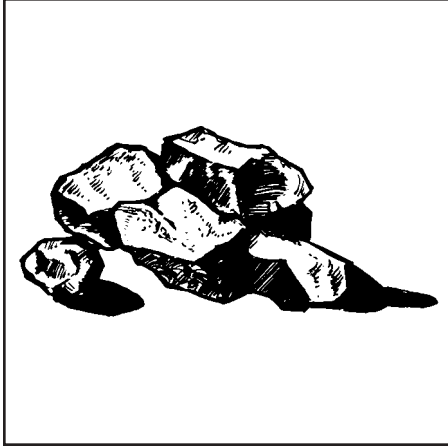

Inorganic

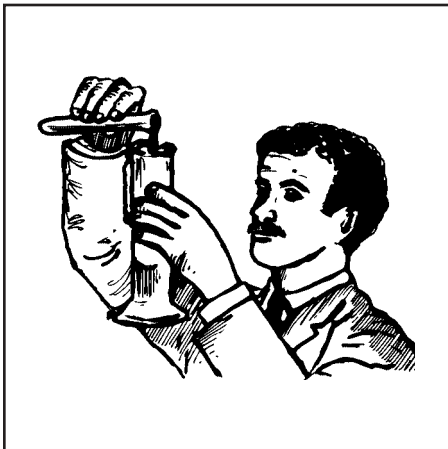

Synthetic Organic

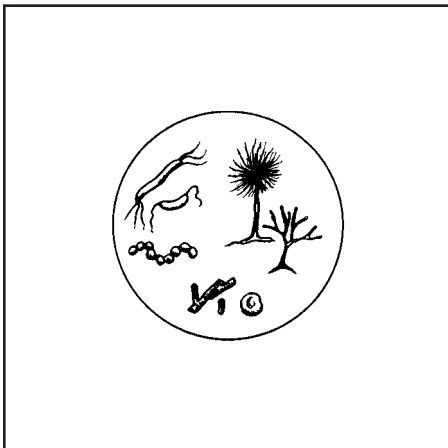

Micro-organisms

After considering all available control methods, you may decide that a pesticide is needed. Here are some things you should know in order to choose the right pesticide and use it most effectively.

Pesticides are chemicals used to destroy, prevent, or control pests. They also include chemicals used to attract or repel pests, and chemicals used to regulate plant growth or remove or coat leaves.

## Pesticide Types

**Insecticide:** controls insects and other related pests such as ticks and spiders.

**Miticide:** control mites.

**Acaricide:** controls mites, ticks, and spiders.

**Nematicide:** controls nematodes.

**Fungicide:** controls fungi.

**Bactericide:** controls bacteria.

**Herbicide:** a chemical used to control, suppress, or kill plants.

**Rodenticide:** controls rodents.

**Avicide:** controls birds.

**Piscicide:** controls fish.

**Molluscicide:** controls mollusks, such as slugs and snails.

**Predicide:** controls vertebrate pests.

**Repellent:** keeps pests away.

**Attractant:** lures pests.

**Plant Growth Regulator:** stops, speeds up, or otherwise changes normal plant processes.

**Defoliant:** a chemical which causes the leaves to drop from a plant.

**Desiccant:** dries plant tissues and insects.

**Antitranspirant:** coats the leaves of plants to reduce unwanted water loss (transpiration).

## Sources of Pesticides

Pesticides can be grouped according to their chemical nature. The groups are:

## Inorganic Pesticides

These are made from minerals. Minerals used most often are copper, boron, sulfur, tin, and zinc. Examples: Bordeaux mixtures, and zinc phosphide.

## Synthetic Organic Pesticides

These are man-made pesticides and comprise the largest group. They contain carbon, hydrogen, and one or more other elements such as chlorine, phosphorous, and nitrogen. Examples: 2,4-D, atrazine, captan, parathion, and malathion.

## Living Micro-organisms

These are viruses, bacteria, and fungi, cultured by humans.

Examples: the bacterium *Bacillus thuringiensis* and the polyhedrosis virus.

## Plant-Derived Organic Pesticides

These are made from plants or plant parts. Examples: rotenone, red squill, pyrethrins, strychnine, and nicotine.

## How Pesticides Work

Pesticides also can be grouped according to what they do. Many synthetic organic pesticides work in more than one way. Read the label to find what each pesticide will do. The major groups are:

**Protectants:** applied to plants, animals, structures, and products to prevent entry or damage by a pest.

**Sterilants:** make pests unable to reproduce.

**Contacts:** kill pests simply by contacting them.

**Stomach poisons:** kill when swallowed.

**Systemics:** an insecticide or fungicide taken into the blood of an animal or sap of a plant. They kill the pest with little or no harm to the host, plant, or animal (see translocated).

**Residual:** any pesticide that remains active over a period of time.

---

## Pesticides

---

**Translocated:** usually refers to a herbicide that is moved within the plant from one location to other parts of the plant. Frequently the term refers to herbicides applied to the foliage which move downward to underground parts (see systemic).

**Fumigants:** gases which kill when they are inhaled or otherwise absorbed by the pest.

**Anticoagulants:** prevent normal clotting of blood.

**Selective:** more toxic to some kinds of pests than to others.

**Nonselective:** toxic to most plants or animals.

**Pheromones:** affect insect pests by changing their behavior.

### Using Pesticides

Many terms used in labeling describe when and how to use pesticides. They also are found in leaflets and bulletins that you may get from your local Cooperative Extension agent or Kansas State University. You should know and understand these terms. They help get the best results from your pesticides with the least possible harm to you and the environment.

### When To Apply

Terms that tell you when to use the pesticide product:

**Preplant:** applied on the soil surface before the crop is planted.

**Preemergence:** applied before crop or weeds emerge.

**Postemergence:** applied after the crop or weeds have emerged.

### How to Apply

Terms that tell you how to use the pesticide product:

**Band:** application to a strip over or along a crop row or on or around a structure.

**Basal:** application to stems or trunks at or just above the ground line.

**Broadcast:** uniform application to an entire field area.

**Crack and crevice:** application in structures to cracks and crevices where pests may live.

**Dip:** complete or partial immersion of a plant, animal, or object in a pesticide.

**Directed:** aiming the pesticide at a portion of a plant, animal, or structure.

**Drench:** saturating the soil with a pesticide or oral treatment of an animal with a liquid pesticide.

**Foliar:** application to the leaves of plants.

**In-furrow:** application to or in the furrow in which a plant is planted.

**Over-the-top:** application over the top of the growing crop.

**Pour-on:** pouring the pesticide along the midline of the back of livestock.

**Sidedress:** application along the side of a crop row.

**Soil application:** application to the soil rather than to vegetation.

**Soil incorporation:** use of tillage implements to mix or blend the pesticide into the soil.

**Soil injection:** application beneath the soil surface.

**Spot treatment:** application to a small area.

### Accuracy Is Important

The *rate* and *time* of application of pesticides are critical. Most pesticides work at very low rates. If you use too much, they can harm or even kill the plant or animal you wish to protect. Pesticides work best when applied at specific times. Applying them before or after the correct time reduces or even eliminates their effectiveness.

Since all these chemicals work in small amounts, be careful to treat only the intended target. Avoid getting them on anything else as a result of drift with wind currents, or of residue in application equipment or soil. Pesticide movement off of the target area is generally inconsistent with the pesticide's labeling and is a violation of state and federal laws.

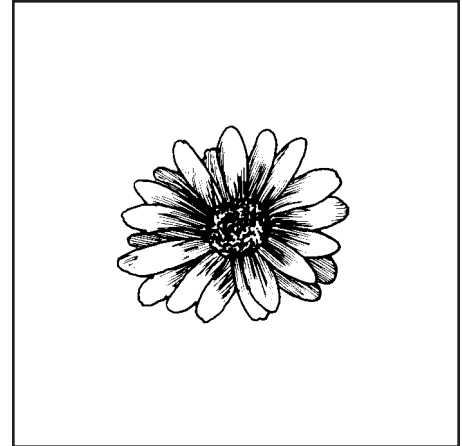

Plant-Derived Organic

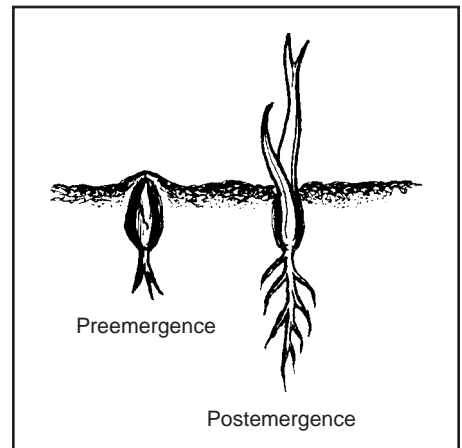

When To Use

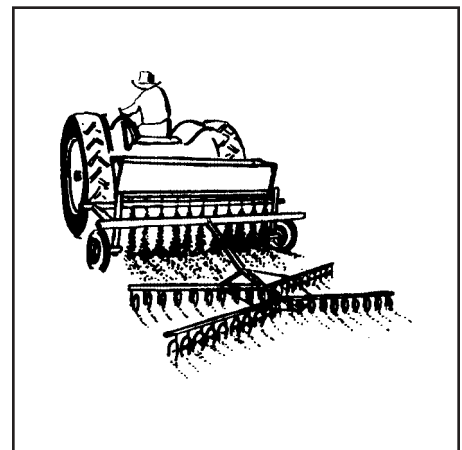

Soil Incorporation

# Pesticides

## Recordkeeping Is Important

Keeping records is a very important business practice. By keeping accurate records of when pesticides were applied to which fields, at what rates, for what pests, etc., you will be better able to manage your future pesticide applications and overall farming operations. For information on the recordkeeping requirement provisions of the 1990 Farm Bill, refer to the chapter on "LAWS AND REGULATIONS" at the end of this manual.

## Factors Affecting Pesticide Activity

### Soil Factors

*Organic matter* in soils may limit pesticide activity. Soils with high organic matter content may need higher rates of pesticides for good pest control. Follow label instructions.

*Soil texture* also affects the way pesticides work. Soils with fine particles (silts and clays) provide the most surface area. They may need higher rates. Coarser soils (sands) have less surface area and may need lower rates. Follow label instructions.

### Weather Factors

*Soil moisture and rain* affect the way pesticides work. They also affect how long pesticides stay on soil and plants. Pesticides work best with moderate soil moisture. Wetness may keep the pesticide from contacting the soil particles. Rain causes soluble pesticides to leach down through the soil. Rain is good when preemergence pesticides are applied to the surface. It carries them down into the soil to the roots. But rain after over-the-top or foliar applications is not good. It may wash pesticides off the leaves. The pesticide should be allowed to dry on the leaves before exposure to rain or irrigation. This time span will vary depending on mode of application, crop type, temperature, and humidity.

*Humidity and temperature* also affect the way pesticides work. Herbicides work best when plants are growing fast. High relative humidity and optimum temperatures usually cause this fast growth. High temperatures cause some pesticides to evaporate quickly. Low temperatures may slow down or stop the activity of some pesticides.

*Light* may break down some pesticides if they are left on the soil surface.

## Pesticide Resistance

The ability of pests to resist poisoning is called *pesticide resistance*. Consider this when planning pest control programs that rely on the use of pesticides.

Rarely does any pesticide kill all the target pests. Each time a pesticide is used, it selectively kills the most sensitive individuals. Some pests avoid the pesticide. Others are able to withstand its effects. Pests that are not destroyed pass along to their offspring the trait that allowed them to survive.

When we use one pesticide repeatedly in the same place, the pest population sometimes builds up its resistance. Some pests have become practically immune to poisoning by certain pesticides.

A recent example of pesticide resistance in Kansas is seen with the extensive use of eartags containing pyrethroid insecticides to control horn flies. In some areas, after two years of use, horn flies were no longer controlled and other products had to be used.

The most important factors to manage to reduce the development of pesticide resistance include:

- pesticide type—persistent chemicals lead to resistance.
- high levels of control—the higher levels of control lead to resistance, and
- wide areas of coverage can encourage resistance.



Recordkeeping

Not every pesticide failure is caused by pest resistance, however. Make sure that you have:

- used the correct pesticide,
- used the correct dosage, and
- applied the pesticide correctly.

Your Cooperative Extension Service can help you find out why you did not get the desired results.

### Plant Growth Regulators, Desiccants, Defoliants, and Antitranspirants

Plant growth regulators, desiccants, defoliants, and antitranspirants change normal plant processes. Each works in a different way.

#### Plant Growth Regulators

All plant parts are made of tiny cells which continually multiply and grow. Plant growth regulators speed up, slow down, or otherwise affect cell growth and reproduction. Here are some ways they are used:

- decrease preharvest drop,
- increase fruit firmness,
- reduce scald,
- delay water core (water-soaked area around core of fruit),
- increase red color,
- thin fruit,
- increase flowering,
- reduce Fruit cracking,
- promote uniform bearing of fruit,
- control plant height,
- prevent or delay sprouting of tubers,
- promote dense growth of landscape plants,
- promote earlier flowering,
- prevent seed formation,
- induce branching,
- reduce suckering,
- hasten fruit maturity,
- increase seed yield, and
- control excessive growth.

#### Desiccants and Defoliants

These often are called harvest-aid chemicals, because they help the farmer harvest his crop. Both are

used to get rid of leaves, stems, and weeds in such crops as cotton, soybeans, and potatoes.

#### Antitranspirants

By reducing water loss, antitranspirants can prevent winter damage, maintain color in evergreens, protect against salt damage, help protect transplants, and prevent needle drop on Christmas trees.

### Types of Formulations

Active ingredients are the chemicals in a pesticide that do the work. Other ingredients may be added to make them convenient to handle and safe and easy to apply. These are the inert ingredients. This mixture of active and inert ingredients is called a *pesticide formulation*. Some formulations are ready for use. Others must be diluted with water or a petroleum solvent. The directions for use will tell you how to use a pesticide formulation.

Here are the most common types of liquid and dry formulations. The abbreviations are included because Extension Service recommendations and the labels may refer to the formulations in this way.

#### Liquid Formulations

There are six basic kinds of liquid formulations:

1. Emulsifiable concentrates,
2. Microencapsulation,
3. Solutions,
4. Flowables,
5. Aerosols, and
6. Liquified gases.

#### Emulsifiable concentrates (EC)—

These can be mixed with water to form emulsions. Each gallon of an EC usually contains 2 to 8 pounds of active ingredient. Diluted EC's usually need little agitation in the spray tank.

EC's can damage some crops.

These crops may require a different formulation of the active ingredient such as a wettable powder or a dust.

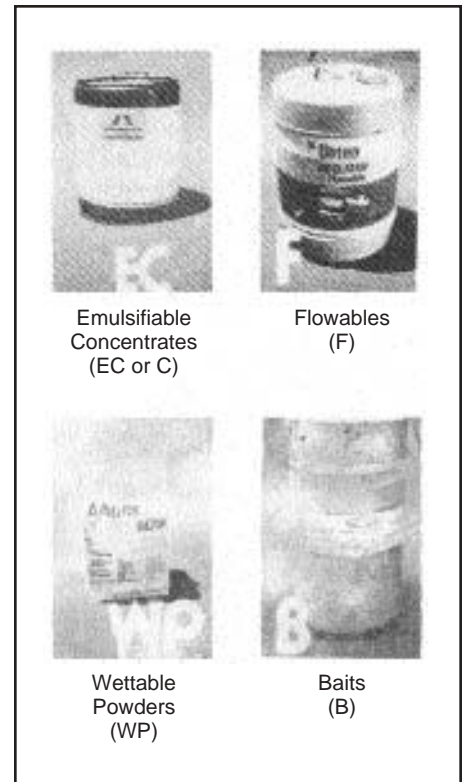

Formulations



---

## Pesticides

---

---

---

---

**Microencapsulation**—microencapsulated formulations are microscopic particles of pesticides (either liquid or dry) surrounded by a very thin plastic coating. The formulated product is mixed with water and applied as a spray. Once applied, the capsule slowly releases the pesticide. The encapsulation process can prolong the active life of the pesticide by providing a timed release of the active ingredient.

Microencapsulated formulations are easy to mix, handle, and apply and therefore increase safety to the applicator. However, they need constant agitation in the tank. Also, sometimes bees may pick up the capsules and carry them back to the hives where the released pesticide may poison entire hives.

**Solutions**—High concentrates are special formulations. They usually contain 8 or more pounds of active ingredient per gallon. They may contain only the active ingredient itself. Most are designed to be used as is or diluted with oil or petroleum solvents. They contain chemicals that allow them to spread and stick well. Ultra-low-volume (ULV) concentrate materials should be used without further dilution.

Low concentrates are formulations usually containing less than 2 pounds of active ingredient per gallon. Most of them are solutions in highly refined oils. They need no further dilution. The label will give you directions for use. They are often used for controlling household and industrial pests, mothproofing, livestock sprays, or space sprays in barns.

**Flowables**—Some active ingredients can be made only as a solid, or at best, a semisolid. These are finely ground and put into a liquid along with other substances that make the mixture form a suspension. They are *flowable solids*. Flowables can be mixed with water. They seldom clog spray nozzles. They need only moderate agitation. Most of them handle as well as EC formulations.

**Aerosol** pesticide formulations are liquids that contain the active ingredient in solution in a solvent. More

than one pesticide may be in these formulations. Most aerosol formulations have a low percentage of active ingredient. They are made for use only in fog or mist generating machines. They are used in structures, greenhouses, and barns for insect control.

**Liquified gases** are fumigants which become liquid when placed under pressure. This type formulation is stored under pressure. The pressure may be either high or low, depending on the product. Some nematocides, insecticides, fungicides, and rodenticides are formulated this way. These formulations are applied by injecting them directly into the soil, releasing them under tarps, or releasing them into a structure such as a grain storage elevator.

Some other active ingredients remain liquid or solid in an ordinary container, but turn into a gas or vapor as or after they are applied. These formulations do not require storage under pressure. They must be put into the soil or confined in a space before they turn to gas. Otherwise, they could be lost into the air.

### Dry Formulations

Dry formulations include:

1. Dusts,
2. Granules,
3. Water dispersible granules (Dry flowables),
4. Wettable powders,
5. Soluble powders,
6. Pellets, and
7. Baits.

**Dust formulations** are ready to use and contain an active ingredient, plus a fine or powdered dry inert substance such as talc, clay, nut hulls, or volcanic ash. The amount of active ingredient usually ranges from 1 to 10 percent.

All the ingredients are ground into fine, uniform particles. Inert ingredients are often added so the formulation will store and handle well. Some active ingredients are prepared as dusts because they are safer for crops in that form. Dusts always must be

used dry. They can easily drift into non-targeted areas. You can get dusts for use on seeds, plants, and animals.

**Granular formulations** are dry. Most are made by applying a liquid form of the active ingredient to coarse particles (granules) of some porous material. Clay, corn cobs, or walnut shells are often used. Granule particles are much larger than dust particles. The pesticide is absorbed into the granule, or coats the outside, or both. The amount of active ingredient ranges from 2 to 40 percent.

Granular formulations are safer to apply than EC's or dusts. They are most often used for soil treatments. They may be applied either directly to the soil or over plants. They do not cling to plant foliage, but they may be trapped in the whorls of some plants. Granular formulations, like dusts, should always be used dry. Never mix them with water.

**Water dispersible granules or (dry flowables)** are a dry granular flowable formulation which is dispersible in water. Agitation in the tank is required. While these formulations look similar to the granular formulations (discussed above), they are much different in that they must be mixed in water and are at a much higher concentration, generally 75 to 90 percent active ingredient in the dry state. These formulations of products are described as DF—Dry Flowable or Water Dispersible Granules.

**Wettable powders (WP)** are dry, finely ground pesticide formulations. They look like dusts. But, unlike dusts, they are made to mix with water. Most wettable powders are much more concentrated than dusts. They contain 15 to 95 percent active ingredient—usually 50 percent or more.

Wettable powders form a suspension rather than a true solution when added to water. Good agitation is needed in the spray tank to maintain the suspension. Good wettable powders spray well and do not clog nozzles. They are abrasive to pumps and nozzles. Most wettable powders are safer for use on plants than are EC's.

**Soluble powders (SP)** also are dry formulations. But when they are added to water, they form true solutions. Agitation in the spray tank may be needed to get them to dissolve. After that, no more agitation usually is needed. The amount of active ingredient in an SP is usually above 50 percent.

**Pelleted formulations** are uniform sized particles, usually of clay or similar material. The particles of uniform size and specific weight, are created by extruding or molding under pressure. The active ingredient is usually absorbed into the pellet and released by water into the soil. The amount of active ingredient ranges from 1 to over 40 percent.

Pelleted formulations are most often used to apply pesticides to the soil to control weeds, brush, and nematodes. They are applied by aircraft, ground applicators, and spot treatment methods.

A **bait formulation** is an edible or attractive substance mixed with a pesticide. The bait attracts pests and the pesticide kills them when they eat the formulation. Baits usually are used to control rodents and insect pests. They can be used in buildings or outdoors. The amount of active ingredient in most bait formulations is quite low, usually less than 5 percent.

### Fumigant Formulations

**Fumigation is relatively complicated, requires specialized training and well-maintained application, monitoring, and safety equipment, and can be fatal to the user if recommended procedures are not closely followed. Unless willing to invest the time and money necessary to acquire the equipment and knowledge needed, this job should be left to reputable professionals.**

**Fumigants do not provide any residual protection so reinfestation can occur immediately after the grain or other treated product has been "aired out" and gas concentrations fall below lethal levels.**



---

## Pesticides

---

---

---

---

---

Fumigants are compounds that become gases at ordinary temperatures. Fumigation is pest control with gases. Various aerosol space sprays and the bug bombs that are frequently used in household pest control are not true fumigants. Most fumigants are highly penetrating, capable of reaching into cracks and crevices and through large masses of materials to kill insects and certain other organisms that could not otherwise be reached. They may be the only practical means of pest control in stored grain, stored commodities, or for soil fumigation. Fumigants are very hazardous to handle (See Flammability Table, p. 37); they are almost as toxic to humans as they are to the pests that we are trying to control.

All fumigants are RESTRICTED USE pesticides and as such can only be obtained legally by certified pesticide applicators. Fumigants should only be applied by persons who have been trained in proper, safe application procedures.

Three general types of fumigants are available based on formulations. Aluminum phosphide is a solid material which produces toxic phosphine gas. It is applied in the solid form, either as tablets or pellets; forms that are easier and safer to apply than other fumigants. It is purchased in the solid form either as pellets or tablets and often is safer to use than other fumigants. Once the tablets are removed from the flask, however, the moisture in the air reacts with the chemical to form phosphine gas, which once released, is highly toxic to man. For use in grain, tablets are usually probed into the grain after it has been placed in storage. Pellets are usually added to a grain stream as the grain is transferred from one bin to another. Applying tablets or pellets to grain being augered into a bin at harvest time is not advisable because gas released may escape from the bin before the bin is filled.

Chloropicrin is formulated as a liquid and changes rapidly into a gas in temperatures above about 40°F. Labeling restricts chloropicrin to

empty bin treatments to eliminate existing infestations. No grain should be present.

Methyl bromide is an example of a gas fumigant. It is a gas at ordinary temperatures and is therefore packaged in special pressurized cylinders similar to oxygen, propane, and other gases. Gas fumigants are used primarily by industrial or commercial firms, although one pound canisters of methyl bromide were formerly available for soil fumigation uses. Concerns about environmental hazards (ozone depletion) make it likely that this product will become less available.

### **Liquid Fumigant— Chloropicrin (CP)**

*Properties:* Clear liquid with intense irritating odor which makes it a powerful tear gas; vaporizes readily into a heavy gas; high sorption rate into grain gives poor penetration into grain masses. CP is substantially heavier than air and therefore has a tendency to flow out of any opening in the lower portion of treated structures. It is one of the most toxic fumigants to insects but has limited use because of the tear gas effect. CP is also injurious to plants. *Fire hazard:* Nonflammable.

*Human hazard:* One part per million (1 ppm) in air produces intense smarting pain in the eyes and irritation of the respiratory tract (tear gas effect). Man's immediate reaction is to leave the vicinity quickly which is fortunate because continued exposure to this level could cause serious lung injury.

*Uses:* READ THE LABEL. Uses are limited because of the tear gas effect and because fumigated commodities are unpleasant to handle for some time after fumigation.

One of the few remaining uses of this product is in disinfecting empty bins, particularly the area beneath perforated floors used in aeration. Chloropicrin should not be used to fumigate grain held for planting because it can significantly reduce germination.

**Gas Fumigant—  
Methyl Bromide (MB)**

*Properties:* Colorless, odorless gas which is heavier than air and penetrates commodities and grain masses readily; easily removed by aeration. *Fire hazard:* Nonflammable at usage levels (flammable at 13.5 to 14.5% in air). Extinguish pilot lights and flames in building before using.

*Human Hazard:* Use requires extreme caution because of lack of odor. Liquid MB will cause severe blisters on contact with skin. Tests with a halide leak detector will indicate highly dangerous concentrations by a light green to dark green to blue green to blue flames. Use detector tubes or thermal conductivity apparatus for proper monitoring for MB gas concentrations in air. Gas concentrations below 5 ppm do not require respiratory protection; 5 ppm or greater require positive pressure self-contained breathing apparatus. Exposure brings neurological symptoms (headaches, incoordination, visual disturbances). Monthly blood bromide tests are suggested for those using or exposed to MB. Chronic effects often irreversible. Delayed appearance of symptoms and lack of odor make this fumigant very hazardous to use.

*Uses:* READ THE LABEL. Good penetration into commodities. MB readily penetrates flour and milled products and has been used for that purpose. Certain commodities (iodized salt, sponge rubber, leather goods, viscose rayons, photo chemicals, etc.) should not be exposed to MB.

**Solid Fumigant—Aluminum Phosphide (Phosphine (PP))**

*Properties:* Tablets or pellets of aluminum phosphide react slowly with moisture in the air to evolve phosphine gas (PP). Ammonium carbamate is included in some formulations and decomposes to give off carbon dioxide and ammonia. These gases dilute the PP and reduce the danger of spontaneous combustion.

*Fire hazard:* Highly flammable at 1.79% in air (and up) which is considerably above the usage concentration. Reacts with all precious metals and especially copper causing severe corrosion; therefore, all wiring, motors, switches and other electrical equipment must be protected or removed.

*Human hazard:* Highly toxic to man. The maximum safe exposure limit (for 40 hr/week) is 0.3 ppm (.00003% air). Garlic odor warns of toxic concentrations but may not always be present when PP is above 0.3 ppm. Detector tubes must be used to ensure safe working levels for employees. Symptoms include fatigue, buzzing in ears, nausea, pressure in chest, intestinal pain, diarrhea and vomiting. Phosphine apparently is not chronic and is not absorbed by the skin in appreciable amounts. Notify your physician of PP exposure.

Below 0.3 ppm of phosphine gas in the air no protection is needed, between 0.3 and 15 ppm users must at least wear a NIOSH/MSHA-approved canister gas mask and filter capable of protecting the user from phosphine vapors. Above 15 ppm, a positive pressure self-contained breathing apparatus must be worn. WHERE GAS CONCENTRATIONS ARE UNKNOWN YOU MUST USE A SELF-CONTAINED BREATHING APPARATUS.

*Uses:* READ THE LABEL. Usually introduced into the grain by automatic injectors as the grain flows into storage bins in commercial storage structures. Usually placed into farm stored grain masses through the use of special probes. Some aluminum phosphide labels may allow placement of a portion of the dose below

**Table: Grain Fumigant Flammability**

Fumigant	Flammability (Explosive concentrations in air)
Chloropicrin	Nonflammable
Phosphine	Very (1.79%)*
Methyl bromide	Nonflammable

\*Phosphine reacts with copper and copper alloys giving severe corrosion. Such metals should be protected from the gas.

---

## Pesticides

---

---

---

---

---

perforated floors to eliminate hidden infestations if the area is free of moisture. **Caution:** Contact of tablets or pellets with standing water can lead to autoignition (explosion). **Read and follow instructions.**

### Using the Correct Formulation

One formulation may be legal to use on a pest while another formulation of the same chemical may be illegal, so read and follow the label.

When applying pesticides to agricultural animals, consider how the pesticide formulation will affect them. Sprays are generally suited for treating most animals except in freezing weather. Some pour-ons, smears and dust formulations are recommended in cold weather. Do not let oil sprays penetrate the hair to the animals' skin in any weather unless directed on the label.

### Adjuvants

Adjuvants are added to a pesticide formulation or spray solution to increase the effectiveness of the active ingredient. Most pesticide formulations contain at least a small percentage of additives. Some applicators add additional adjuvants while mixing for special applications. Some product labels may caution the user against adding adjuvants. Common adjuvants are:

**Wetting agents**—allow wettable powders to mix with water and stick on plant or animal surfaces.

**Emulsifiers**—allow petroleum-based pesticides (EC's) to mix with water.

**Invert emulsifiers**—allow water-based pesticides to mix with petroleum carrier.

**Spreaders**—allow pesticide to form a uniform coating layer over the treated surface.

**Stickers**—allow pesticide to stay on the treated surface.

**Penetrants**—allow the pesticide to get through the outer surface to the inside of the treated area.

**Drift retardants**—may help reduce spray drift by decreasing the quantity of fine spray droplets.

**Thickeners**—may reduce drift by increasing droplet size.

**Safeners**—reduce phytotoxicity of pesticide to protected crop.

**Compatibility agents**—aid in combining pesticides effectively.

**Buffers**—allow mixing of pesticides of different acidity or alkalinity.

**Anti-foaming agents**—reduce foaming of spray mixtures that require vigorous agitation.

### Compatibility

Two or more pesticides which can be mixed together to control a wider range of pests with a single application are said to be compatible with each other. Sometimes the pesticides are formulated together by the manufacturer, but the applicator often must mix separate formulations in the tank. It is important to remember that not all pesticides work well in combination. Pesticides which are not compatible can cause:

- loss of effectiveness against the target pests,
- injury to the treated surface (phytotoxicity in plants, toxicity in treated animals, stains or corrosion on treated surfaces), and
- separation of ingredients into layers or settling out of solids.

Some pesticide labels list other pesticides with which the product is compatible. Pesticide publications, land-grant universities, and independent experts can supply information based on local experience. Be careful with do it yourself mixes; they could cost you time and money.

Each time you buy a pesticide, you also receive instructions to tell how to use it. Those instructions are the labeling.

What is labeling? What is a label? These Words seem alike but they do not mean the same thing.

**Labeling** is all information that you receive from the company or its agent about the product. Labeling includes such things as:

- the label on the product,
- brochures,
- flyers, and
- information handed out by your dealer.

The **label** is the information printed on or attached to the container of pesticides. This label does many things:

- To the manufacturer, the label is a "license to sell."
- To the State or Federal Government, the label is a way to control the distribution, storage, sale, use, and disposal of the products.
- To the buyer or user, the label is a main source of facts on how to use the product correctly and legally.
- The label is a way to tell users about special safety measures needed.

Some labels are easy to understand. Others are complicated. But all labels will tell you how to use the product correctly. Anyone who uses pesticides is responsible by law for following label directions. This section will explain the items that must be on a label.

## Pesticide Registration in Kansas

There are four basic ways for registering pesticides: (1) Federal Registration, (2) Special Local Needs (Section 24(c)) Registration, (3) Emergency Exemptions (Section 18), and (4) Experimental Use Permit. All pes-

ticides intended for sale and use in Kansas must be registered with the Kansas State Board of Agriculture.

1. **Federal Registration** is the normal or usual method by which a pesticide is labeled and becomes commercially available. A Federal Registration is issued by the EPA on a national basis so that the labeled product is available to all states or in some cases all states within a specified region. The research information needed for a Federal Registration generally comes from throughout the country, and in many cases, research data from Kansas is incorporated into the total registration data. Residue tolerances are set for all labeled uses and represent the maximum amount of a particular chemical that may safely remain in or on raw agricultural products at the time of sale. Obtaining a Federal Registration is the responsibility of the pesticide industry working with EPA.

2. **Special Local Needs Registrations (SLN), Section 24(c)**. The Federal Pesticide Law (FIFRA) allows individual states to register pesticides for special needs within the state. To do so, the proposed use must already have a **tolerance** if it is to be used on a raw agricultural product. It must **not** result in unacceptable exposure or damage, and it must be necessary, effective, and safe. An SLN must have the manufacturer's support and although they are usually initiated by the manufacturer, anyone can initiate an SLA. The SLA label is a supplement to the Federal label and must be in the possession of the user when the product is being applied.

3. **Emergency Exemption**. Section 18 of the Federal Pesticide Law allows EPA, in consultation with the Secretary of Agriculture and the Governor, to exempt certain necessary pesticide uses from the registration requirements of the law. This style of exemption requires that some type of emergency condition exists. Generally, the Emergency Exemption is obtained to allow the limited use of a pesticide on a particular farm



## Labels and

## Labeling

product for which a tolerance has not been established. The requirements for obtaining and using an Emergency Exemption are strict and time consuming.

### 4. *Experimental Use Permits (EUP).*

An EUP is usually obtained by the company producing the particular pesticide and is used by the company to obtain the information needed to register that pesticide for a certain use. Pesticides available under an EUP are to be distributed or sold only to persons who have agreed to participate in an experimental program. A person who uses an EUP product must follow the permit and label directions (as required for all pesticides) and should cooperate in reporting the results of use to those who supply the product.

## Parts of the Label

### Brand Name

Each company has brand names for its products. The brand name is the one used in ads. The brand name shows up plainly on the front panel of the label. It is the most identifiable name for the product.

### Type of Formulation

Different types of pesticide formulations (such as liquids, wettable powders, and dusts) require different methods of handling. The label will tell you what type of formulation the package contains. The same pesticide may be available in more than one formulation.

### Common Name

Many pesticides have complex chemical names. Some have been given another name to make them easier to identify. These are called *common names*. For instance, carbaryl is the common name for 1-naphthyl N-methylcarbamate. A chemical made by more than one company will be sold under several *brand names*, but you may find the same *common name* on all of them.

### Ingredient Statement

Every pesticide label must list what is in the product. The list is written so that you can see quickly what the active ingredients are. The amount of each *active ingredient* is given as a percentage by weight or as pounds per gallon of concentrate. It can be listed by either the chemical name or the common name. The *inert ingredients* need not be named, but the label must show what percent of the contents they make up.

### Net Contents

The net contents number tells you how much is in the container. This can be expressed in gallons, pints, pounds, quarts, or other units of measure.

### Name and Address of Manufacturer

The law requires the maker or distributor of a product to put the name and address of the company on the label. This is so you will know who made the product.

### Registration and Establishment Numbers

A registration number must be on every pesticide label. It shows that the product has been registered with the Federal Government. It usually is found on the front panel of the label and will be written as "EPA Reg. No. 0000-00." The establishment number tells what factory made the

Signal Words	Toxicity	Approximate Amount Needed to Kill the Average Person
DANGER	Highly toxic	a taste to a teaspoonful
WARNING	Moderately toxic	a teaspoonful to a tablespoonful
CAUTION	Low toxicity or Comparatively free from danger	an ounce to more than a pint



---

## Labels and Labeling

---

---

---

---

chemical. This number does not have to be on the label, but will be somewhere on each container.

### Signal Words and Symbols

To be effective, pesticides must control the target pest. By their nature, they are toxic. Therefore, some may be hazardous to people. You can tell the toxicity of a product by reading the *signal word* and looking at the *symbol* on the label.

One of the most important parts of the label is the *signal word*. It tells you approximately how toxic the material is to people. The signal words that follow are set by law. Each manufacturer must use the correct one on every label: (see table below).

All products must bear the statement "Keep out of reach of children."

Symbols are one of the best ways to catch a person's eye. This is why a skull and crossbones symbol is used on all highly toxic materials along with the signal word DANGER and the word POISON.

Pay attention to the symbol on the label. It is there to remind you that the contents could make you sick, or even kill you.

### Precautionary Statements

*Hazards to Humans (and Domestic Animals)*—This section will tell you the ways in which the product may be poisonous to man and animals. It also will tell you about the kind of protective equipment needed to avoid poisoning.

If the product is highly toxic, this section will inform physicians of the proper treatment for poisoning.

*Environmental Hazards*—Pesticides are useful tools. Wrong or careless use of them can cause undesirable effects on the environment. The label contains environmental precautions that you should read and follow.

Here are some examples:

- "This product is highly toxic to bees exposed to direct treatment or to residues on crops."

- "Do not contaminate water when cleaning equipment or when disposing of wastes."
- "Do not apply where runoff is likely to occur."

Labels may contain broader warning against harming birds, fish, and wildlife.

*Physical and Chemical Hazards*—This section will tell you of any special fire, explosion, or chemical hazards that the product may pose.

### Worker Protection Standard

The U.S. Environmental Protection Agency's Worker Protection Standard (as revised in 1992) must be complied with when pesticide products are used on agricultural establishments (farms, forests, nurseries, and greenhouses) for the commercial or research production of agricultural plants. The Worker Protection Standard (WPS) requires employers to provide agricultural workers and pesticide handlers with protections against possible harm from pesticides. Persons who must comply with these instructions include owners/operators of the agricultural establishment and owners/operators of commercial businesses that are



Field Warning Signs

## Labels and

## Labeling

hired to apply pesticides on the agricultural establishment or to perform crop-advising tasks on such establishments. You and any family members who work on your agricultural or commercial pesticide establishment are considered "employees" in many situations and must receive some of the required protections. Some of the basic requirements the WPS establishes for employers include:

- Displaying information about pesticide safety, emergency procedures, and recent pesticide applications on an agricultural establishment.
- Training workers and handlers about pesticide safety.
- Helping employees get medical assistance in case of a work-related pesticide emergency.
- Setting up decontamination sites for washing pesticide residues off hands and body.
- Compliance with restricted-entry intervals—the time immediately after a pesticide application when workers may not enter the treated area.
- Notifying workers (through posted and/or oral warnings) about areas where applications are taking place and areas where restricted-entry intervals are in effect.
- Allowing only trained and equipped pesticide handlers to be present during a pesticide application.
- Providing personal protective equipment for pesticide handlers and also for workers who enter pesticide-treated areas before expiration of the restricted-entry interval (in the few very limited circumstances permitted by the WPS).
- Protecting pesticide handlers by giving them safety instruction about the correct use of personal protective equipment and mixing loading, and application equipment; inspecting and maintaining equipment they will be using; and monitoring them in hazardous situations.

For detailed information about your responsibilities under the WPS, get a copy of EPA's manual, "Worker Protection Standard for Agricultural Pesticides—How To Comply." It will tell you what you need to do to be in compliance with the Federal worker protection requirements. The manual may be available from EPA regional offices, State or Tribal pesticide agencies, Extension Services, pesticide dealers, the Government Printing Office, and other commercial sources.

### Endangered Species

In order to protect specific endangered species from adverse effects of pesticides, many product labels will change. They will include a statement directing users to obtain and abide by a special bulletin which identifies specific geographical areas where the pesticide may not be used. These actions are required by the Endangered Species Act.

The U.S. Fish and Wildlife Services (FWS) is the final authority for the interpretation of the Endangered Species Act, particularly for geographic areas where certain pesticides may be used with certain safeguards or are prohibited. Implementation of the endangered species labeling project will be phased in over several years.

The label will direct pesticide users to refer to county bulletins on endangered species. Bulletins referred to on the label are "labeling" and are, therefore, legal documents and enforced the same way as the label.

The Endangered Species Bulletin will include:

- a county map clearly identifying the ranges of species jeopardized by specific pesticides;
- commonly recognized borderlines such as roads, powerlines, and water bodies;
- affected pesticides listed by active ingredient;
- a list of protected endangered species;

Use of listed pesticides in identified ranges of endangered species will be prohibited or limited. EPA will make the Endangered Species Bulletins

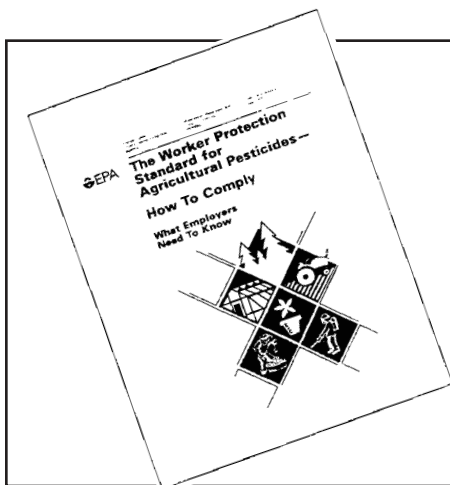

How To Comply

---

## Labels and

## Labeling

---

---

---

---

available to users through County Extension agents, pesticide dealers, and at other outlets.

At the time this manual went to press, EPA was still developing the details of this program. It appears that labeling will be in the field in the growing season of 1996. Any bulletins appearing prior to reference on the label will contain voluntary provisions.

### Statement of Practical Treatment

If swallowing or inhaling the product or getting it in your eyes or on your skin would be harmful, the label will tell you emergency first aid measures. It also will tell you what types of exposure require medical attention.

The pesticide label is the most important information you can take to the physician when you think someone has been poisoned.

### Statement of Use Classification

Every pesticide label must show whether the contents are for *general use* or *restricted use*. EPA will eventually put every product use into one of these two classes. The classification is based on the hazard of poisoning, the way the pesticide is used, and its effect on the environment.

A *general use* pesticide will harm the applicator or the environment very little or not at all when used exactly as directed.

The label on general use products DOES NOT have the "restricted use" statement shown below.

A *restricted use* pesticide is one which could cause some human injury or environmental damage even when used as directed on the label. The label on these products says:

#### **RESTRICTED USE PESTICIDE**

**For retail sale to, and use only by, Certified Applicators or persons under their direct supervision, and only for those uses covered by the Certified Applicator's certification.**

The restricted use statement must be at the top of the front panel of the label.

### Directions for Use

The instructions on how to use the pesticide are an important part of the label for you. This is the best way you can find out the right way to apply the product.

The use instructions will tell you:

- the pests the product is registered to control (Labels use common name for pests. Knowing these names will help you choose the proper pesticide and find control information),
- the crop, animal, or other item the product can be used on,
- whether the product is for general or restricted use,
- in what form the product should be applied,
- how much to use,
- where the material should be applied, and
- when it should be applied.

**Misuse Statement**—This section will remind you that it is a violation of Federal law to use a product in a manner inconsistent with its labeling. Before the product could be registered, EPA required the manufacturer to conduct many tests to be sure the label directions were correct. By following them exactly, you will get the best results the product can give, and avoid breaking the law.

**Reentry Statement**—If required for the product, this section will tell you how much time must pass before a pesticide-treated area is safe for entry by a person without protective clothing.

**Storage and Disposal Directions**—Every pesticide should be stored and disposed of correctly. This section will tell you how to store and dispose of the product and empty containers.

Following directions on the product label will help you obtain practical pest control, use the product correctly, and store it safely.

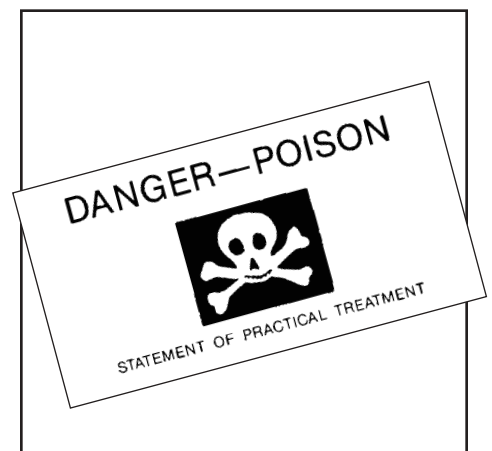

## Labels and

## Labeling

### Safe Use Precautions

People who work with pesticides have some risk of pesticide injury when they perform such tasks as:

- hauling pesticides,
- storage,
- mixing,
- calibrating equipment before use,
- loading,
- applying,
- repairing equipment,
- working in pesticide-treated crops and buildings,
- cleaning application equipment after use,
- disposing of surplus pesticides and empty containers,
- cleaning up spills, and
- cleaning protective clothing and equipment.

Some of these tasks are done indoors. Many are done outdoors. Each one requires some safety measures to prevent harm to people, animals, and plants as well as to soil and water outside the target area.

You can prevent harm from pesticides if you follow safety precautions and use common sense. Here are the *minimum* safety steps you should take.

### Before You Buy a Pesticide

**The first and most important step in choosing a pesticide is to know what pest you need to control.** Then find out which pesticides will control it. You may have a choice of several. You may need help to guide you. Common sources of information are your Cooperative Extension Service, most agricultural schools, the U.S. Department of Agriculture, and pesticide manufacturers and dealers.

### At the Time of Purchase

Read the Label of the pesticide you intend to buy to find:

- restrictions on use,
- if this is the correct chemical for your problem,
- if the product can be used safely under your conditions,

- environmental precautions needed,
- if the formulation and amount of active ingredient are right for your job,
- if you have the right equipment to apply the pesticide,
- if you have the right protective clothing and equipment, and
- how much pesticide you need.

### Before You Apply the Pesticide

Read the label again to find:

- the protective equipment needed to handle the pesticide,
- the specific warnings and first-aid measures,
- what it can be mixed with,
- how to mix it,
- how much to use,
- safety measures,
- when to apply to control the pest and to meet residue tolerances,
- how to apply,
- the rate of application,
- special instructions.

### Transportation of Pesticides

You are responsible for the safe transport of your pesticide. The safest way to carry pesticides is in the back of a truck. Fasten down all containers to prevent breakage and spillage.

Keep pesticides away from food, feed, and passengers. Pesticides should be in a correctly labeled package. Always keep paper and cardboard packages dry.

If any pesticide is spilled in or from the vehicle, clean it up right away. Use correct cleanup procedures. Do not leave unlocked pesticides unattended. You are responsible if accidents occur.

### Pesticide Storage

The label will tell you how to store the product. The storage area should keep the pesticides dry, cool, and out of direct sunlight, in a locked and posted place. Children and other untrained persons should not be able to get to them. Some chemicals require protection from freezing.

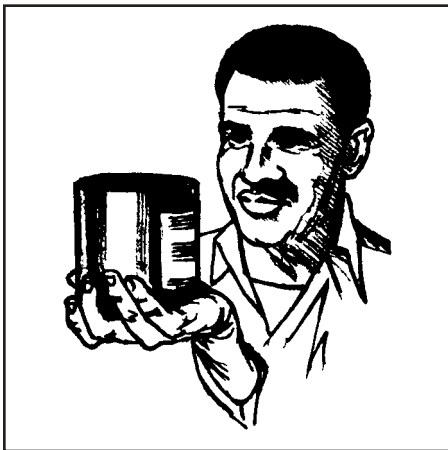

Read the label



An ideal storage place would have fire-resistant construction, including a concrete floor, an exhaust fan for ventilation, good lighting, and a lock on the door.

Keep the storage access locked when not in use.

The storage location should be away from where people and animals live to avoid or minimize harm to them in case of fire.

Store all pesticides in the original containers.

Do not store them near food, feed, seed, or animals.

Check every container often for leaks or breaks. If one is damaged, transfer the contents to a container that has held *exactly* the same pesticide. Clean up any spills correctly.

Keep an up-to-date inventory of the pesticides you have.

### Mixing and Loading Pesticides

Keep livestock, pets, and people out of the mixing and loading area.

Do not work alone, especially at night.

Work outdoors. Choose a place with good light and ventilation. Do not mix or load pesticides indoors or at night unless there is good lighting and ventilation.

Before handling a pesticide container, put on the correct protective clothing and equipment.

*Each time* you use a pesticide, read the directions for mixing. Do this before you open the container. *This is essential.* Directions, including amounts and methods, are often changed, and it is a violation of State and Federal laws to use a pesticide in a manner inconsistent with its label.

Do not tear paper containers to open them. Use a sharp knife. Clean the knife afterwards, and do not use it for other purposes.

When taking a pesticide out of the container, keep the container and pesticide below eye level. This will avoid a splash or spill on your goggles or protective clothing. Do the same thing when pouring or dumping any pesticide.

*If you splash or spill a pesticide while mixing or loading, stop right away.*

Remove contaminated clothing and wash thoroughly with detergent and water. *Speed is essential.* Clean up the spill.

When mixing pesticides, measure carefully. Use only the amount called for on the label. Mix only the amount you plan to use.

When loading pesticides, stand so the wind blows across your body (from the right or left) to avoid contaminating yourself.

To prevent spills, replace all pour caps and close containers after use.

### Mixing/Loading Facilities

Recent regulations have been introduced outlining new requirements for load/mix/storage facility requirements for commercial operations. At the present time, farmers are exempted from the rules. However, large farm operations may fall under the rules at a later date. The facility requirements are similar to those presently required for fertilizer facilities where quantity used exceeds the threshold limits (generally  $\geq 2000$  Gal storage or when 125 tons liquid or 25 tons dry material used during any 365 day period).

When possible, load and mix at several locations at the field site to avoid accumulation of materials in any one location. Field rinse all equipment and apply rinsate back to the field being treated. If not possible due to your operation configuration, use common sense housekeeping procedures around your mix/load area to prevent contamination or environmental damage. Store all pesticides according to label recommendations and in a location separated from fertilizers, feed or access by unauthorized personnel.

Additional load/mix/storage facility information may be obtained by requesting Designing Facilities for Pesticide and Fertilizer Containment, MWPS-37, available from your local County Extension Agent or Extension Agricultural Engineering at Kansas State University.

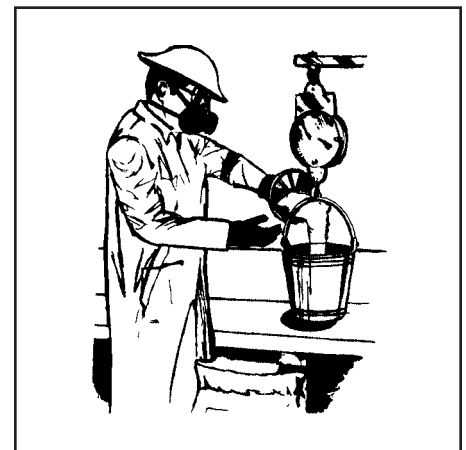

Mixing and Loading Pesticides



## Labels and

## Labeling

### Pesticide Application

Wear the correct protective clothing and equipment.

To prevent spillage of chemicals, check all application equipment for leaking hoses, pumps, or connections, and plugged, worn, or dripping nozzles.

Use water to correctly calibrate spray equipment before use. Before starting a field application, clear all people from the area to be treated.

**Drift** is the movement of spray droplets or dust particles away from the target area. Drift increases as droplet or particle size decreases, and as wind speed increases. It can be minimized if you select the proper equipment for the job, spray at low pressure, use the largest practical nozzle openings, and spray during the calmer times of the day.

**Vaporization** is the evaporation of an active ingredient during or after application. Pesticide vapors can cause injury far from the site of application. High temperatures increase vaporization. You can reduce vaporization by choosing nonvolatile chemical formulations, and spraying in the cooler parts of the day.

### Cleaning Equipment

Mixing, loading, and application equipment must be cleaned as soon as you finish using it. Use water and a detergent to clean both the inside and outside, including nozzles. Use extreme caution and avoid fumes if using pressure cleaners. Steam cleaners are not recommended for use on pesticide containers.

When possible, pesticide application equipment must be cleaned in the field to avoid concentration in one location. **NEVER clean equipment near any well.**

Equipment sometimes must be repaired before it is completely cleaned. Warn the person doing the repairs of the possible hazards.

### Disposal

The following procedures allow individuals using a pesticide at their private residences or farms to properly dispose of any pesticide wastes as required by Kansas law. Failure to do so can result in civil and criminal penalties. Assistance can be obtained from a field representative of the Kansas Department of Health and Environment (KDHE) who may be contacted through the Topeka office, phone no. 785-296-1600 or the Kansas Department of Agriculture (KDA), Pesticide & Fertilizer Program, phone no. 785-296-3786.

**Kinds of Pesticide Wastes**—The are three kinds of wastes which can originate from the use of a pesticide; (1) left-over or unused pesticides, (2) empty containers, and (3) the rinse solutions obtained by rinsing of a pesticide container or applicator device.

#### 1. Pesticides (left-over or unused)

The best way to solve the problem of pesticide waste disposal is to simply avoid producing any. Excess pesticides should be properly collected, labeled and temporarily stored for use in another spray mixture. Pesticide inventories should be carefully managed so that old or useless pesticide products do not accumulate. All pesticides or pesticide solutions should be stored according to label directions.

#### 2. Containers

Do not leave pesticides or pesticide containers at the application site. Do not reuse pesticide containers for any other purpose and do not allow children to play with pesticide containers. Leftover pesticides should be kept in tightly closed containers in your storage facility.

Always triple rinse or pressure rinse empty containers of liquid pesticides.

For **triple rinse**, follow this procedure:

1. Empty the container into the tank. Let it drain an extra 30 seconds.

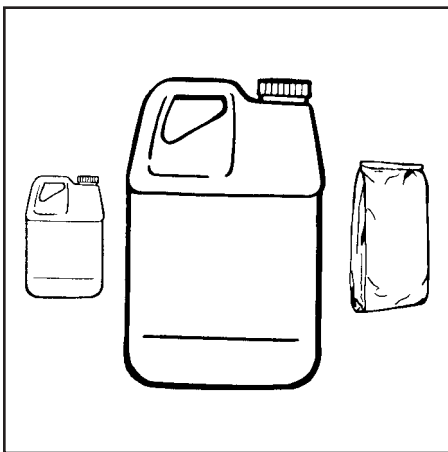

Containers

2. Immediately begin rinsing procedures or the product may become difficult to remove.
  3. Fill it one-fifth to one-fourth full of water.
  4. Replace the closure and shake the contents to rinse all inside surfaces.
  5. Drain the rinse water from the container into the tank. Let the container drain for 30 seconds.
  6. Repeat steps 3 through 5 at least two more times for a total of three rinses. Remember to empty each rinse solution into the tank.
- Be sure closure threads and outside of container are also clean.

For **pressure rinse**, follow this procedure:

1. Follow steps 1 and 2 listed above.
2. Hold the container so the opening can drain into the spray tank.
3. Force the tip of the special pressure nozzle through the lower portion of the side closest to the handle.
4. Connect the nozzle to a clean water source of at least 40 psi. Rotate the nozzle inside the container to assure good coverage of all sides, including the handle.
5. Rinse for at least 30 seconds.
6. Drain all rinse water into the spray tank.

### **Burnable Paper Containers**

- You may burn small numbers of them if permitted by state and local regulations unless prohibited by the label.
- You may take them to a landfill operating under state permit for pesticide disposal.
- Burning of plastic containers made of petroleum-based products is prohibited.

### **Nonburnable Containers (metal, plastic, or glass)**

- Rinse the containers three times.
- Many large containers in good shape can be recycled by your supplier. Return them to your supplier, a pesticide manufacturer or formulator, or a drum reconditioner.
- Some counties and commercial pesticide dealers will accept clean, high-density polyethylene containers for chipping and recycling. Contact your county extension agent or county noxious weed director for details.
- You can send or take them to a place that will recycle them as scrap metal or dispose of them for you.
- Properly rinsed containers may be crushed and buried in a sanitary landfill. Follow state and local standards.
- If it is not possible to rinse containers, contact the Department of Health and Environment for assistance.

### **3. Rinse Solutions**

*Reuse all rinse solutions* if possible. Otherwise, each rinse solution should be sprayed or uniformly spread over a preselected ground surface which is listed as a target site on the label and which is at least 100 feet from any water source such as a stream, pond, or well. Damage to vegetation should also be avoided. Make sure that rinse solutions do not contain amounts of active ingredient that will approach labeled rates.



# EXPRESS®

## HERBICIDE

### DRY FLOWABLE

**ACTIVE INGREDIENT****BY WEIGHT**

Methyl 2-[[[N-(4-methoxy-6-methyl-1,3,5-triazin-2-yl)  
methylamino]carbonyl]amino]sulfonyl]benzoate ..... 75%

**INERT INGREDIENTS** ..... 25%

TOTAL ..... 100%

EPA Reg. No. 352-509

U.S. Patents 4,383,113 & 4,740,234

**KEEP OUT OF REACH OF CHILDREN**

## CAUTION

### PRECAUTIONARY STATEMENTS

#### HAZARDS TO HUMANS AND DOMESTIC ANIMALS

**CAUTION!** Avoid contact with skin, eyes and clothing. In case of contact with eyes, immediately flush with plenty of water. Get medical attention if irritation persists. Wash thoroughly after handling.

**For medical emergencies involving this product, call toll free 1-800-441-3637.**

#### PERSONAL PROTECTIVE EQUIPMENT

**Applicators and other handlers must wear:**

Long-sleeve shirt and long pants.

Waterproof gloves.

Shoes plus socks.

Follow manufacturer's instructions for cleaning/maintaining PPE. If no such instructions for washables, use detergent and hot water. Keep and wash PPE separately from other laundry.

#### USER SAFETY RECOMMENDATIONS

**USERS SHOULD:** Wash hands before eating, drinking, chewing gum, using tobacco or using the toilet.

#### ENVIRONMENTAL HAZARDS

Do not apply directly to water, or to areas where surface water is present, or to intertidal areas below the mean high water mark. Do not contaminate water when disposing of equipment washwaters.

#### IMPORTANT INFORMATION - (READ BEFORE USING)

Injury to or loss of desirable trees or vegetation may result from failure to observe the following: Do not apply or drain or flush equipment on or near desirable trees or other plants, or on areas where their roots may extend, or in locations where the chemical may be washed or moved into contact with their roots. Do not use on lawns, walks, driveways, tennis courts or similar areas. Prevent drift of spray to desirable plants. Do not contaminate any body of water. Carefully observe all sprayer cleanup instructions both prior to and after using this product, as spray tank residue may damage crops other than wheat or barley.

## PESTICIDE HANDLING

- Calibrate sprayers only with clean water away from the well site.
- Make scheduled checks of spray equipment.
- Assure accurate measurement of pesticides by all operation employees.
- Mix only enough product for the job at hand.
- Avoid over-filling of spray tank.
- Do not discharge excess material on the soil at a single spot in the field/grove or mixing/loading station.
- Dilute and agitate excess solution and apply at labeled rates/uses.
- Avoid storage of pesticides near well sites.
- When triple rinsing the pesticide container, be sure to add the rinsate to the spray mix.

## GENERAL INFORMATION

Du Pont "Express" Herbicide is recommended for selective postemergence control of certain broadleaf weeds in wheat (including durum) and barley. Do not use "Express" on any other crop. "Express" is a dry flowable granule to be mixed in water or other recommended carrier and applied as a uniform broadcast spray. It is noncorrosive, nonflammable, nonvolatile and does not freeze.

Best results are obtained when "Express" is applied to young, actively growing weeds. The use rate will depend on weed spectrum and size of weed at time of application. The degree of control and duration of effect are dependent on rate used, sensitivity and size of target weed and environmental conditions at the time of and following application.

"Express" stops growth of susceptible weeds rapidly. However, typical symptoms of dying weeds (discoloration) may not be noticeable for 1-3 weeks after application (2-5 weeks for wild garlic) depending on the environmental conditions and weed susceptibility. Warm, moist conditions following treatment promote the activity of "Express", while cold, dry conditions delay the activity. Weeds hardened-off by cold weather or drought stress will be less susceptible.

A vigorous growing crop will aid weed control by shading and providing competition for weeds. However, a dense crop canopy at time of application can intercept spray and result in reduced weed control. Weeds may not be adequately controlled in areas of thin crop stand or seeding skips.

## INFORMATION ON RESISTANT WEEDS

Naturally-occurring weed biotypes\* that are resistant to Du Pont Ally<sup>®</sup> Herbicide, Dupont Finesse<sup>®</sup> Herbicide, Du Pont Glean<sup>®</sup> FC Herbicide or Du Pont Harmony<sup>®</sup> Extra Herbicide will also be resistant to "Express". In areas where these weed biotypes are known to exist, only spray "Express" in tank mixtures with other broadleaf herbicides having a different mode of action\*\* such as: 2,4-D, Banvel[1]/"Banvel" SGF\*\*\*, Buctril[2], Bronate[2], Curtail[3], Curtail M[3] MCPA or Du Pont "Lexone" DF Herbicide. Refer to TANK MIXTURES.

Note: Because these resistant biotypes are known to be present, accurate record keeping of pesticides applied to

individual fields is advisable in order to obtain information on the dispersal and spread of the resistant biotypes.

\* Biotypes are naturally-occurring individuals of the species which have a slightly different genetic makeup. Resistant biotypes may look exactly the same as susceptible biotypes. Herbicide-resistant biotypes are able to survive a use rate several times higher than needed to control susceptible biotypes.

\*\* Mode of action is the chemical interaction that interrupts a biological process necessary for plant growth and development.

\*\*\* Tank mixes with "Banvel"/"Banvel" SGF may result in reduced control of some broadleaf weeds.

Read and follow all appropriate sections of label, including precautions, before using this product.

## GRAZING

Do not graze or feed forage or hay from treated areas to livestock (harvested straw may be used for bedding and/or feed).

## DIRECTIONS FOR USE

It is a violation of federal law to use this product in a manner inconsistent with its labeling.

Do not apply this product in a way that will contact workers or other persons, either directly or through drift. Only protected handlers may be in the area during application. For any requirements specific to your State or Tribe, consult the agency responsible for pesticide regulation.

### AGRICULTURAL USE REQUIREMENTS

Use this product only in accordance with its labeling and with the Worker Protection Standard, 40 CFR part 170. This Standard contains requirements for the protection of agricultural workers on farms, forests, nurseries, and greenhouses, and handlers of agricultural pesticides. It contains requirements for training, decontamination, notification, and emergency assistance. It also contains specific instructions and exceptions pertaining to the statements on this label about personal protective equipment (PPE) and restricted-entry interval. The requirements in this box only apply to uses of this product that are covered by the Worker Protection Standard.

Do not enter or allow worker entry into treated areas during the restricted entry interval (REI) of 12 hours.

PPE required for early entry to treated areas that is permitted under the Worker Protection Standard and that involves contact with anything that has been treated, such as plants, soil, or water, is:

- Coveralls.
- Waterproof gloves.
- Shoes plus socks.

Do not apply this product through any type of irrigation system.

"Express" Herbicide should be used only in accordance with recommendations on this label or in separately published Du Pont recommendations.

Du Pont will not be responsible for losses or damages resulting from the use of this product in any manner not specifically recommended by Du Pont.

Do not use this product in the following counties of Colorado: Alamosa, Conejos, Costilla, Rio Grande and Saguache.

## **WEED CONTROL IN WHEAT AND BARLEY CROP STAGE AT APPLICATION**

Make applications after the crop is in the 2-leaf stage, but before the flag leaf is visible. Do not harvest sooner than 45 days after the last application of "Express".

### **APPLICATION RATES**

Apply 1/6 to 1/3 ounce "Express" per acre to wheat (including durum) or barley for control or partial control of the weeds listed below.

Use 1/3 ounce "Express" per acre when weed infestation is heavy and predominately consists of those weeds listed under partial control, or when application timing and environmental conditions are marginal (refer to APPLICATION AND ENVIRONMENTAL CONDITIONS FOR OPTIMUM PERFORMANCE).

Use 1/6 to 1/4 ounce "Express" per acre when weed infestation is light and predominately consists of those weeds listed under weeds controlled, and when optimum application conditions occur.

Sequential treatments of "Express" may be made provided the total amount of "Express" applied to the crop does not exceed 1/3 ounce per acre; for example, 1/6 ounce followed by 1/6 ounce. The final application must be made before the flag leaf is visible. Do not harvest sooner than 45 days after the last application of "Express".

### **WEEDS CONTROLLED**

Black mustard	Hairy buttercup
Blue/Purple mustard	Kochia
Bushy wallflower	Mayweed chamomile
/Treacle mustard	Miners lettuce
Coast fiddleneck	Pineappleweed
Common chickweed	Prickly lettuce
Common groundsel	Russian thistle
Common lambsquarters	Slimleaf lambsquarters
Corn spurry	Tarweed fiddleneck
False chamomile	Wild chamomile
Field pennycress	Wild mustard
Flixweed	

### **PARTIAL CONTROL \***

Annual sowthistle	Redroot pigweed
Canada thistle**	Shepherd's-purse
Common sunflower	Tansymustard
Hairy nightshade	Tumble/Jim Hill mustard
Henbit	Vetch** (common, hairy)
Pennsylvania smartweed	Wild buckwheat
Prostrate knotweed	Wild garlic**
Redmaids	Wild radish**

\* Partial control: A visual reduction of weed population as well as a significant loss of vigor for individual weed plants. For better results, use 1/4 to 1/3 ounce "Express" per acre and include a tank mix partner such as 2,4-D, MCPA, "Buctril" or "Banvel"/"Banvel" SGF (refer to TANK MIXTURES).

\*\*See SPECIFIC WEED PROBLEMS for more information.

### **SPECIFIC WEED PROBLEMS**

**Canada thistle:** For best results apply 1/3 oz. per acre plus surfactant in the spring when all thistles have emerged above the soil, are actively growing, and are 4 to 8 inches tall with 2 to 6 inches of new growth.

**Vetch (common and hairy):** For best results, apply 1/4 to 1/3 ounce of "Express" per acre plus surfactant when vetch is less than 6 inches in length. For severe infestations of vetch or when vetch is greater than 6 inches in length, "Express" should be applied in combination with 2,4-D or MCPA (refer to TANK MIXTURES).

**Wild garlic:** For best results, apply 1/3 ounce, "Express" per acre plus surfactant when wild garlic plants are less than 12 inches tall with 2 to 4 inches of new growth. Control may be reduced when plants are hardened-off by cold weather and/or drought stress. Control is enhanced when applications are made during warm temperatures to actively growing wild garlic plants. Typical symptoms of dying wild garlic plants (discoloration and collapse) may not be noticeable for 2-5 weeks.

Thorough spray coverage of all garlic plants is essential.

**Wild radish:** For best results, apply 1/3 ounce "Express" per acre plus surfactant either in the fall or spring to wild radish rosettes less than 6 inches in diameters. Applications made later than 30 days after weed emergence will result in partial control. Fall applications should be made prior to hardening-off of plants.

**Note:** If resistant weed biotypes, such as kochia and Russian thistle, are suspected (land which has had 2 or more previous applications of "Glean"/"Glean" FC or is immediately adjacent to land where "Glean"/"Glean" FC has been used 2 or more times) or known to be present, consider using another herbicide treatment or adjust the use rate of the "Express" tank mix partner labeled for the control of kochia and/or Russian thistle so that it alone will control the resistant biotypes.

### **APPLICATION AND ENVIRONMENTAL CONDITIONS FOR OPTIMUM PERFORMANCE**

**Crop Safety:** Many environmental, cultural practices, soil conditions and crop variety factors can cause stress to a crop. A pesticide application to a stressed crop may increase the chance for injury. To lessen the chance of crop injury under such conditions, tank mix "Express" with 2,4-D (ester formulations perform best) and apply after the crop is in the tillering stage of growth.

**Crop Stage:** Make applications after the crop is in the 2-leaf stage, but before the flag leaf is visible. Do not harvest sooner than 45 days after the last application of "Express".

Since thorough coverage is required, avoid crop canopy obstruction of the spray contacting the weed foliage.



**Crop Competition:** A vigorous growing crop will aid weed control by shading and providing competition for weeds. However, a dense crop canopy at time of application can intercept spray and result in reduced weed control. Weeds may not be adequately controlled in areas of thin crop stand or seeding skips.

**Pest Stage:** Since “Express” has very little or no soil activity, only those weeds that have germinated above the soil surface will be controlled. Consequently, application of “Express” should be made when all or the majority of weeds have germinated. Annual broadleaf weeds should be past the cotyledon stage, actively growing, and less than 4 inches tall or across. Wild garlic plants should be 6 to 12 inches tall with 4 to 6 inches of new growth. See SPECIFIC WEED PROBLEMS for more information on Canada thistle, vetch (common, hairy), wild garlic and wild radish.

Application: Foliar absorption is the primary means of “Express” uptake by plants; therefore, thorough spray coverage of weeds is essential.

**Weather:** Conditions which are conducive to healthy, actively growing plants optimize “Express” weed control performance. Ideal conditions include warm temperatures and adequate soil moisture before, during and immediately after application.

Avoid making applications of “Express” to weeds when rainfall is threatening. Rainfall immediately after treatment can wash “Express” off weed foliage and result in reduced weed control effectiveness. Several hours of dry weather are needed to allow “Express” to be absorbed by weed foliage.

**Surfactant:** Use only EPA approved surfactants authorized for use on food crops.

**Water Spray Carrier** - Unless specified otherwise, add a nonionic surfactant of at least 80% active ingredient strength at 0.25% vol/vol (1 quart per 100 gallons of spray solution).

**Liquid N Carrier** - Surfactant use is recommended when applying “Express” in liquid nitrogen fertilizer. When “Express” is applied using liquid nitrogen fertilizer solution as a spray carrier, early, temporary, crop yellowing and stunting may occur. These symptoms will be more noticeable when surfactant is used. Use 0.06 - 0.25% vol/vol surfactant (1/2 pint - 1 quart per 100 gallons of spray solution) when applying “Express” in liquid nitrogen fertilizer solution. Refer to TANK MIXTURES for surfactant information when tank mixing with other products. If surfactant is not used when applying “Express” in liquid nitrogen fertilizer, weed control may be significantly reduced.

## **EQUIPMENT-SPRAY VOLUMES**

It is important that spray equipment is cleaned and free of existing pesticide deposits before using “Express”. Follow the cleanup procedures specified on the label of the product previously sprayed. If no procedure is provided, follow this cleanup procedure for all application equipment.

1. Thoroughly rinse sprayer, tanks, boom, and hoses with clean water. Loosen and physically remove any visible deposits.

2. Partially fill the tank with water and add ammonia (1 gallon of 3% (household) ammonia per 100-gallons of tank volume) or a tank cleaner\* (follow individual label instructions for amount of tank cleaner to use). Complete filling the tank and flush the cleaning solution through the boom and hoses. Let stand for 15 minutes with agitation/recirculation and then drain the tank after flushing the hoses, boom and nozzles.
3. Thoroughly rinse sprayer, tanks, boom, and hoses with clean water.
4. Follow label directions of the product previously sprayed for rinsate disposal.

\* See listing of Du Pont approved tank cleaners under SPRAYER CLEANUP section of the label.

**NOTE:** A steam cleaning of aerial spray tanks is recommended to dislodge any visible pesticide deposits.

**Spray Equipment:** Refer to specific manufacturer’s recommendations for additional information on GPA, pressure, speed, nozzle types and arrangements, nozzle heights above the target canopy, etc., for respective application equipment.

Apply using properly calibrated air or ground equipment. Select a spray volume and delivery system that will insure thorough coverage and a uniform spray pattern. Avoid overlapping (unless otherwise specified), and shut off spray booms while starting, turning, slowing or stopping, or injury to the crop may result.

Do not use equipment and/or spray volumes that will cause spray to drift onto nontarget sites. Do not make applications during weather conditions which cause spray to drift onto nontarget sites. For additional information, refer to CAUTION - AVOID SPRAY DRIFT section of label.

Do not apply this product through any type of irrigation system.

**Ground Application:** For optimum spray distribution and thorough coverage, use flat fan or low volume flood nozzles. For flat fan nozzles, do not use less than 5 gallon spray volume per acre (GPA).

For flood nozzles on 30-inch spacing, use not less than 10 GPA and no larger than TK 10 or equivalent and not less than 30 psi. On 40-inch nozzle spacings, use not less than 13 GPA or not less than 20 GPA when nozzles are on a 60-inch spacing. 100% overlapping of nozzle spray pattern is essential for 30, 40 and 60-inch spacings.

When using liquid nitrogen solution as a spray carrier, for flood nozzles use not less than 30 GPA and no larger than TK20. See statements on liquid N solutions below for additional information.

Raindrop[4] nozzles are not recommended for “Express” applications as weed control performance may be reduced.

Use 50-mesh screens or larger.

**Aerial Application:** Use orifice discs, cores and nozzle types and arrangements that will provide for optimum spray distribution and maximum coverage at 1 to 5 GPA. Do not use less than 3 GPA in ID, OR, UT or WA. Do not apply during inversion conditions, when winds are gusty, or when other conditions will favor poor coverage and/or off-target spray movement.

For aerial application in the state of Washington, refer to and follow the directions on the Washington Special Local Need label, “Express” Herbicide Aerial Application to Wheat and Barley in the State of Washington.

**Liquid Nitrogen Fertilizer Solutions:** “Express” can be added directly to liquid N solutions (for example 28-0-0, 32-0-0). Surfactant use is recommended when applying “Express” in liquid nitrogen fertilizer. If surfactant is not used, weed control may be significantly reduced. When “Express” is applied using liquid nitrogen fertilizer solution as a carrier, early, temporary crop yellowing and stunting may occur. The symptoms will be more noticeable when surfactant is used. Use 0.06 - 0.25% vol/vol surfactant (1/2 pint - 1 quart per 100 gallons of spray solution) when applying “Express” in liquid nitrogen fertilizer solution.

The addition of liquid nitrogen fertilizer to the spray solution, or the use of liquid nitrogen fertilizer as the total carrier of the spray solution will increase the weight of the spray solution as compared to water (see table below). Consequently, appropriate conversions of spray nozzles and/or pressure must be made in order to maintain proper spray volumes. Refer to the conversion chart below for guidance (taken from Spray Systems Company Catalog 39, page 2).

Influence of adding liquid 28% N fertilizer to spray solution weight per gallon:

Weight of <u>% of Spray Solution</u>			(Lbs/Gallon)
Water	28% N		
100	0		8.34
50	50		9.5
0	100		10.6

### **SPRAYING SYSTEMS CONVERSION CHART**

#### *SPRAYING SOLUTIONS OTHER THAN WATER NEW METHOD*

Since all the tabulations are based on spraying water, which weighs 8.34 lbs per USA gallon, conversion factors must be used when spraying solutions which are heavier or lighter than water. To determine the proper size nozzle for the solution to be sprayed, first multiply the desired GPM or GPA of solution by the water rate conversion factor. Then use the new converted GPM or GPA rate to select the proper size nozzle.

Example: 10 GPA (28%N) X 1.13 = 11.3 GPA (water)

Weight of Solution	Specific Gravity	Conversion Factors
7.0 lbs per gallon	0.84	0.92
8.0 lbs per gallon	0.96	0.98
8.34 lbs per gallon-Water	1.00	1.00
9.0 lbs per gallon	1.08	1.04
10.0 lbs per gallon	1.20	1.10
10.65 lbs per gallon-28% nitrogen	1.28	1.13
11.0 lbs per gallon	1.32	1.15
12.0 lbs per gallon	1.44	1.20
14.0 lbs per gallon	1.68	1.30

Published in Spraying Systems Company Catalog 39, page 2.

**Agitation:** Continuous agitation is required to keep “Express” in suspension.

### **CAUTION - AVOID SPRAY DRIFT**

Follow these practices to minimize drift.

Do not allow spray from either ground or aerial equipment to drift onto adjacent crops or land, as even small amounts can injure susceptible plants. When spraying near adjacent, sensitive crops or plants, do everything possible to reduce spray drift. This includes:

- o Stop spraying if wind speed becomes excessive. DO NOT SPRAY IF WIND SPEED IS 10 MPH OR GREATER. Spray drift can occur at wind speeds less than 10 MPH. If sensitive crops or plants are downwind, extreme caution must be used even in relatively low wind conditions! DO NOT SPRAY IF WINDS ARE GUSTY.
- o High temperatures, drought and low relative humidity increase the possibility of spray drift. EXTREME CAUTION MUST BE USED WHEN THESE CONDITIONS ARE PRESENT AND SENSITIVE CROPS OR PLANTS ARE NEARBY, REGARDLESS OF WIND SPEED.
- o Do not apply when a temperature inversion exists. An inversion is characterized by low air movement and an increase in air temperature with an increase in altitude. In humid regions, a fog or mist may form. An inversion may be detected by producing a smoke column and checking for a layering effect. Smoke-producing devices on aircraft are recommended. If not sure whether inversion conditions are present, consult with local weather services before making an application.
- o Postemergence grass herbicides (such as Avenge[5] and Assert[5]) are often applied using high pressure. When “Express” is tank mixed with these products, do not exceed 40 psi.
- o Drift from aerial or ground equipment may be further reduced by:
  1. Using large droplet size sprays to minimize drift. DO NOT APPLY WITH HOLLOW-CONE INSECTICIDE NOZZLES ON GROUND EQUIPMENT. Do not use nozzles that produce small droplets, such as Sprayfoil[6] or airblast-type nozzles. Nozzles should be oriented at an angle between straight down and straight back for ground applications.  
For aerial applications, orient nozzles straight back along the windstream using straight stream orifices (such as disk with no swirl plate). If using flood-type nozzles on aircraft, orient them so spray is produced in direction of the airstream. Use the lowest number of nozzles practical with the largest orifice size per nozzle to obtain minimum of 1 GPA. Application height should not exceed 1/2 length of wing span, to minimize drift potential. Boom length must not exceed 2/3 of wing span.
  2. Increasing volume of spray mix per acre (for example, minimum 5 GPA by air, 10 GPA by ground) by using higher flow-rate nozzles.
  3. Reducing pressure (PSI). DO NOT EXCEED 40 PSI when applying “Express”. (Vehicle speed must also be reduced to maintain spray mix volume per acre).

Consult manufacturer's catalogs for details on correct calibration.

4. Apply as close to target plants as possible while still maintaining a good spray pattern.

**NOTE:** Do not allow spray to drift onto adjacent crops, or onto agricultural land scheduled to be planted to crops other than wheat or barley, as injury to the crop may occur. Extreme care must be taken to prevent drift onto susceptible nontarget plants or nontarget land.

### **TANK MIXTURES**

2,4-D (amine or ester) or MCPA (amine or ester) - Use "Express" plus 1/8 to 3/8 lb active ingredient 2,4-D or MCPA (ester formulations have provided best results). Surfactant may be added at 0.125 - 0.25% vol/vol (1 to 2 pints per 100 gallons of spray volume); however, the addition of surfactant may increase the chance of crop injury. Use the 1 to 2 pint rate of surfactant with 1/8 lb active ingredient rate of 2,4-D or MCPA. Use the 1 pint rate of surfactant with 1/4 to 3/8 lb active ingredient of 2,4-D or MCPA. Higher rates of 2,4-D or MCPA may be used, but do not exceed highest rate allowed on the label.

Always mix "Express" in water prior to adding 2,4-D or MCPA. Always add surfactant last. Read and follow all label instructions on timing, precautions and warnings for these herbicides prior to using these tank mixtures.

"Express" may be tank mixed with other suitable registered herbicides (for example "Lexone" DF, "Banvel"/"Banvel" SGF, "Buctril", "Bronate") to control weeds listed in Partial Control Table or other weeds than those listed in the Weeds Controlled Table. Read and follow all manufacturer's label recommendations for the companion herbicide. If these recommendations conflict with this "Express" label, do not use as a tank mix with "Express".

"Express" will not control wild oats or other grasses. For wild oat control, "Express" can be tank mixed with "Avenge" or "Assert". When tank mixing "Express" and "Assert", ALWAYS include another broadleaf weed herbicide with a different mode of action, for example: 2,4-D ester, MCPA ester, "Buctril", or "Bronate". DO NOT tank mix with Hoelon[7] 3EC as grass weed control may be reduced.

Always mix "Express" in water PRIOR to adding other products, including surfactants. When mixing "Express" in liquid nitrogen fertilizer solutions (for example 28-0-0, 32-0-0), simply add the "Express" directly to the liquid fertilizer with the agitator running.

Refer to SPRAY PREPARATION for further information.

Tank mixes of "Express" plus "Banvel"/"Banvel" SGF may result in reduced control of some broadleaf weeds.

Tank mixes of "Express" plus metribuzin may result in reduced control of wild garlic.

"Express" may be tank mixed or used sequentially with insecticides registered for use on cereal grains. However, under certain conditions (drought stress, crop in 2-4 leaf stage), tank mixes or sequential applications of "Express" plus organophosphate insecticides (such as parathion) may produce temporary crop yellowing or, in severe cases, crop injury. Limit first use to a small area before treating large areas.

DO NOT USE "EXPRESS" PLUS MALATHION as crop injury will result.

The use of a "Express" plus Lorsban[3] tank mix is recommended only in the states of CO, ID, KS, NE, NM, OK, OR, TX, UT, WA and southeastern WY.

### **SPRAY PREPARATION, ADDITIVES, PRODUCT MEASUREMENT, SURFACTANT AND LIQUID NITROGEN FERTILIZER**

**Spray Preparation:** Mix the proper amount of "Express" into the necessary volume of water in the spray tank with the agitator running, then add the companion herbicide to the tank after all the "Express" is in suspension. ALWAYS MIX "EXPRESS" IN WATER FIRST, PRIOR TO ADDING OTHER PRODUCTS IN THE SAME SPRAY TANK.

Use the spray preparation of "Express" within 24 hours as product degradation may occur. If spray preparation is left standing, thoroughly agitate before reusing.

**Additives:** Do not use with spray tank additives that lower the pH of the spray solution below 3.0, as rapid product degradation can occur.

**Product Measurement:** The "Express" volumetric measuring cylinder is to be used as a guide, since the degree of accuracy varies by plus or minus 7.5%. For more precise measurement, use scales calibrated in ounces.

**Surfactant:** Unless specified otherwise, add a nonionic surfactant of at least 80% active ingredient strength at 0.25% vol/vol (1 quart per 100 gallons of spray solution). Use only EPA approved surfactants authorized for use on food crops. Antifoaming agents may be needed. Do not use liquid fertilizer as a substitute for a surfactant. Refer to TANK MIXTURES and EQUIPMENT - SPRAY VOLUMES for variations on surfactant rate.

**Liquid Nitrogen Fertilizer:** Liquid nitrogen fertilizer solutions such as 28-0-0 or 32-0-0, may be used as a carrier in place of water. To apply "Express" with liquid nitrogen fertilizer, simply add the "Express" directly to the liquid fertilizer with the agitator running (for at least 3 to 5 minutes). For fertilizer solutions that contain more than just nitrogen, for example 10-34-0, slurry the desired amount of "Express" in a clean bucket using water until a flowable mixture is produced. Add this slurry to the agitating spray tank of liquid nitrogen fertilizer solution. Thoroughly rinse all of the "Express" slurry into the spray tank. Do not use "Express" in liquid fertilizer solutions of less than pH 3.0. Run a tank mix compatibility test before mixing "Express" in fertilizer solution. If 2,4-D is included in "Express" and liquid fertilizer mixture, ester formulations are generally more compatible.

Use 0.06 - 0.25% vol/vol surfactant (1/2 pint - 1 quart per 100 gallons of spray solution) when applying "Express" in liquid nitrogen fertilizer solution.

Use of "Express" and a surfactant in liquid nitrogen fertilizer solutions may cause early, temporary crop injury (discoloration and stunting).

When the spray solution contains liquid nitrogen fertilizer, the weight per gallon of solution varies significantly from the weight of water (8.34 lbs per USA gallon).

Consequently, liquid nitrogen fertilizer spray solutions must

use the appropriate conversion in order to insure proper spray volume. See EQUIPMENT-SPRAY VOLUMES for further information.

## CROP ROTATION

Any crop may be planted 60 days after the application of "Express".

## SPRAYER CLEANUP

### AT THE END OF THE DAY

It is recommended that during periods when multiple loads of "Express" herbicide when applied, at the end of each day of spraying rinse the interior of the tank with fresh water, then partially fill the tank and flush the boom and hoses. This will prevent the buildup of dried pesticide deposits which can accumulate in the application equipment.

### AFTER SPRAYING "EXPRESS" AND BEFORE SPRAYING CROPS OTHER THAN WHEAT OR BARLEY

To avoid subsequent injury to desirable crops, thoroughly clean all mixing and spray equipment immediately following applications of "Express" as follows:

1. Drain tank; thoroughly rinse spray tanks, boom, and hoses with clean water. Loosen and physically remove any visible deposits.
2. Fill the tank with clean water and one gallon of household ammonia\* (contains 3% active) for every 100 gallons of water. Flush the hoses, boom and nozzles with the cleaning solution. Then add more water to completely fill the tank. Circulate the cleaning solution through the tank and hoses for at-least 15 minutes. Again flush the hoses, boom and nozzles with the cleaning solution and then drain the tank.
3. Remove the nozzles and screens and clean separately in a bucket containing cleaning agent and water.
4. Repeat step 2.
5. Rinse the tank, boom and hoses with clean water.
6. The rinsate may be disposed of on site or at an approved waste disposal facility.

\* Equivalent amounts of an alternate strength ammonia solution or a Du Pont approved cleaner (listed below) can be use in the cleanout procedure. Carefully read and follow the individual cleaner instructions.

Du Pont approved cleaners:

- Protank Cleaner-Manufactured for Cenex/Land O'Lakes Agronomy Co.
- Chem-Tank Cleaner & Neutralizer-Manufactured by Farmbelt Chemicals, Inc.
- Incide-Out[8]
- Nutra-Sol-Compounded for Thomas G. Kilfoil Co., Inc., San Bruno, CA
- Tank and Equipment Cleaner-Manufactured by Loveland Industries, Inc.,
- Tank-Aid -Manufactured for Combelt Chemical Company

## NOTES:

1. A steam cleaning of aerial spray tanks is recommended prior to performing the above cleanout procedure to facilitate the removal of any caked deposits.
2. When "Express" is tank mixed with other pesticides, all cleanout procedures should be examined and the most rigorous procedure should be followed.
3. In addition to this cleanout procedure, all precleanout guidelines on subsequently applied products should be followed as per the individual labels.
4. Where routine spraying practices include shared equipment frequently being switched between applications of "Express" and applications to sensitive crops during the same spray season, it is recommended a sprayer be dedicated to "Express" to further reduce the chance of crop injury.
5. Since the presence of tank-mix partners can interfere with the dispersion of "Express" when multiple tank loads of the same mix are being prepared, preslurry "Express" in a dedicated container of clean water prior to adding to the tank.

## PRECAUTIONS

The total rate of "Express" cannot exceed 1/3 ounce product per acre applied to any one crop during one growing season.

Do not harvest sooner than 45 days after the last application of "Express".

Do not graze or feed forage or hay from treated areas to livestock (harvested straw may be used for bedding and/or feed).

Do not plant to any crop other than wheat or barley for 60 days after application of "Express".

Varieties of wheat (including durum) and barley differ in their tolerance to herbicides. When using "Express" for the first time on a particular variety, limit initial use to one 10 oz canister. If no symptoms of crop injury occur within 14 days after treatment, balance of acreage can be treated.

Do not apply to wheat or barley that is stressed by severe winter, drought (including low levels of subsoil moisture), water-saturated soil, disease or insect damage as crop injury may result. Under certain conditions such as prolonged cool weather (daily high temperature less than 50 Deg.F.) or wide fluctuations in day/night temperatures just prior to or soon after treatment, temporary yellowing and/or crop stunting may occur. Risk of injury is greatest when crop is in the 2 to 5-leaf stage.

Do not apply to wheat or barley crops underseeded with another crop.

"Express" is only registered on wheat and barley. Do not use on any other crop.

For ground applications applied to weeds when dry, dusty field conditions exist, control of weeds in wheel track areas may be reduced.

Tank mix applications of "Express" plus "Assert" may cause temporary crop discoloration/stunting or injury when heavy rainfall occurs shortly after application.

## **STORAGE AND DISPOSAL**

**STORAGE:** Store product in original container only, away from other

pesticides, fertilizer, food or feed.

**PRODUCT DISPOSAL:** Do not contaminate water, food or feed by storage or disposal. Waste resulting from the use of this product may be disposed of on site or at an approved waste disposal facility.

**CONTAINER DISPOSAL:** Triple-rinse (or equivalent). Then offer for recycling or reconditioning, or puncture and dispose of in a sanitary landfill, or incineration, or, if allowed by state and local authorities, by burning. If burned, stay out of smoke.

**NOTICE TO BUYER:** Purchase of this material does not confer any rights under patents of countries outside of the United States.

## **NOTICE OF WARRANTY**

Du Pont warrants that this product conforms to the chemical description on the label thereof and is reasonably fit for purposes stated on such label only when used in accordance with directions under normal use conditions. It is impossible to eliminate all risks inherently associated with the use of this product. Crop injury, ineffectiveness, or other unintended consequences may result because of such factors as weather conditions, presence of other materials, or the manner of use or application, all of which are beyond the control of Du Pont. In no case shall Du Pont be liable for consequential, special or indirect damages resulting from the use or handling of this product. All such risks shall be assumed by the buyer. DU PONT MAKES NO WARRANTIES OF MERCHANTABILITY OR FITNESS FOR A PARTICULAR PURPOSE NOR ANY OTHER EXPRESS OR IMPLIED WARRANTY EXCEPT AS STATED ABOVE.

### ***Registered trademarks of:***

[1]Sandoz Crop Protection Corporation.

[2]Rhône - Poulenc Ag Company.

[3]The Dow Chemical Company.

[4]Delavan Corporation.

[5]American Cyanamid Company.

[6]D. AND W. INDUSTRIES.

[7]Hoechst-Roussel Agri-Vet Company.

[8]Precision Laboratories, Inc.

**AG-7668 9063 6/24/93**



# Protecting Your Body and the Environment

## Using Pesticides Safely

There are two good reasons for using pesticides safely:

1. to keep yourself and other people from being poisoned, and
2. to avoid harming the environment.

## Protecting Humans

Most pesticides can cause severe illness, or even death, if misused. But every registered pesticide can be used safely if you use it correctly.

Children under 10 are the victims of at least half of the accidental pesticide deaths in this country. If pesticides were always cared for correctly, children would never touch them.

Many accidental pesticide deaths are caused by eating or drinking the product. But some mixers, loaders, and applicators die or are injured when they breathe a pesticide vapor or get a pesticide on their skin. Repeated exposure to small amounts of some pesticides can cause sudden severe illness.

### Pesticide Exposure

Pesticide exposure is divided into two, time related, categories: ACUTE and CHRONIC.

**Acute exposure** is when the amount of pesticide getting on or in the body from a single exposure (eg. spill or splash) is great enough to cause signs and symptoms of poisoning. Onset of symptoms after exposure may range from almost immediately to 12 hours after termination of exposure depending on the particular pesticide involved.

**Chronic exposure** is when the amount of pesticide getting on or in the body is at such a low level (amount) that signs and symptoms (of acute poisoning) are not present. Chronic exposure takes place over a long period, month after month or year after year. The health effects of chronic exposure to pesticides are not

well known. The main reason for this unknown is that it may take 40 to 50 years of chronic exposure to result in a disease, e.g., some form of cancer, or other reaction such as allergic sensitization—the development of allergies to pesticides or chemicals used in the formulation of pesticides. A further complication is that we are chronically exposed to many other chemicals which, perhaps, cause the same symptoms.

Whether the exposure is acute or chronic, there are three routes of exposure. These are ORAL, DERMAL and RESPIRATORY.

**Oral exposure** may occur because of an accident, but it is more likely to be the result of carelessness. Blowing out a plugged nozzle with your mouth, smoking or eating without washing contaminated hands, or eating food that has been recently sprayed with a pesticide can result in oral exposure.

The acute oral LD<sub>50</sub> ratings shown below range from extremely toxic to slightly toxic. The probable lethal dose for a 150 pound adult varies from a few drops to more than 2 pounds.

**Dermal exposure** is skin contamination. It can occur anytime a pesticide is mixed, applied, or handled, and it is often undetected. Its seriousness depends upon:

1. the dermal toxicity of the material;
2. the rate of absorption through the skin;
3. the size of the skin area contaminated; and
4. the length of time the material is in contact with the skin.

**Table: Acute Oral LD<sub>50</sub> Ratings**

Acute oral LD <sub>50</sub>	Probable Lethal dose, 150 pound adult
5 .....	few drops
50 .....	1 teaspoonful
500 .....	2 tablespoonsful
1,500 .....	1 pound
5,000 .....	2 pounds

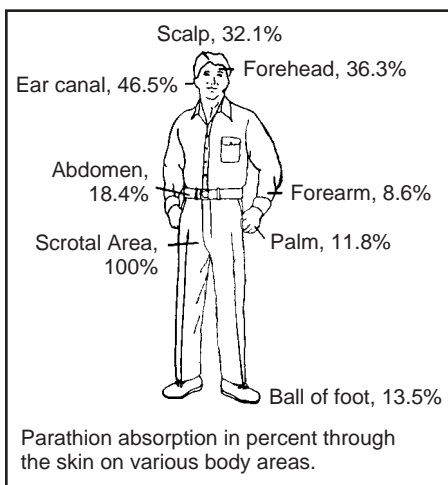

### Protective Clothing

---

## Protecting Your Body and the Environment

---

---

Dermal absorption is the most common route of exposure although the rate of absorption is higher for a given amount of chemical in the sensitive tissues of the respiratory and digestive tracts.

Rates of absorption through the skin are different for different parts of the body. The figure (on page 56) shows this variation.

The results show that parathion, for example, is absorbed at different rates on various areas of the body and that protective clothing must be worn to prevent skin exposure. Special care should be given to protect the scalp, ear canal and forehead. The abdominal area and belt (or waist) line should be protected to prevent chemical access to the scrotum and lightweight natural rubber gloves and boots should be worn to protect the hands and feet.

Absorption through the skin in the scrotal area is rapid enough to approximate the effect of injecting the pesticide directly into the bloodstream. At this rate, the absorption of pesticide through the skin into the bloodstream is more dangerous than swallowing it.

Absorption continues to take place through all the affected skin area as long as the pesticide is in contact with the skin. The seriousness of the exposure is increased if the contaminated area is large, or if the material remains on the skin for a long time.

**Respiratory exposure** results from breathing pesticide vapors, dust, or spray particles. Like oral and dermal exposure, inhalation exposure is more serious with some pesticides than with others.

Poisoning through the lungs is more common in confined areas such as greenhouses than it is outdoors because the pesticide is kept inside the structure. Poisoning can occur outdoors if the concentration of material is high or a highly volatile material is used.

Inhalation exposure can occur from the applicator smoking, breathing smoke from burning containers, breathing fumes from pesticides

while applying them without protective equipment, and inhaling fumes immediately after applying a pesticide. Fumigants produce toxic vapors and the primary means of exposure is by inhalation.

### Protecting Your Body

To prevent a pesticide from entering the body (through the skin, by swallowing it, or by inhaling it), you must wear protective clothing and use proper equipment. No safety recommendations can cover all situations. Your common sense should tell you to use more protection as the hazard increases. **The pesticide label will tell you the kind of protection you need.**

Remember to bathe, using a detergent, when you finish working with pesticides or pesticide-contaminated equipment. Any time you spill a pesticide on yourself, wash immediately.

### Protective Clothing

**Body Covering**—Any time you handle pesticides, you should wear at least a long-sleeved shirt and long-legged trousers, or a coverall-type garment, and shoes and socks.

They should be made of closely woven fabric. Fabric protectants, e.g., Scotch guard, can increase the repellent ability of the fabric to spills and splashes yet allow the fabric to breathe. However, retreatment of the fabric is necessary after two to three washings. When handling pesticide concentrates or very toxic materials, you also should wear a liquid-proof raincoat or apron. Wear trousers **outside** of the boots to keep pesticides from getting inside. Follow the label with regard to protective clothing requirements when working with all pesticides including fumigants.

**Hat**—Wear something to protect your head. A wide-brimmed, waterproof hat will protect your neck, eyes, mouth, and face. It should not have a cloth or leather sweatband. These sweatbands are hard to clean if chemicals get on them. Plastic "hard hats" with plastic sweatbands are good.

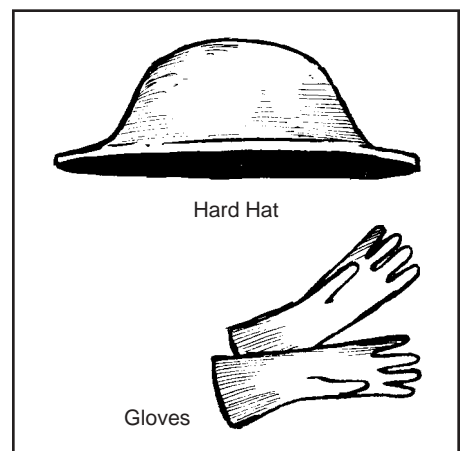
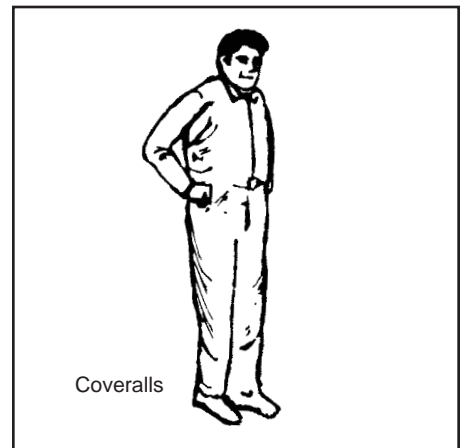

## Protecting Your Body and the Environment

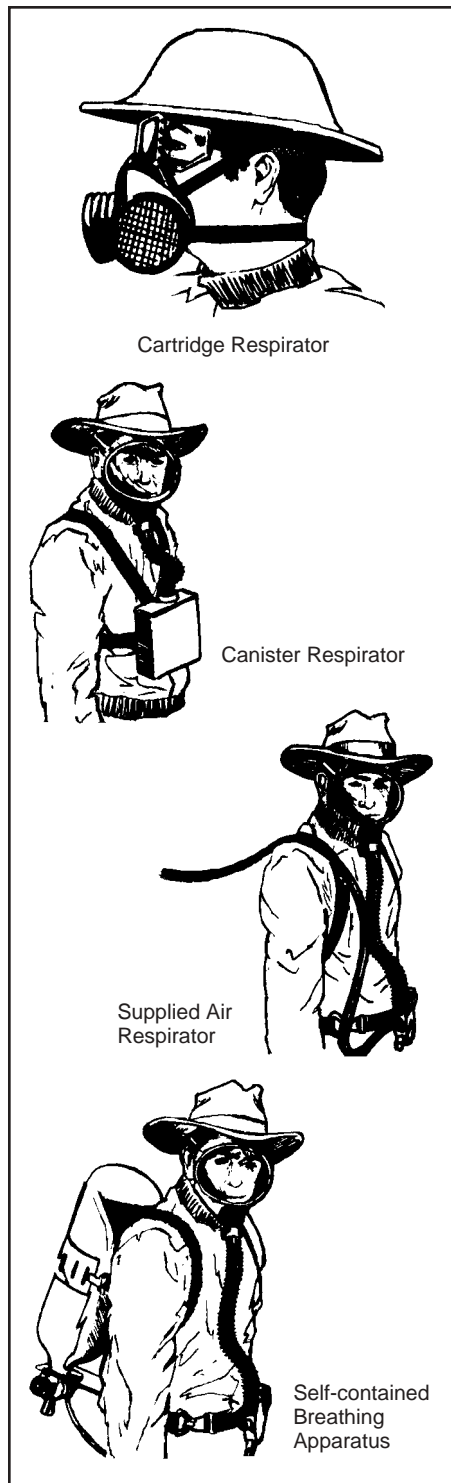

Respiratory Protective Devices

They are waterproof and are cool in hot weather.

**Boots**—Wear unlined neoprene boots except when applying fumigants. Check label instructions.

**Goggles or Face Shield**—Wear goggles or a face shield when there is any chance of getting pesticides in your eyes. Your eyes will absorb many pesticides. You can wear goggles alone or with a respirator.

**Care of Clothing**—Wear clean clothing daily. If clothes get wet with spray, change them right away. If they get wet with pesticide concentrates or highly toxic pesticides, destroy them. They can not be cleaned by normal methods. Protective clothing contaminated by fumigants should be thoroughly aired and then laundered. Do not store or wash contaminated clothing with the family laundry. Wash hats, gloves, and boots daily, inside and out. Hang them to dry. Test gloves for leaks by filling them with water and gently squeezing.

Wash goggles or face shields at least once a day. Elastic fabric headbands often absorb pesticides and are difficult to clean. Have some spares so you can replace them often, or use neoprene headbands.

### Respiratory Protective Devices

The respiratory tract—the lungs and other parts of the breathing system—is much more absorbent than the skin. You *must* wear an approved respiratory device when the label directs you to do so. Follow the label instructions on respiratory protection.

You probably will need a respirator if you will be exposed to a pesticide for a long time, if the pesticide you are using is highly toxic, or if you are working in an enclosed area.

**Chemical Cartridge Respirator**—You should wear this kind of respirator when you are exposed to intermittent concentrations of a toxic pesticide. Cartridge respirators will not protect you during fumigation or when the oxygen supply is low, as in a silo.

The inhaled air comes through both a filter pad and a cartridge made to absorb pesticide vapors. Most harmful vapors, gases, and particles are removed. The half-face masks cover the mouth and nose. To cover the eyes also, use one that is combined with goggles or wear separate goggles.

**Chemical Canister Respirator (Gas Mask)**—You should wear this kind of respirator when you are exposed to a continuous concentration of a toxic pesticide.

Canister-type gas masks usually protect the face better than cartridge types. Canisters have longer lasting absorbing materials and filters than cartridge respirators. Neither type respirator will protect you during abnormally high fumigant concentrations or when the oxygen supply is low. Fumigant labeling provides specific requirements for monitoring gas concentrations and respiratory protection for the various fumigants.

**Supplied Air Respirator**—You should use this kind of respirator when mixing or applying pesticides:

- when the oxygen supply is low, e.g., in a silo
- when you are exposed to high concentrations of highly toxic pesticides in enclosed areas, as in fumigation, e.g., in a grain bin, or
- when your work can be done close to a supply of clean air.

Clean air is pumped through a hose to the face mask.

**Self-Contained Breathing Apparatus**—You should wear this kind of respirator under the same conditions as the supplied air respirator. The difference is that you carry cylinders of air or oxygen with you, usually on your back. This lets you move more freely and over a wider area than you can with a supplied air respirator.

**Selection and Maintenance**—Specific types of cartridges and canisters protect against specific chemical gases and vapors. Be sure you choose one made for the pesticides you are using. Use only those approved by the National Institute for Occupational

Safety and Health (NIOSH), or the Mining Enforcement and Safety Administration (MESA).

The respirator must fit the face well. Long sideburns, a beard, or glasses may prevent a good seal. Read the manufacturer's instructions on the use and care of any respirator and its parts before you use it.

When applying pesticides, change filters, cartridges, and canisters if you have trouble breathing, or if you smell pesticides. Remove and discard filters, cartridges, and canisters after use as you would excess pesticides. Then wash the face piece with detergent and water, rinse it, and dry it with a clean cloth. Store it in a clean, dry place away from pesticides.

The useful life of a cartridge or canister depends on:

- the amount of absorbent material,
- the concentration of contaminants in the air,
- the breathing rate of the wearer, and
- the temperature and humidity.

As a rule of thumb, the cartridge should be changed after eight hours of use or unprotected exposure to the air (keep in a sealed plastic bag between uses) because there is no way of knowing when it will fail. Discard any canister that has been used for more than 30 minutes in a fumigant atmosphere.

### Worker Protection

Due to the newly revised Worker Protection Standard, personal protective equipment (PPE) requirements on labels will become more specific. Based on the toxicity of the product, long-sleeved shirts, coveralls, aprons, or other PPE may be required. It is more important than ever to carefully read the label to determine the PPE is required. For additional information, refer to the chapter on "Labels and Labeling" in this manual.

### Toxicity and Hazard

Pesticides are poisonous. They have to be poisonous to kill undesirable plants, insects, diseases, or other

pests. Safe and proper use of pesticides depends upon a knowledge of their toxic properties and a respect for the potential hazards associated with their use.

### Toxicity

Toxicity is the inherent capacity of a pesticide to produce injury or death. If you know the toxicity of a pesticide, you will know what precautions to take.

Tests are performed with each pesticide to determine the toxicity to rats, rabbits, guinea pigs, or other animals. These tests are helpful in determining how hazardous the pesticide probably would be to humans.

In oral tests, the animal is given quantities of the pesticide by mouth according to the animal's body weight. The dose is increased until the dose that will kill 50 percent of the test animals is found. This lethal dose is called "Oral LD<sub>50</sub>." The dose is expressed in milligrams per kilogram of body weight (mg/kg). The lower the LD<sub>50</sub> number, the more toxic the pesticide.

In dermal tests, the pesticide is placed on the skin of the test animal and covered with a bandage so that it will remain on the skin for 24 hours. If 100 milligrams of the pesticide are required to kill 5 out of 10 test animals weighing one kilogram, the Dermal LD<sub>50</sub> is 100.

In inhalation tests, the test animals are placed in an airtight container with specific quantities of the pesticide. The animals remain in the container for one hour. Inhalation values, called LC<sub>50</sub>s, are measured in micrograms per liter (ug/l). The LC<sub>50</sub> is the lethal concentration that will kill 50 percent of the test animals. LC<sub>50</sub> also refers to toxicities to fish in water, and is expressed in parts per million (ppm).

### Hazard

Hazard and toxicity are not the same. Hazard is a combination of toxicity and exposure. It is the potential

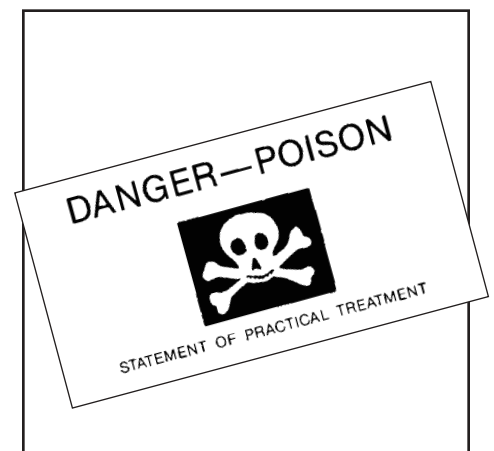



---

## Protecting Your

---

## Body and the

---

## Environment

---

threat that injury will result from the use of a pesticide in a particular formulation or quantity.

Some hazards do not involve toxicity to humans or other animals. For example; sulfur, oils, and numerous other chemicals are considered safe, or relatively safe, to animals but may cause considerable injury to some plants.

A compound may be extremely toxic but present little hazard when used:

1. in a very dilute formulation,
2. in a formulation that is not readily inhaled or absorbed through the skin,
3. only occasionally and under conditions in which humans are protected with protective equipment and clothing, and
4. only by knowledgeable applicators who are properly equipped to handle the chemical safely.

Conversely, a chemical may be relatively nontoxic but present a hazard because it is normally used in a concentrated form that may be readily absorbed or inhaled. Or it may be used by a nonprofessional, such as a home gardener, who is not aware of the possible hazards to which he is being exposed.

You should help prevent *all* accidents with pesticides by using and storing pesticides away from children and other untrained persons, and by taking care to follow directions when using them.

Products for restricted use need special care. The label is your guide.

### Cholinesterase Tests

Cholinesterase is an enzyme needed in the nervous system. Repeated exposure to the organophosphate and carbamate pesticides can lower this enzyme level and cause poisoning.

Persons who work with organophosphates or carbamates for an extended time during the year (farmers, pesticide applicators, pesticide manufacturers, formulators, etc.) should establish a regular cholinesterase testing program with their doctor. For a

farmer, such a program would likely consist of one (initial) cholinesterase test to determine his "base line level." This test should be done in the "off season" (e.g., January or February).

Then, when the pesticides are being used during the summer, similar tests are done on the individual and the results compared with the base line level of cholinesterase. Through this testing procedure, the pesticide user can be made aware of his cholinesterase level during the time of year when he is exposed to pesticides. When cholinesterase levels are depressed to a given level, the doctor may advise that the individual limit or possibly completely stop his exposure to these pesticides until the cholinesterase level returns toward "normal."

Doctors should arrange for their patients to have these tests and may obtain additional information through their state health department.

### Symptoms of Pesticide Poisoning

You should know what kinds of sickness are caused by the pesticides you use. You also should know the conditions under which each one may make you sick.

There are two kinds of clues to pesticide poisoning. Some are feelings that only the person who has been poisoned can notice—such as nausea or headache. These are *symptoms*. Others, like vomiting, also can be noticed by someone else. These are *signs*. Learn to recognize:

- what your own feelings might mean, and
- what signs of poisoning to look for in your co-workers and others who may have been exposed.

All pesticides in the same chemical group cause the same kind of sickness. This sickness may be mild or severe, depending on the pesticide and the amount absorbed. But the *pattern* of illness caused by one type of pesticide is always the same. Having some of the signs and symptoms does not



Doctor's Office



always mean you have been poisoned. Other kinds of sickness may cause similar signs and symptoms. Headache and a feeling of being unwell, for example, may signal the start of many kinds of illness. It is the *pattern of symptoms* that makes it possible to tell one kind of sickness from another. **Contact your doctor immediately if you or your co-worker have symptoms or signs of pesticide poisonings which occur after using a pesticide.** Take the label of the pesticide with you when you go to the doctor.

Most chemical manufacturers are equipped to provide emergency information on their products. Manufacturers may be contacted through CHEMTREC. **For help in a Chemical Emergency Involving a Spill, Leak, Fire, or Exposure, Call Day or Night CHEMTREC—(800) 424-9300 (TOLL FREE).**

## **Insecticides**

### **Organophosphates**

These pesticides affect the nervous system. The signs and symptoms go through stages. Some common examples are parathion, methyl parathion, Di-Syston, Phosdrin, Counter, Diazinon, Thimet, and malathion. They normally occur in this order:

#### **Mild Poisoning**

- fatigue,
- headache,
- dizziness,
- blurred vision,
- too much sweating and salivation,
- nausea and vomiting, and
- stomach cramps or diarrhea.

#### **Moderate Poisoning**

- unable to walk,
- weakness,
- chest discomfort,
- muscle twitches,
- constriction of pupil of the eye, and
- earlier symptoms become more severe.

#### **Severe Poisoning**

- unconsciousness,
- severe constriction of pupil of eye,

- muscle twitches,
- secretions from mouth and nose,
- breathing difficulty, and
- death if not treated.

Illness may be delayed a few hours. But if signs or symptoms start more than 12 hours after you were exposed to the pesticide, you probably have some other illness. Check with your physician to be sure.

### **Carbamates**

Carbamates act almost like organophosphates. They produce the same signs and symptoms. But the injury they cause can be corrected more easily by a physician. For this reason, most carbamates are safer than organophosphates. The label will warn you of the danger. Examples include, Temik, Furadan, Sevin, Vydate, and methomyl.

### **Organochlorines**

Not many organochlorines (chlorinated hydrocarbons) have poisoned applicators. Examples are endrin, aldrin, endosulfan (Thiodan), dieldrin, toxaphene, lindane, and chlordane. EPA has sharply curtailed use of many of these products.

Early signs and symptoms of poisoning include:

- headache.
- nausea,
- vomiting,
- general discomfort, and
- dizziness.

With more severe poisoning, convulsions follow. They may even appear without the warning symptoms. Coma may follow the convulsions. The person also may be unusually excited or irritable.

### **Pyrethroids**

Pyrethroid insecticides began entering the market place in the early 1980s and increased dramatically by the end of the decade. They are similar, in many respects, to the naturally occurring pyrethrins but are chemically modified to increase their stability under environmental use conditions.

---

## Protecting Your

---

### Body and the

---

### Environment

---

Pyrethroids are effective at very low use rates and are effective against a wide range of insect pests. In general, pyrethroids are low in toxicity to humans.

Extraordinary absorbed amounts (doses) of pyrethroids may cause:

- incoordination
- tremors
- salivation
- vomiting
- diarrhea, and
- irritability to sound and touch.

Extreme doses have caused convulsions in laboratory animals.

Examples of pyrethroids are fenvalerate (Pydrin, Ectrin), permethrin (Ambush, Pounce, Ectiban, Atroban), cypermethrin (Ammo, Cymbush, Demon, Ripcord), flucythrinate (Pay-off), fluvalinate (Mavrik), and cyfluthrin (Tempo).

## Fungicides

### Dithiocarbamates

This class of chemicals includes many fungicides, such as thiram, ferbam, maneb, and mancozeb. Although these chemicals are similar, they are metabolized differently by animals and effects on human health are also different. Thiram and ferbam irritate the skin and mucous membrane. Maneb and mancozeb degrade in the environment and in animal tissues to a compound that apparently causes cancer in laboratory animals.

Signs and symptoms depend on the chemical and route of exposure. Skin irritation may result from contact with thiram and ferbam. Swallowing large amounts of one of these pesticides may produce nausea, vomiting, and diarrhea. If excessive amounts of spray or dust are inhaled, maneb and mancozeb irritate the skin and cause itching, sneezing and coughing.

## Herbicides

### Phenoxy Compounds

Herbicides in this group include 2,4-D and 2,4-DB. Some of the phenoxy acids, salts, and esters are mod-

erately irritating to skin, eyes, and respiratory and stomach linings. These compounds are absorbed through the gut wall, lungs, and skin. Excretion in the urine occurs within hours, or at most, days.

The signs and symptoms of phenoxy compounds are moderately irritating to skin and mucous membranes. Inhalation of sprays may cause burning sensations in the chest and coughing may result. Swallowing of very large amounts has produced fever, hyperventilation and sweating.

### Thiocarbamates

This class of chemicals includes many herbicides. Herbicides of this group include butylate, vernolate, and EPTC.

Although these chemicals are similar, they are metabolized differently by animals and effects on human health are also different. Thiocarbamate herbicides do not appear to be highly toxic.

Signs and symptoms of thiocarbamates are moderate irritation to eyes and some irritate the skin and cause itching, sneezing and coughing.

### Paraquat and Diquat

Herbicides and products in this group include paraquat (Gramoxone Extra or Cyclone) and diquat (Diquat).

These chemicals injure the skin, nails, cornea, liver, kidney and linings of the gastrointestinal and respiratory tracts. Contact with the concentrate may cause irritation and fissuring of the skin of the hands, and cracking and sometimes loss of the fingernails. When absorbed by ingestion, paraquat damages the liver and kidney. Diquat appears less likely than paraquat to cause death.

Signs and symptoms for ingested paraquat are:

- pain,
- nausea,
- vomiting, and
- diarrhea.

For diquat ingestion

- intense nausea,
- vomiting, and
- diarrhea.

## Rodenticides

Rodenticides include both single-dose and multiple-dose toxicants. The multiple-dose rodenticides are primarily anticoagulant compounds that cause death through internal bleeding and organ damage following several days of consumption. Some of the newer anticoagulant compounds, however, can cause death after only a single dose.

The single-dose rodenticides include zinc phosphide, cholecalciferol (Quintox), strychnine, and the second generation anticoagulants brodifacoum (Havoc, Talon) and bromadiolone (Maki, Contrac).

The multiple-dose rodenticides include the hydroxycoumarins such as warfarin and fumarin; and the indandiones such as diphacinone (Ramik), chlorophacinone (RoZol) and Pival.

Signs and symptoms: very small amounts of the extremely toxic compound—zinc phosphide—can cause fatal poisoning. Strychnine is also extremely toxic, but human poisoning with this compound is rare because of its bitter taste. Havoc, Talon and the multiple-dose (anticoagulant) rodenticides present relatively less toxic hazard to humans and domestic animals.

## Inorganic Pesticides

Large single doses of most inorganic pesticides cause vomiting and stomach pain. The signs and symptoms depend on the mineral from which the pesticide is made.

## Plant-derived Pesticides

Some plant-derived pesticides are very toxic. Technical pyrethrum may cause allergic reactions. Some rotenone dusts irritate the respiratory tract. Nicotine is a fast-acting nerve poison about as dangerous as parathion.

Some other plant-derived pesticides are strychnine, rotenone, and red squill.

## Fumigants

Examples are phosphine (generated by aluminum or magnesium phosphide, e.g., Phostoxin, Detia, Fumitoxin, Gastoxin, Weevilcide), methyl bromide, and chloropicrin. Fumigants have the ability to penetrate lining membranes of the respiratory and gastrointestinal tracts and the skin. They may also penetrate or be absorbed by the rubber and/or plastics used in protective clothing but are not effectively taken up by the absorbents used in ordinary respirators. Inhaling is obviously the common route of absorption.

Signs and symptoms of fumigant exposure depend on the various chemicals. In general, respiratory tract irritation is the most common injury caused by fumigants.

### CHLOROPICRIN (tear gas):

#### *Acute symptoms*

- eye and respiratory irritation
- breathing difficulty, coughing
- nausea, vomiting
- weakness, rapid unconsciousness and death

*Chronic symptoms*—none known.

Severe burns can occur with prolonged skin contact.

### METHYL BROMIDE:

#### *Acute symptoms*

- headache
- nausea, vomiting
- staggers
- visual problems
- slurred speech
- convulsions and death

#### *Chronic symptoms*

- tremors (shakes)
- vision problems
- numbness of arms and legs
- speech problems
- mental confusion

Severe burns can occur with prolonged skin contact.

---

## Protecting Your

---

## Body and the

---

## Environment

---

### PHOSPHINE:

#### *Acute symptoms*

- headache
- giddiness
- faintness
- nausea
- discomfort in chest

#### *Chronic symptoms*—none known.

The severe irritation caused by chloropicrin makes it unlikely that exposed persons would voluntarily inhale sufficient gas to cause lung damage. Methyl bromide and phosphine are generally not irritating to the nose and throat but cause serious injury to the cells lining the fine air sacs of the lung and are more likely to cause lung damage. In varying degrees, fumigants depress the central nervous system and cause difficulty in breathing or total stoppage of breath resulting in death.

### Fumigation

Fumigation of farm stored grain has been dramatically changed by the EPA cancellation of traditional liquid grain fumigants and the enactment of new, stringent regulations governing usage of the remaining products.

The following total grain handling procedures are more important than ever:

- pre-harvest preparation of the bins, including cleaning, repairing, and application of residual sprays. Remember the first couple of bushels “scoured” out of the harvesting machinery may be infested from previous crops and should not be placed in storage.
- harvest operations, including properly adjusted harvest, and conveying equipment, visually checking incoming grain, use grain protectant sprays in incoming grain, and moisture sampling; and
- post harvest operations, including regular grain inspections for insects and spoilage; monitoring of grain temperatures at several locations within the mass; proper use of aeration; and fumigation if necessary.

Fumigation is the use of chemicals which volatilize to form toxic vapors or gases used to kill insect pests. These gases (fumigants) are also toxic to humans. Fumigants penetrate cracks, crevices, and the commodity being treated. They must be retained within a confined space (grain bin or under a gas tight sheet) at a toxic concentration for a minimum period of time to effectively kill the insects. Fumigants do not provide any residual protection, so reinfestation can occur immediately after the grain or other treated product has been “aired out” or the gas concentration falls below the lethal level. **READ AND FOLLOW ALL LABEL DIRECTIONS.**

Several factors can alter the effectiveness of fumigants. They include:

- temperature of the commodity,
- moisture of the grain,
- pest or pest complex present, and
- structure of the bin.

### Pre-Application

Fully understand the facility—bin or elevator—and its surroundings in preparation for fumigation. The following are *some* of the major considerations before fumigating.

- Can some other method of control be used? Is fumigation really the best method?
- Does the design and construction insure the gas-tightness of the structure being fumigated? What is the volume of the structure and amount of commodity to be fumigated?
- Are there connecting buildings or offices with persons or commodities that might be affected by the fumigant gases? Where will vented gases go when released?
- Have you selected the best fumigant for the job and **READ ALL LABEL DIRECTIONS.**
- Are you certified and properly trained in fumigation procedures and do you have all the required safety and gas detection equipment?

- Do you really want the liability that goes along with conducting the fumigation yourself? Commercial fumigators often guarantee their work and immediate re-treatment to correct a poor kill is often done at little or no additional cost to you. If you treat the grain or structure yourself there is no guarantee.

### Application

Everyone involved in the fumigation should be trained in fumigation procedures and be familiar with first aid and other emergency procedures.

#### **FUMIGANTS ARE RESTRICTED USE PESTICIDES.**

- Follow label directions exactly when applying a fumigant. Calculate the quantity needed and apply it according to label directions. Consider prevailing winds and other pertinent weather factors such as temperature and humidity.
- Monitor gas concentrations during the application to insure that allowable exposure levels are not exceeded.
- When applying a fumigant from inside the structure being fumigated (such as in a grain bin) two trained persons are required. At least one of the applicators must be certified (preferably both).
- Proper respiratory protection must be available to applicators.
- All fumigated areas should be posted with warning signs bearing the skull and crossbones and signal word DANGER and other required information i.e. name of person fumigating, type of fumigant, date of fumigation, etc. Entrances should be secured by locks or guards as appropriate.
- Be aware of any indications of illness or physical discomfort (dizziness, nausea, headache, or lack of coordination) no matter how minor they seem. Do not consume alcohol for 24 hours before or after fumigating.

### Post-Application

Before re-entry, a suitable gas detector (by law) must be used to determine whether gas concentrations are below hazardous levels. Wear correct respiratory protection when taking gas readings. Make a written record of all steps taken and gas concentrations observed for future reference.

#### **DO NOT DEPEND ON ODORS.**

Some fumigant gases are odorless.

- Turn on all ventilating or aerating fans.
- Check for gas concentrations in areas that are expected to aerate slowly.
- Remove warning signs when the gas concentration is within safe limits for human exposure.
- Remove and dispose of any packaging and waste products of solid fumigants according to label directions.

On those occasions when a fumigated area must be entered, a self contained breathing apparatus (SCAB) consisting of a tank of air and a full face mask must be worn when the concentration of gas is unknown or is above that safe for use of canister masks or for human exposure.

### Pesticide Accidents

If a pesticide spill or accident occurs, you should:

- get medical attention if there are any poisoned victims.
- give first aid to help a victim while help is on its way.
- rope off the area of the spill.
- call the chemical company who manufactured the product.

If the manufacturer is not known or several chemicals are involved, get as much information as you can, e.g., type of pesticide, location, type of accident, approximate amount of pesticide involved, and any other information which you think will aid in solving the problem, and call CHEMTREC, the National Agricultural Chemicals Association Pesticide Safety Team Network, 1-800-424-9300.



---

## Protecting Your

---

### Body and the

---

### Environment

---

- Notify the U.S. Environmental Protection Agency, 913-551-7030.
- Notify the Kansas Department of Agriculture (the state pesticide regulatory agency), 785-296-3786.
- Notify the Kansas Department of Health and Environment, 785-296-1600.
- Notify your county agent.

### Treatment of Pesticide Poisoning

First aid is the initial effort to help a victim while medical help is on the way. The first step in any poisoning emergency is to call an ambulance or doctor except when you are alone with the victim. Then you must make certain that the victim is breathing and is not further exposed before calling an ambulance or a doctor.

The label of the pesticide responsible for the poisoning should always be saved for the doctor. **FIRST AID DOES NOT REPLACE PROPER MEDICAL TREATMENT!**

While waiting for the ambulance or doctor, follow the proper first-aid procedures for poison on the skin, in the eyes, inhaled, or swallowed. These procedures are described below.

#### Poison on the Skin

Drench the victim's skin and clothing with water. The faster the poison is washed off, the less injury will result. In an emergency, use any source of fairly clean water, such as irrigation canals, lakes, ponds, or water troughs.

Wash a chemical burn area with large quantities of running water, and cover immediately with a clean, soft cloth. Do not use ointments, greases, powders, or drugs in first aid treatment of burns. Be careful not to get any pesticide on yourself while helping the victim.

#### Poison in the Eyes

It is most important to wash the eyes out as quickly but as gently as possible. Holding the victim's eyelids

open, wash his eyes with a gentle stream of clean, running water for 15 minutes or longer. Do not use chemicals or drugs in the wash water. They may increase the extent of the injury.

#### Inhaled Poison

If the victim is in an enclosed space, do not go in after him without an air-supplied respirator. Open all doors and windows. Carry the victim (do not let him walk) into the fresh air immediately. Loosen the victim's clothing. Apply artificial respiration if his breathing has stopped or is irregular, and keep him as quiet as possible.

If the victim is convulsing, watch his breathing and protect him from falling and striking his head. Keep his chin up so that his air passage will remain free for breathing. Prevent chilling. Wrap the victim in blankets but don't allow him to become overheated.

#### Swallowed Poison

The best first-aid treatment for a person who has swallowed a pesticide is to give him large amounts of plain water or milk. Give 1 to 2 cups for victims up to 5 years of age, and up to 1 quart for victims 5 years old and older.

Milk is preferable to water because it both dilutes and helps neutralize the poison. Water simply dilutes the poison. Diluting the poison will often be sufficient treatment until you can get the victim to a hospital.

In addition to diluting the poison with milk or water, give the victim one of the following *universal antidotes* to neutralize the effects of the poison.

**For acids only.** If you are sure that the poison is an acid, give the victim milk of magnesia (1 tablespoon to 1 cup of water), baking soda, or chalk in water.

**For alkali only.** If you are sure that the poison is an alkali, give the victim lemon juice or vinegar.

---

## Protecting Your

## Body and the

## Environment

---

---

*For concentrated petroleum products.* Dilute with milk or water *only*.

*Universal sponges* that absorb excess poisons are recommended where the type of poison swallowed is unknown. Activated charcoal (such as that used in aquarium filters) is a universal sponge that absorbs many poisons at a high rate. Mix it with water into a thick soup for the victim to drink. Grosafe, a commercial preparation of activated charcoal, is sold for use on pesticide spills or overdoses on crops and soil. In a poisoning emergency, this product may be substituted for a pharmaceutical grade of activated charcoal.

A homemade universal sponge for poison is a mixture of 4 tablespoons of toast (burnt black), 2 tablespoons of strong tea (instant tea mix can be used), and 2 tablespoons of milk of magnesia. This mixture will absorb and neutralize most poisons.

### Medical Antidotes

Medical antidotes are also available to neutralize the poisoning effects of other pesticides. Taken improperly, however, these antidotes can be more dangerous than the effects of the pesticide itself. Medical antidotes should be prescribed and given only by a physician. No known antidotes exist for some pesticides. Once a lethal dose has been ingested, the effects are irreversible and terminal.

**REMEMBER**—The pesticide label will contain directions on what to do in case of a poisoning. Read the directions in the **FIRST-AID** statement on each label. These instructions can save your life and the lives of your employees. Refer to the label *before* using the pesticide so that you may be prepared in case an emergency arises.

Poison Control Centers have been established at various locations in Kansas to provide pertinent information on all types of poisoning, including pesticide poisoning. Tell your doctor what pesticides you will be using. He can then determine the poi-

soning symptoms and appropriate treatment and have antidotes on hand if a poisoning should occur.

Get medical advice quickly if you or any of your fellow workers have unusual or unexplained symptoms while at work or later in the day. Do not allow yourself or anyone else to become dangerously ill before calling a doctor or going to a hospital. It is better to be too cautious than too late.

If you believe that you may have been poisoned, be sure to take the pesticide container (as labeled) to the doctor. Do not carry the pesticide container in the passenger space of a car or truck.

### Heat Stress

Heat stress is the illness that occurs when your body is subjected to more heat than it can cope with. Heat stress is not caused by exposure to pesticides but may affect pesticide handlers who are working in hot conditions. Personal protective equipment worn during pesticide handling activities can increase the risk of heat stress by limiting your body's ability to cool down. If you are under a physician's care, you should consult your physician before working in hot conditions.

### Signs and Symptoms of Heat Stress

Mild forms of heat stress will make you feel ill and impair your ability to do a good job. You may get tired sooner, feel weak, be less alert, and be less able to use good judgment. Severe heat stress is a serious illness. Unless victims are cooled down quickly, they can die. Severe heat stress is fatal to more than 10 percent of its victims, even young, healthy adults. Many who survive suffer permanent damage. Sometimes the victims remain highly sensitive to heat for months and are unable to return to the same work.

Learn the signs and symptoms of heat stress and take immediate action to cool down if you suspect you may



Heat Stress

---

## Protecting Your

---

### Body and the

---

### Environment

---

be suffering from even mild heat stress. Signs and symptoms may include:

- fatigue (exhaustion, muscle weakness),
- headache, nausea, and chills,
- dizziness and fainting,
- severe thirst and dry mouth,
- clammy skin or hot, dry skin,
- heavy sweating or complete lack of sweating,
- altered behavior (confusion, slurred speech, quarrelsome or irrational attitude).

#### First Aid for Heat Stress

It is not always easy to tell the difference between heat stress illness and pesticide poisoning. The signs and symptoms are similar. Don't waste time trying to decide what is causing the illness. Get medical help.

First aid measures for heat stress victims are similar to those for persons who are overexposed to pesticides:

- Get the victim into a shaded or cool area.
- Cool victim as rapidly as possible by sponging or splashing skin, especially face, neck, hands, and forearms, with cool water or, when possible, immersing in cool water.
- Carefully remove all personal protective equipment and any other clothing that may be making the victim too warm,
- Have the victim, if conscious, drink as much cool water as possible.
- Keep the victim quiet until help arrives.

Severe heat stress or heat stroke is a medical emergency! Brain damage and death may result if treatment is delayed.

#### Heat Cramps

Heat cramps can be quite painful. These muscle spasms in the legs, arms, or stomach are caused by loss of body salt through heavy sweating. To relieve cramps, have the victim drink lightly salted water or "sports drinks." Stretching or kneading the

muscles may temporarily relieve the cramps. However, if you suspect that stomach cramps are being caused by pesticides rather than heavy sweating, get medical help right away.

## Cleanup of Pesticide Spills

### Minor Spills

*Keep people away from spilled chemicals.* Rope off the area and flag it to warn people. Do not leave unless someone is there to confine the spill and warn of the danger. If the pesticide was spilled on anyone, wash it off immediately.

*Confine the spill.* If it starts to spread, dike it up with sand or soil. Use absorbent material such as soil, sawdust, or an absorbent clay to soak up the spill. Shovel all contaminated material into a leak-proof container for disposal. Dispose of it as you would a pesticide waste. Do not hose down the area, because this spreads the chemical. Always work carefully and do not hurry.

*Do not let anyone except properly trained persons enter the area until the spill is completely cleaned up.*

### Major Spills

The cleanup of a major spill may be too difficult for you to handle, or you may not be sure of what to do. In either case, keep people away, give first aid if needed, and confine the spill. Then call CHEMTREC, the local fire department, and state pesticide authorities for help.

CHEMTREC stands for Chemical Transportation Emergency Center, a public service of the Manufacturing Chemicals Association. Its offices are located in Washington, D.C. CHEMTREC provides immediate advice for those at the scene of emergencies.

CHEMTREC operates 24 hours a day, seven days a week, to receive calls for emergency assistance. For help in chemical emergencies involving spills, leaks, fire, or explosions, call toll-free 800-424-9300 day or night. This number is for emergencies only.

---

## Protecting Your Body and the Environment

---

---

If a major pesticide spill occurs on a highway, have someone call the highway patrol or the sheriff for help. (Carry these phone numbers with you.) Do not leave until responsible help arrives.

### Cleanup Notification of Pesticide Spills

#### Minor Spills

Generally speaking, a minor spill is one involving one quart or approximately two pounds or less of pesticide concentrate. However, common sense must be used in determining how much action you as an individual take regarding pesticide spills. For example, one quart of a highly toxic insecticide requires more expertise and precautions in handling cleanup and disposal than does one quart of low toxicity herbicide.

Keeping the product toxicity in mind, a general procedure for cleaning up a minor spill should be to use an absorbent such as pet litter, cover with bleach, and scrub the area with detergent. Then follow label statements for disposal or telephone the State Department of Health and Environment (785-296-1600) or the State Department of Agriculture (785-296-3786) for further instructions on disposal.

#### Major Spills

Pesticide spills caused by commercial spray rigs, aerial spray planes, and large pesticide containers may be too big to be handled by one person. There are certain procedures one should follow to notify the proper authorities.

All spills should be reported by telephone to the Kansas Division of Emergency Management 785-296-3176. If contact cannot be made, you should notify the local authorities such as the police department, fire department or civil defense office.

If individuals have been exposed to the spilled pesticide, the local poison control center should be notified.

Every effort should be taken to keep other people from being exposed to the spill until local authorities can assume responsibility at the site.

For all problems, accidents, or incidents that occur, you should have a list of the phone numbers of these authorities available and accessible.

#### Pesticide Regulatory Agencies

Department of Emergency  
Management..... 785-296-3176  
or 1-800-905-7521  
Department of Health and  
Environment ..... 785-296-1600  
Kansas Department  
of Agriculture ..... 785-296-3786

#### Pesticide Emergency Phone Numbers

1. Local Poison Control Center: .....
2. County Extension Agent: .....
3. Local Police Department:  
City .....
- County .....
- State .....
4. Local Fire Department: .....
5. Civil Defense: .....
6. Department of Emergency  
Management: ..... 785-296-3176  
or 1-800-905-7521
7. Department of Health and  
Environment: ..... 785-296-1600
8. Kansas Department  
of Agriculture: ..... 785-296-3786
9. U.S. Environmental  
Protection Agency  
Region VII Office...1- 800-223-0425
10. Mid-America  
Poison Center ..... 1-800-222-1222

Before authorities arrive, get a copy of the pesticide label and if possible determine the toxicity of the pesticide involved. Information from the label can be very helpful to the doctor.

#### Protecting Animals

Pesticides can protect animals from pests, but they may be toxic to the animals being treated as well as to the pests. Apply them correctly to prevent adverse effects. Animals may be sensitive to certain pesticides. Poisoning signs usually include excessive



Pesticide Emergency Line



---

## Protecting Your

---

## Body and the

---

## Environment

---

salivation, eye watering, defecation, urination, and muscle twitching.

**DO NOT** treat animals which are under stress or which will be put under stress. Be careful not to overdose young or smaller animals. When planning a pesticide application, choose the pesticide which has the least risk of adverse effects and will give good control.

### Protecting the Environment

The “environment” is our surroundings and its many forms of life. Every plant or animal is affected by other plants or animals in the environment. Factors like rain, temperature, and wind are part of the environment. We cannot do much about them, but we can control some other things, including the use of pesticides.

Many people consider pesticides a tool for preserving or improving the environment. Others feel that they cause pollution. Correct use prevents pollution by pesticides.

Using pesticides in a way other than as directed on the label can injure plants and animals, leave illegal residues, and damage the environment in many other ways.

Any pesticide can cause harm if not chosen and used with care. Here are some ways damage can occur.

#### Potential Hazards

When pesticides are used in a way other than as directed on the label, they can:

- injure nontarget plants and animals,
- leave harmful residues,
- move from the application site into the surrounding environment, and
- move into the groundwater and surface waters.

#### Direct Kill of Non-target Plants and Animals

Pesticides which are improperly applied can kill non-target organisms. Drift from the target area may injure fish, birds, other wildlife, and sensi-

tive plants. Humans may also be exposed to pesticides because of drift. Drift of herbicides can damage nearby crops, forests, or landscape plantings. Poorly timed applications can kill bees and other pollinators which are working in the area, or kill beneficial parasites and predators that help control pests.

Runoff from treated areas can kill fish and other aquatic animals and plants in nearby ponds, streams, and lakes. Aquatic life also can be killed by careless tank filling or draining and by rinsing or discarding used containers along or in waterways.

Pesticides can harm other wildlife, too. Even tiny amounts of pesticide may kill them or destroy their source of food.

Ask for help in choosing the safest pesticide for the job. Injury or death to non-target plants and animals can lead to lawsuits, fines, and loss of your applicator certification, and/or criminal charges.

#### Persistence and Accumulation

Pesticides can be harmful in the environment even if they do not cause direct kills of non-target plants and animals. Some pesticides can build up in the bodies of animals (including humans). These are called *accumulative* pesticides. The chemicals may be stored in an animal’s body until they are harmful to it or to the meat-eater which feeds on it. Long-term effects include eggs that will not hatch and young that will not develop normally. The behavior of an animal may be altered so that predators can more easily catch and kill it. Many accumulative pesticides are in the chlorinated hydrocarbon family (eg. dieldrin, endrin, heptachlor, and aldrin) and have limited uses in the United States.

Some pesticides stay in the environment without change for long periods of time. These are *persistent* pesticides. Persistent pesticides which are not stored by animal tissues are often harmless to the environment. They may stay on or in the soil and give long-term pest control without



repeated applications. Sometimes these pesticides injure sensitive plants in the treated soil.

Pesticides which break down quickly in the environment to form harmless materials are called *nonpersistent*. These pesticides are often broken down easily by microorganisms or sunlight or are highly soluble in water. Most organophosphate and carbamate insecticides are nonpersistent.

### **Pesticide Movement**

Pesticides which move away from the target area are problems in the environment. Highly volatile pesticides such as 2,4-D esters can move great distances as invisible vapor in the air and injure non-target plants. Dusts, aerosols, and fogs can easily drift away from the target area with air currents. Any application that produces fine dust or spray particles may result in drift.

Pesticides move off target in other ways also. They may be carried off target by rain and runoff water. They may leach through the soil to areas nearby or to groundwater below.

Whenever you are applying a pesticide, select the pesticide, the formulation, and the application equipment which will most likely result in an application which stays on target.

### **Contamination of Soils**

Pesticides which move off target onto soil or which persist in soil may limit the use of that soil. Agricultural, ornamental, turf, and forestry crops may be killed or contaminated if planted on the site. Residential, grazing, and recreational uses of the soil may be impossible if the soil contains pesticide residues. The pesticide label will list crop rotation limits and other growing restrictions.

### **Contamination of Air**

The movement of pesticides in the air cannot be controlled. The polluted air creates a hazard for people, animals, or plants that come into contact

with it. Pesticides in the air may settle onto water, crops, livestock, trees, parks, or houses. Provide adequate spacing or a buffer zone when applying pesticides near sensitive areas. Keep in mind that the wind can carry pesticide particles or droplets many miles off target.

### **Contamination of Surface Water**

Water is necessary for all life. Humans and animals need clean water for drinking and bathing. Most fish and other aquatic animals and plants can survive only slight contamination of their water environment.

Farmers, ranchers, horticulturists, foresters, and turf growers need uncontaminated water for their livestock and for irrigation. Polluted water can injure the plants or animals directly or cause illegal residues in the food, feed, poultry, or livestock products.

Pesticides get into water in many ways. Sometimes they are applied directly to the water to control aquatic pests. Pesticide contamination of water occurs most often when pesticides reach the water through carelessness or misuse of pesticides, such as atrazine.

### **Contamination of Groundwater**

Groundwater is by far the largest water resource in Kansas. Pumped from thousands of wells, it is used by virtually every person in Kansas every day. A few of the uses of groundwater include drinking, cooking, irrigating, municipal, industrial, and recreational (such as swimming pools).

In general, the sources of groundwater include water from rain (and other precipitation), lakes, streams, ponds, etc., which slowly leaches through the surface soil and accumulates in the underlying sand and gravel layers. Such layers may be only a few feet from the soil surface and others are several hundred feet below. These groundwater collection layers are called *aquifers* and can be thought of as underground lakes.

# Groundwater and Land Use in the Water Cycle

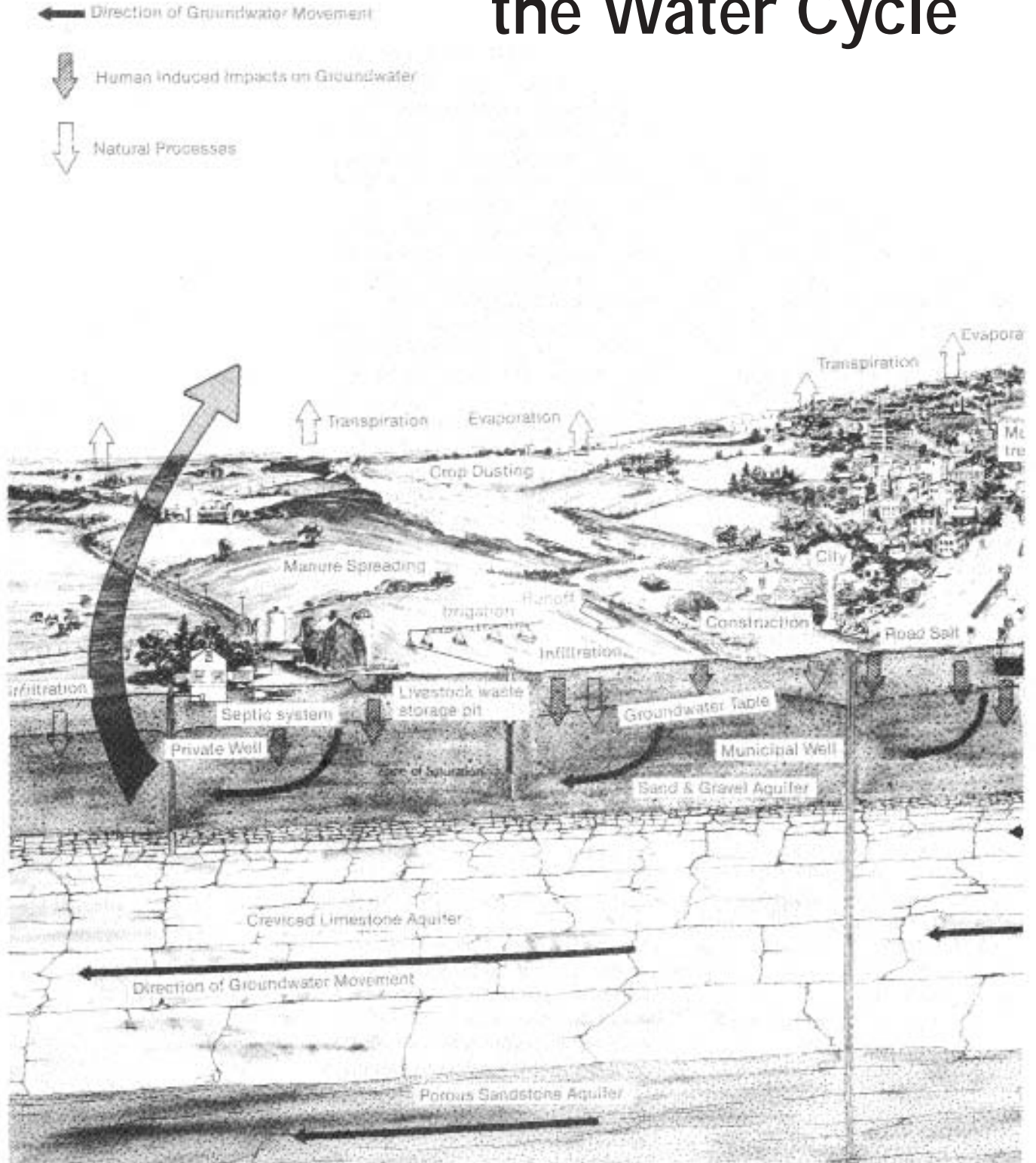

---

# Protecting Your Body and the Environment

---

---

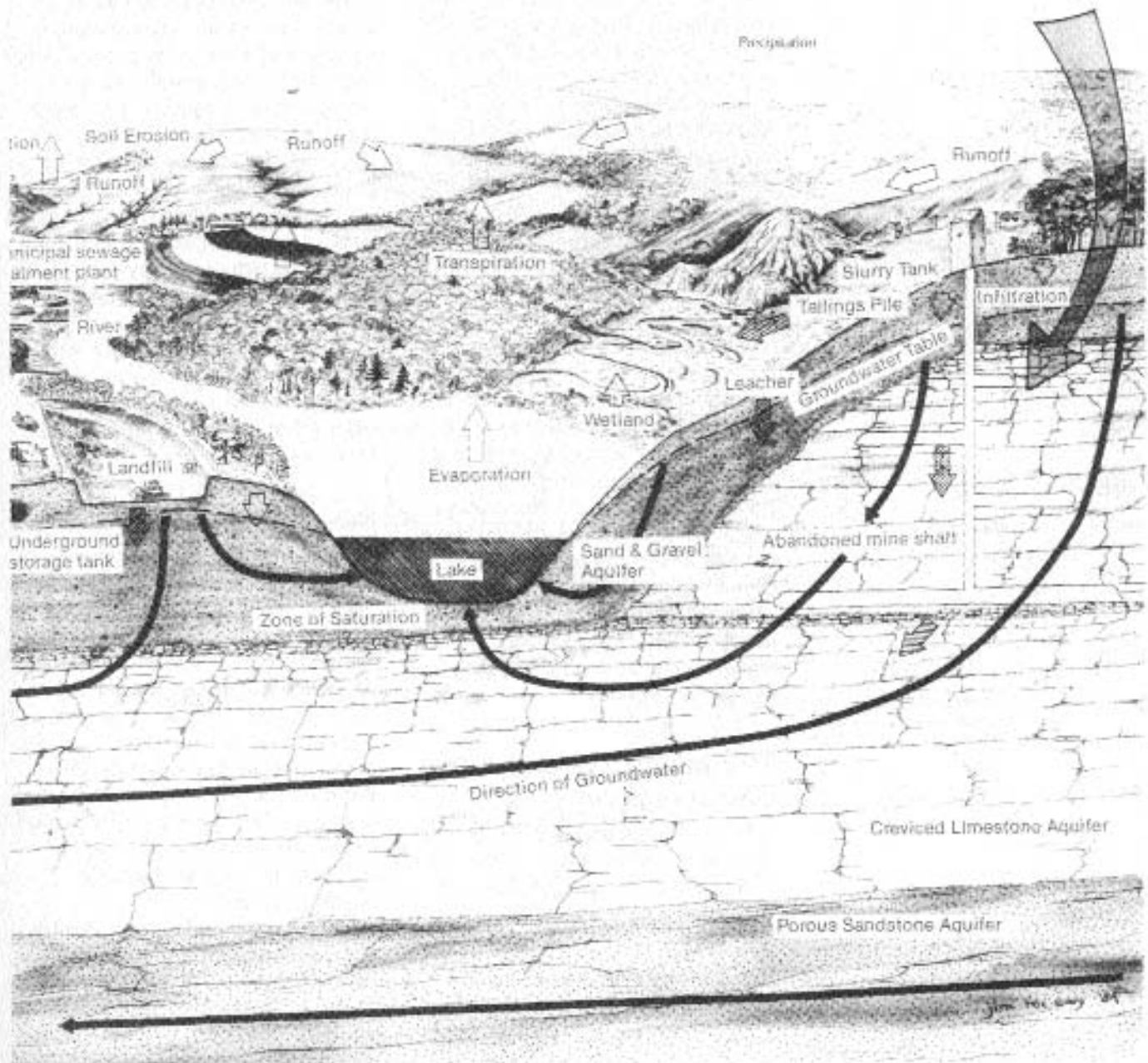



---

## Protecting Your

---

## Body and the

---

## Environment

---

There are many potential sources of groundwater contamination. Some of these include industrial and municipal wastes, livestock and human waste septic systems, pesticide use, and various microbes. Fortunately, as the water slowly leaches through the soil, most (if not all) of these contaminants are removed through chemical and microbiological actions in the soil. However, aquifers which are only a few feet below the soil surface are being found contaminated with a variety of chemicals—including pesticides. Abandoned, unplugged farmstead, irrigation, stock water, etc. wells serve as direct conduits to the groundwater. Studies are presently intensifying to determine the extent of groundwater contamination.

When filling a sprayer tank, **ALWAYS** be absolutely sure that the hose-end is in such a position that it can **NOT** become submerged as the tank fills. Never leave to do other things when the tank is being filled. By following these two procedures, a pump power failure will not result in a back-siphon that could result in the water source becoming contaminated.

Pesticides are essential chemical tools used in the production, transportation, and storage of food, feed, and fiber. They are also vital in pest control related to food preparation and serving, and in health and recreation related situations. It is extremely important that pesticide users recognize the importance of properly handling pesticides to avoid surface water and soil contamination with these chemicals.

### Minimizing Groundwater Contamination

Pesticide contamination of groundwater is a public concern. Contamination results from two types of sources—point and non-point.

#### Point Source Contamination

Point source contamination results from localized spills or accidents, which is to say, the contamination

can be traced back to an identifiable area. Point source contamination accounts for large doses being introduced into groundwater and as a result poses the greatest risk of rendering the water unfit for drinking.

Spills and other mishaps which occur during the handling and mixing of pesticides are a major contributing factor. There are several steps we can take to minimize contamination.

Wells are a direct conduit to the groundwater and extra care should be taken at these sites when handling pesticides. In addition, many wells are not adequately sealed which increases the risk of contamination in the event of a spill. Mix pesticides at least 200 ft. from a well. Using a nurse-tank as a water source helps avoid these problems. Prevent back-siphoning into the well. Keep the end of the filler hose above the water level of the tank at all times. Anti-backflow devices for hoses can be purchased from irrigation and spray equipment suppliers. Clean up spills, especially near wells and other water supplies.

Additional practices which help prevent point source contamination include triple-rinsing and the proper disposal of pesticide containers and excess pesticides.

#### Non-point Source Contamination

Contamination which occurs from non-point sources cannot be traced back to a specific location or event. Examples of non-point source contamination would include the leaching of pesticides through the normal course of pesticide use, or pesticides carried in surface run-off as a result of soil erosion. The extent of non-point source contamination is dependent upon pesticide (herbicide, insecticide, fungicide), soil, geological, production management, and weather factors.

There are several practices which minimize non-point source contamination. Apply the proper amount of pesticide for the crop, pest and site. Read the label to determine what the minimum use rate is. Proper sprayer

calibration assures application uniformity and more effective control. The amount of product can also be reduced by using band applications instead of broadcast treatments. These practices not only reduce the potential for groundwater contamination but also decrease the chance of crop injury, residual problems and make control more economical.

In choosing a herbicide, less mobile, short residual products are less likely to leach to the water table. Crop and herbicide rotation also reduces risk as a result of using different herbicides each year.

It is also helpful to identify high risk areas. The greatest risk for contamination exists where the groundwater table is close to the soil surface. In addition, herbicides are more likely to contaminate groundwater when applications are made to coarse textured soils low in organic matter. High pH soils also present concerns because some herbicides leach more readily under these conditions. Extra care should be taken when any of these situations exist.

## Chemigation

In Kansas, chemigation is regulated by the "Kansas Chemigation Law." The basic intent of this law is to protect surface and groundwater from contamination by fertilizers and pesticides. There are specific requirements, such as paying a fee, passing an examination, completing the registration forms, etc., which must be met in order to chemigate. Several important terms in relation to chemigation are defined below.

"Chemigation" is any process whereby pesticides, fertilizers or other chemicals or animal wastes are added to irrigation water applied to land or crops, or both, through an irrigation distribution system.

"Irrigation distribution system" is any device or combination of devices having a hose, pipe or other conduit which connects directly to any source of surface or groundwater, through which water or a mixture of water and chemicals is drawn and applied to land. The term does not include any handheld hose sprayer or other

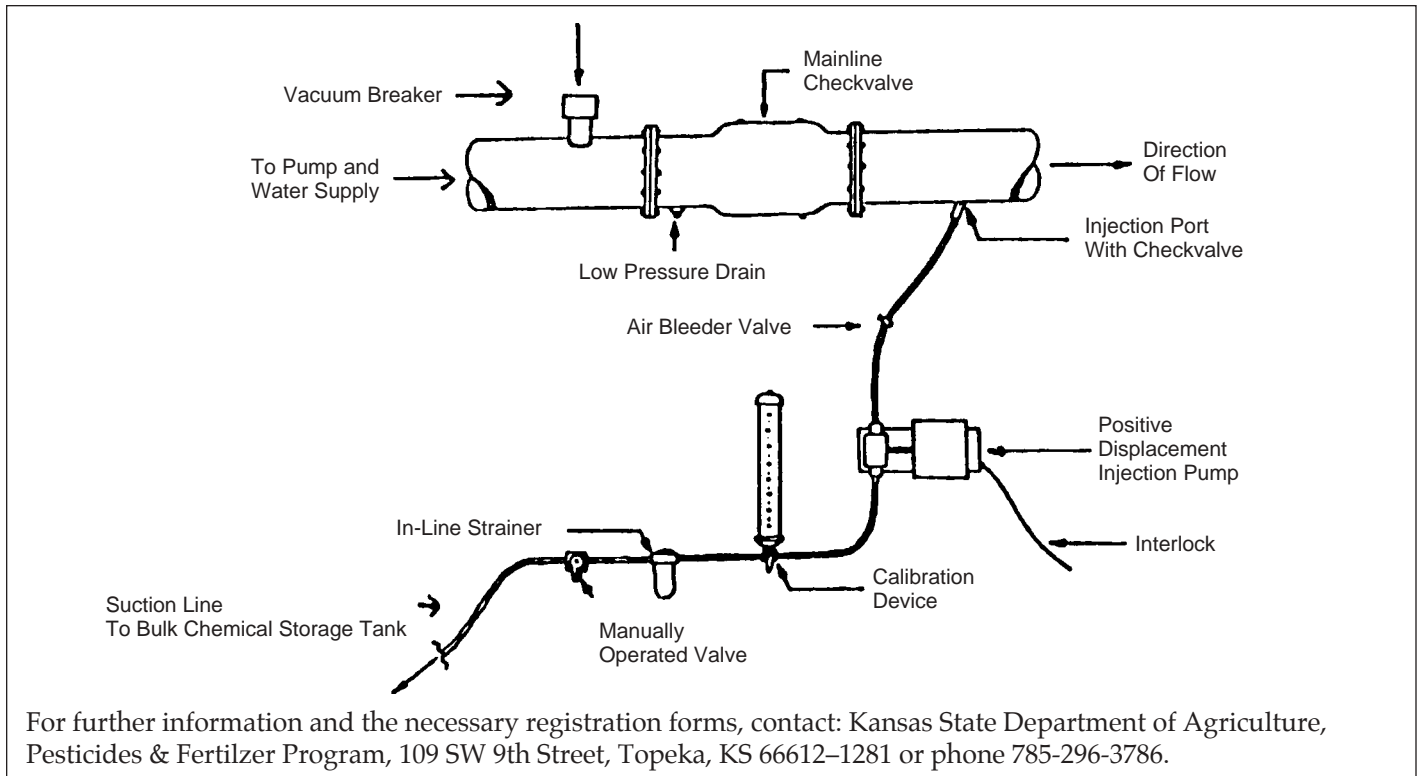

For further information and the necessary registration forms, contact: Kansas State Department of Agriculture, Pesticides & Fertilizer Program, 109 SW 9th Street, Topeka, KS 66612-1281 or phone 785-296-3786.



---

## Protecting Your

---

## Body and the

---

## Environment

---

similar device which is constructed so that an interruption in water flow automatically prevents any backflow to the water source. Nor does it include greenhouse irrigation or residence yards.

“Operating chemigation equipment” includes:

- preparation of the solution and filling the chemical supply container,
- calibration of injection equipment,
- starting and stopping the equipment when injection of chemicals is involved, and
- supervision of the chemigation equipment to assure its safe operation.

“*Supervision*” means the attention given to the chemigating system during its operation when chemicals are being applied. “*Direct supervision*” means supervision with ability to change the procedures.

“*Anti-pollution devices*” means the mechanical equipment used to reduce hazard to the environment in cases of malfunction of the equipment during chemigation and includes (but is not limited to): interlock, waterline check valve, chemical line closure device, vacuum relief device and automatic low pressure drain.

### Pesticides and Bees

While there are other species of bees, the honeybee is the only one that produces surplus honey and wax, pollinates important agricultural crops, contributes to natural food chains by pollinating wildlife food plants, and provides important sources of income and recreation. Chemical pesticide destruction of these bees would significantly affect millions of dollars worth of honey, wax, and bee-pollinated agricultural crops. While colony losses are not as extensive or severe as in other areas in the country, serious losses routinely occur each year.

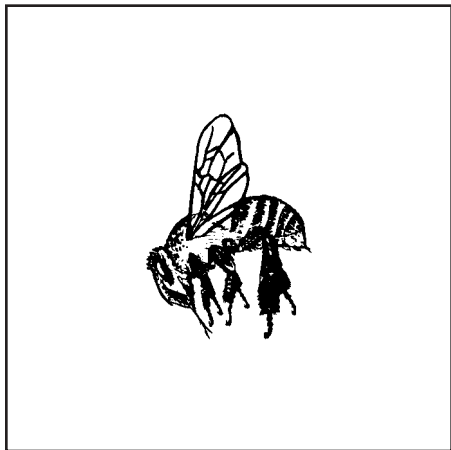

Honeybee

### Usefulness of Honeybees

By visiting flowers, bees follow a pattern set by their behavior and biology. Colony numbers vary according to the time of the year, but the colony is always social. Boxes, called hive bodies, contain 8 to 10 movable frames in which the honeycomb is built and where bees raise the young and store honey. Each colony may require one or more hive bodies, and contain from 10,000 to 60,000 or more bees.

### Protecting Bees from Pesticides

*Do not spray while crops are in bloom:* Apply insecticides to target plants or weeds when still in the bud stage, or just after flowering.

*Spray when bees are not flying:* Bees fly on sunny days when the air temperature is above 55–60°F. Bees are most active from 8 a.m. to 5 p.m., but applicators should always check a field for bee activity immediately before spraying. Pesticides hazardous to honeybees must be applied to blooming plants when bees are not working and preferably in the early evening. Evening applications allow decomposition time for many chemicals and new, unsprayed flowers to open overnight.

*Do not contaminate water.* Bees require water to cool the hive and feed young bees. They will be killed if the water is contaminated. Never spray standing water or drain spray tank contents onto the ground to create puddles.

*Use less toxic compound:* Many pest control situations give the grower-applicator some choice in the compound to use. Those hazardous to honeybees must state such on the label, in which case another may be selected. Generally, botanical materials, specific miticides, dinitro compounds, fungicides and herbicides are relatively non-toxic to honeybees. However, there is new research evidence that some herbicides and fungicides might be affecting bee develop-

ment, so it is wise for the grower to use caution with all pesticides when bees are involved.

Consult your county Agricultural Extension Agent for details, recommendations, and further information about bee toxicity to specific compounds.

**Use less toxic formulations:** Not all compounds are the same when made into different formulations. Research and experience indicate that:

- Dusts are more hazardous to bees than liquid formulations.
- Encapsulated formulations are especially hazardous.
- Emulsifiable concentrates have shorter killing power than wettable powders.
- Ultra-low-volume (ULV) formulations often are much more hazardous to bees than other liquid formulations.

**Eliminate attractive weeds:** Prior to insecticide treatment, mow, beat, or otherwise control flowering weeds in orchards, nurseries, or other situa-

tions where insecticides are to be applied to non-flowering plants.

**Choose application technique wisely:** Use the application technique that is most precise to avoid contamination of non-target crops. Drift by moving air currents and wind adds to the contamination problem.

**Notify beekeepers:** Some beekeepers will move bees from a spray area, but they need at least 48 hours notice. Others may wish to cover colonies.

**Protect colonies in the area:** Work with beekeepers so they will locate their apiaries where they will not be directly sprayed with any type of pesticide. Beekeepers may wish to loosely cover hives with burlap or coarse cloth to confine bees so they cannot fly, yet allowing them to cluster outside the hive, under the cloth. Repeated sprinkling with water will prevent bees from overheating. Communications among growers, applicators, and beekeepers are essential to prevent bee losses.

---

## Protecting Your

---

## Body and the

---

## Environment

---

# Application Equipment

The pesticide application equipment you use is important to the success of your pest control job. You must first select the right kind of application equipment. Then you must use it correctly to suit your needs and take good care of it. These things are true whether you use hand-carried, tractor-drawn, self-propelled or aircraft-mounted equipment. Here are some things you should know about choosing, using, and caring for equipment.

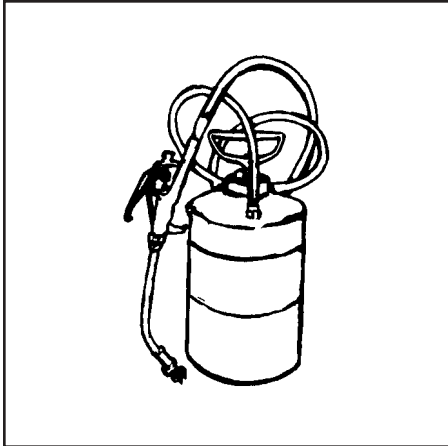

Portable Sprayer

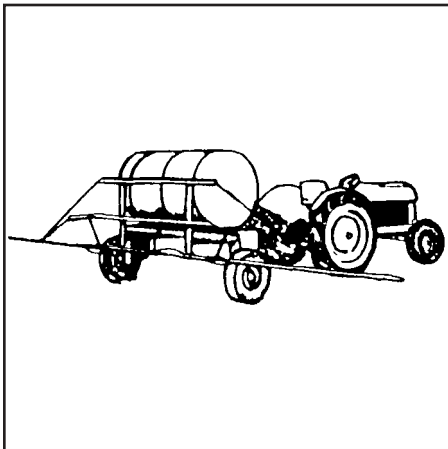

Low Pressure Sprayer

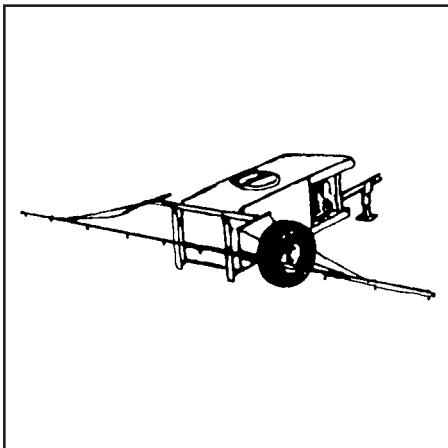

High Pressure Sprayer

## Sprayers

Your sprayer should be designed to do the job you want to do. It should be durable and convenient to fill, operate, and clean.

### Hand Sprayers

Hand sprayers are used for small jobs. You can use them in restricted areas where a power unit would not work.

#### Advantages :

- economical,
- simple, and
- easy to use, clean, and store.

#### Limitation :

- frequent lack of good agitation and screening for wetttable powders. Keep WP's in suspension by shaking the sprayer.

### Low Pressure Hydraulic Sprayers

These sprayers deliver low to moderate volume at 15 to 50 psi. Most of these are used for treating field and forage crops, pastures, fencer rows, and structures. They also may apply fertilizer-pesticide mixtures.

#### Advantages :

- medium to large tanks,
- low cost, and
- light weight.

#### Limitations:

- low-gallonage output may limit their use when high volume is required, for example, liquid fertilizer applications,

- low pressure limits versatility, and
- agitation system may be of limited capacity.

### High Pressure Sprayers

These are designed to deliver medium volumes at high pressure. They are used to spray fruits, vegetables, trees, landscape plants, and livestock. When fitted with the correct pressure regulators, they can also be used at low pressures. Applications usually are made at high gallonages (100 gallons or more per acre above 100 psi). Even though very large tanks are used, they may need to be filled often.

#### Advantages:

- well built,
- usually have mechanical agitation, and
- last a long time even when using abrasive solutions.

#### Limitations:

- high cost,
- large amounts of water, power, and fuel needed,
- high tire loads, and
- high pressure capability which makes a spray that drifts easily.

### Air Blast Sprayers

These units use a high speed, fan-driven air stream to break the nozzle output into fine drops which move with the air stream to the target. The air is directed to either one or both sides as the sprayer moves forward. These sprayers are used in applying pesticides to landscape plants, fruits, and vegetables, and for biting fly control. Most air blast sprayers can be adapted to apply either high or low volumes of spray. **These sprayers should not normally be used to apply herbicides or for field broadcast applications.**

#### Advantages:

- good coverage and penetration,
- low pump pressures, and
- mechanical agitation.

#### Limitations:

- drift hazards,
- chance of overdosages,

- difficult to use in small areas, and
- hard to confine discharge to limited target areas.

### Ultra-Low-Volume (ULV) Sprayers

ULV's deliver undiluted pesticides from the air, on the ground, or in buildings.

#### Advantages:

- no water is normally needed, and
- equal control with less gallonage.

#### Limitations:

- does not provide for thorough wetting,
- hazards of using high concentrates,
- chance of overdosage, and
- small number of pesticides labeled for use in this manner.

### Nozzles

Agricultural chemical spraying is becoming increasingly sophisticated and precise. Chemicals used by farmers today are designed for specific needs and require different nozzles to be applied properly.

The difference in nozzle styles is important because it is the nozzle that actually dispenses thousands of chemical and fertilizer dollars. Yet, labels on these products often contain little information about the kind of spray nozzle that should be used.

Kansas farmers use five basic kinds of spray nozzles: the flat fan, even flat fan, hollow cone, solid cone, and flooding spray.

Each has a specific use, distinctive spray distribution, and operating requirements. These nozzle styles, along with the Raindrop (Delevan) and Whirl Jets (Spraying Systems), are summarized according to recommended uses, distinctive spray distributions, and operating requirements in Table 1, "Nozzle Styles," and in Table 2, "Nozzle Operations."

### Questions to Consider

It is not easy to make specific nozzle recommendations because many questions must be considered.

- What kind of chemical will be sprayed: herbicide, insecticide, fungicide?
- What is the chemical's formulation: wettable powder, flowable, emulsifiable concentrate?
- When is the chemical used: pre-plant incorporated, preemerge, postemerge?
- Is spray drift a problem?
- What will carry the chemical: water, liquid fertilizer?
- Will two or more chemicals be used in combination?
- What kind of sprayer will be used in the application: airplane, ground sprayer, floater, kit attached to some other farm implement?
- What pressure range is desired?
- What speed will sprayer operate?
- What is nozzle spacing on boom?

### Nozzle Selection Procedure

Refer to Table 1, Nozzle Styles, to determine the proper nozzle pattern for the intended use and particular sprayer. Then you can select the correct size of nozzle to insure proper chemical distribution.

- Step 1. Determine the sprayer application volume in gallons per acre (gpa) from the pesticide label or printed recommendations. The application volume is the gallons of carrier (water, fertilizer) plus the amount of chemical formulation applied per treated acre.
- Step 2. Select an appropriate ground speed in miles per hour (mph) according to existing field conditions. The actual speed should be measured as part of the calibration procedure.
- Step 3. Determine the spray width per nozzle ( $w$ ) in inches. For boom spraying,  $w$  = the nozzle spacing. For band spraying,  $w$  = band width. For foliar applications, such as row-crop spraying from drop pipes or direct spraying.

## Application

## Equipment

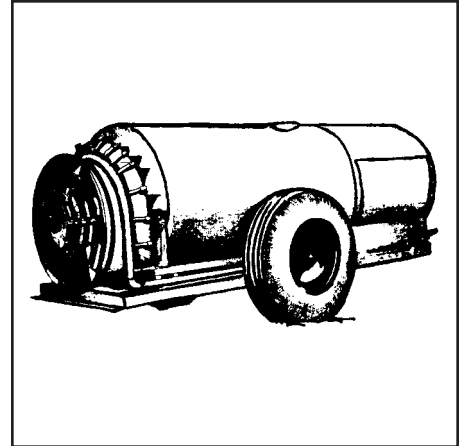

Air Blast Sprayer

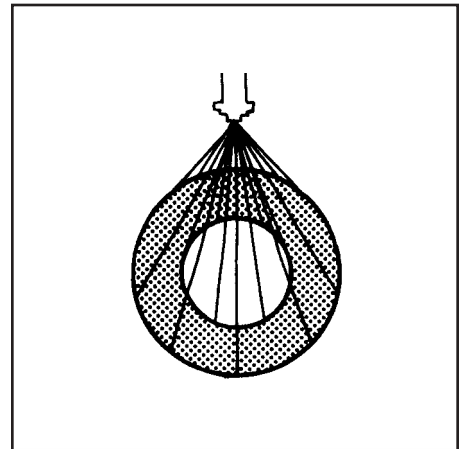

Hollow Cone Spray

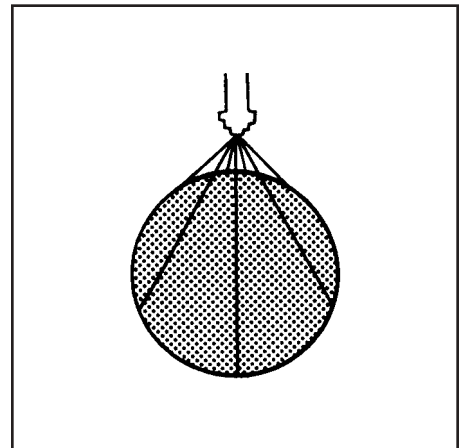

Solid Cone Spray

# Application

## Equipment

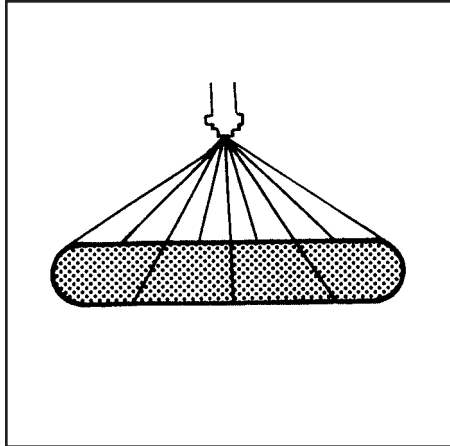

Even Spray

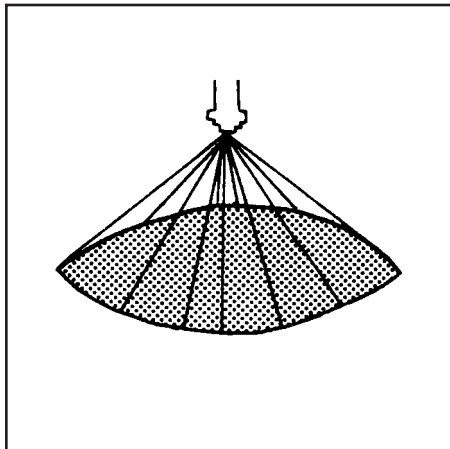

Flat Spray

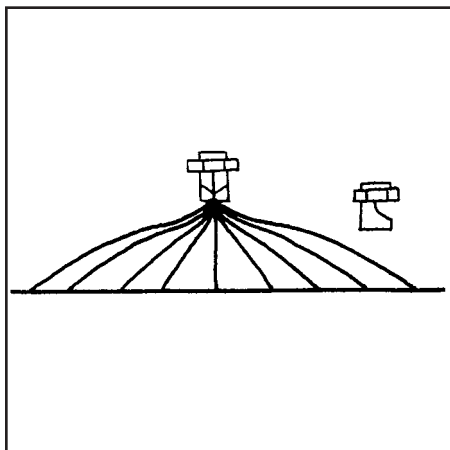

Flooding Spray

$$w = \frac{\text{row spacing}}{\text{number of nozzles per row}}$$

Step 4. Determine the output required for each nozzle by using a manufacturer's catalog or this equation:

$$\text{gpm} = \frac{\text{gpa} \times \text{mph} \times w}{5940^*}$$

gpm = individual nozzle output in gallons per minute

gpa = label requirements in gallons per acre

mph = speed of applicator in miles per hour

w = width in inches sprayed per nozzle as determined in step 3

\*Using 6,000 instead of 5,940 makes the calculation easier and results in an error of only one percent.

Step 5. Select a nozzle size from the manufacturer's catalog that will give the gpm output when operating at the desired pressure.

You can purchase nozzles in many materials. Here are the main features of each kind.

**Brass:**

- inexpensive,
- wears quickly from abrasion,
- probably the best material for **limited** use.

**Stainless steel:**

- will not corrode, and
- resists abrasion, especially if it is hardened.

**Nylon :**

- resists corrosion and abrasion
- some solvents may cause swelling of older nylon compounds.

- available in color coding for easy identification

New combination nozzles featuring stainless steel orifice inserts in injection molded nylon bodies offer the advantages of both stainless steel and nylon at a reasonable price.

The formulation of the pesticide being sprayed determines the material of which the nozzle can be made. Brass nozzle tips should not be used with wettable powder or other abrasive formulations. The relative costs of materials are summarized in figure below: Nozzle Material.

For most Kansas farm sprayers involved in a yearly spraying program, the stainless steel/nylon combination nozzles will be the cheapest over the life of the sprayer.

### Check Nozzles Often

Keep nozzles in good working condition. For most boom applications, select nozzles of uniform type and size.

Nozzle caps should not be overtightened. Adjust nozzle height and spacing to suit the target. Follow the nozzle manufacturer's instructions and the pesticide label. Allow for crop or weed height if necessary. Check each nozzle for uniform flow using water and a jar marked in ounces.

With the sprayer running, hold a jar under each nozzle and time how long it takes to fill the jar. There should be no more than 10 percent difference among all the nozzles. Replace any nozzle tips that discharge  $\pm 5$  percent more than specified by the nozzle manufacturer when new.

**Nozzle Material  
(Delavan LF-3-80° with Wettable Powder)**

Material	Life (Hrs.)	Initial Cost Factor	Actual Cost/Hr. Factor
Brass	100	1.0	1.0
Nylon	300	1.9	0.64
Stainless Steel	500	2.9	0.57



---

## Application

---

## Equipment

---

---

---

Replace any nozzles having faulty spray patterns. A good check is to spray on asphalt pavement moving slow enough to get the area thoroughly wet. Watch for streaks as you increase speed or as spray dries.

Clean nozzles only with a toothbrush or wooden toothpick. A nail or pocket knife can damage the nozzle tip and ruin the spray pattern.

### Operation and Maintenance

Always read and follow the operator's manuals for all your spray equipment. They will tell you exactly how to use and care for it. After each use, rinse out the entire system. Remove and clean nozzles, nozzle screens, and strainers, and complete any maintenance required. Check for leaks in lines, valves, seals, and tank both after filling with water and during running.

Be alert for nozzle clogging and changes in nozzle patterns. If nozzles clog or other trouble occurs in the field, be careful not to contaminate yourself while correcting the problem. Shut off the sprayer and move it to the edge of the field before dismounting. Wear protective clothing while making repairs.

*Clean the sprayer thoroughly when changing chemicals or before storing. Contamination from the previous chemical can injure your crop or react with the new chemical to decrease its effectiveness.* The following steps are suggested for a thorough cleaning. Spray and mix/load equipment should have been thoroughly rinsed with clean water and the rinsate applied to a field area prior to the cleaning process. Additional precautions may be necessary for certain chemicals.

1. Choose a cleaning area so that the discharge will not contaminate streams or water supplies. Keep children, pets, and livestock away from puddles.



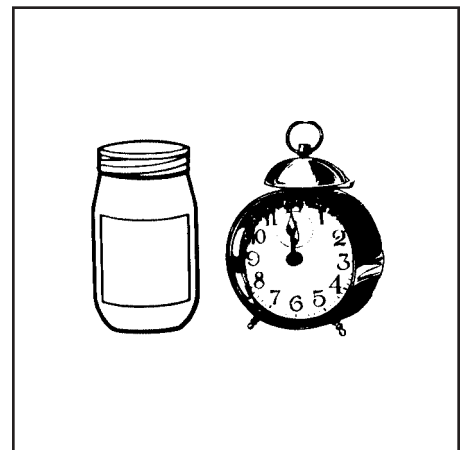







2. Hose down the inside of the tank and fill it about half full. Then flush the cleaning water out through the nozzles by operating the sprayer.
3. Repeat step 2.
4. Fill the tank about half full of water and add about one pound of detergent per 50 gallons of water. Circulate the detergent through the sprayer for about  $\frac{1}{2}$  hour, then spray it out.
5. If you have last used 2,4-D or an organophosphate chemical, continue the cleaning process by replacing the screens and nozzle tips. Then fill the sprayer half full of water and add one pint of ammonia for each 25 gallons of water. Circulate this solution through the sprayer for a short while, then discharge a small amount through the nozzles. Let the remaining solution stand in the sprayer overnight, and discharge it in the morning.
6. Flush the sprayer one final time with clean water.
7. Remove the nozzle tips and screens and clean them with kerosene or a detergent solution. Nozzle tips should be dried and stored in a dry place or may be stored in light oil or diesel fuel.
8. If the sprayer is to be stored, fill tank almost full with clean water. Add a small amount of new light oil to the tank. Coat the system by pumping tank contents out through nozzles or handgun. Drain the pump and plug its openings or fill the pump with light oil or antifreeze. Remove nozzles and nozzle screens and store in light oil or diesel fuel.



Check Fill-time

# Application

# Equipment

<b>Table 1. Nozzle Styles</b>				
Style	Suggested Use	Recommended Pressure (psi)	Comments	Single Nozzle Distribution Pattern
Flat Spray	Weed and brush control.	10–30; never exceed 40	Reasonably coarse spray in a fan-type pattern that will overlap along a spray boom. Wider operating pressure ranges may be used with certain “wide range” flat fan nozzle tips.	Bell Shaped 
Even Spray	Band application of preemergence and postemergence herbicides	15–30; never exceed 40	Fan-type pattern that gives a uniform volume of spray across entire fan width.	Rectangular Shaped 
Cone	Insecticides and fungicides (foliar applications).	60 and above	Circular fan-type pattern giving good penetration of sprayed surfaces.	Hollow Cone  Solid Cone 
Flooding Spray	Preemergence and postemergence herbicides where drift is hazardous	8–20 for maximum drift control; never exceed 40	Coarse fan-type pattern. Sprays wide surface yet can be sprayed close to surface. Nozzle spacing should be 60 “ or less for herbicide applications.	Flooding Spray 
Raindrop®	Preemergence and postemergence herbicides where drift control is needed. (Aerial and ground applications.)	20–60 psi	Produces very large drops in a hollow cone pattern	Raindrop 
Whirl Jet®	Herbicide incorporation kits.	5–20 psi	Produces medium size drops in a hollow cone pattern with typical fan angles up to 140°.	Whirl Jet 
Raindrop Flat Fan	Weed and brush control.	10–40 psi	Special drift reduction fan-type nozzle.	Bell Shaped Fan 
Drift-guard Flat Fan	Weed and brush control.	10–40 psi	Special drift reduction fan-type nozzle.	Bell Shaped Flat Fan 
Turbo-flood	Preemergence and postemergence herbicides where drift is a factor.	10–40 psi	Special drift reduction flooding-type nozzle with improved distribution with improved distribution uniforming	Wide Angle Bell Shaped 

Type	Spray Angle	Recommended Pressure (psi)	Spacing (inches)	Boom Height (inches)	Orientation	Recommended Spray Overlap
Flat Spray	65°	10–30	20"	21–23	Vertical	30–50%
	73°	10–30	20"	20–22		
	80°	10–30	20"	17–19		
	110°	10–30	30"	13–15		
Even Spray	80°	15–30	Row Spacing	5"= 8" band 6"=10" band 7"=12" band 8"=14" band	Vertical	Never
Cone	40°–110°	60 and above	As required for adequate foliar application.			
Flooding Spray	100°–145°	8–20	40"	12–15	Spray discharged 30°–45° from horizontal	100%
	100°–145°	8–20	60"	18–22		
	100°–145°	8–20	120"	36–45		
Raindrop®	80°–140°	20–60	20"	15–30	Spray discharged 30°–45° from horizontal	50–100%
	80°–140°	20–60	30"	16–31		
Whirl Jet®	120°–140°	5–20	30"	10–11	Spray discharged 30°–45° from horizontal	80–160%
	120°–140°	5–20	40"	14–15		

## Dusters and Granular Applicators

### Hand Dusters

Like hand sprayers, hand dusters can be used around homes and in gardens. They may consist of a squeeze bulb, bellows, tube, or shaker, a sliding tube, or a fan powered by a hand crank.

**Advantages:**

- the pesticide is ready to apply, and
- good penetration in confined spaces.

**Limitations:**

- high cost for pesticide,
- hard to get good foliar coverage, and
- dust is subject to drifting.

### Power Dusters

Power dusters use a powered fan or blower to propel the dust to the target. They range from knapsack or backpack types to those mounted on or pulled by tractors. Their capacity in area treated per hour compares favorably with some sprayers.

**Advantages:**

- simply built,
- easy to maintain, and
- low in cost.

**Limitations:**

- drift hazards,
- high cost of pesticide, and
- application may be less uniform than with sprays.

---

## Application

---

## Equipment

---

---

---

### Selecting a Duster

Look for a power duster that is easy to clean. It should give a uniform application rate as the hopper is emptied. Look for both hand and power dusters that keep the dust cloud well away from the user.

### Granular Applicators

These include hand-carried knapsack and spinning disk types for broadcast coverage, mounted equipment for applying bands over the row in row crops, and mounted or tractor-drawn machines for broadcast coverage.

#### *Advantages:*

- eliminates mixing,
- minimizes drift, and
- is less hazardous to applicator.

#### *Limitations:*

- high cost for pesticide,
- limited use against some pests because granules won't stick to most plants,
- need to calibrate for each granular formulation, and
- poor lateral distribution, especially on side slope.

### Selecting a Granular Applicator

Choose a granular applicator that is easy to clean and fill. It should have mechanical agitation over the outlet holes. This will prevent bridging and keep flow rate constant. Application should stop when drive stops even if outlets are still open.

### Use and Maintenance

Both dusters and granular applicators are speed-sensitive, so maintain uniform speed. Do not travel too fast for ground conditions. Bouncing equipment will cause the application rate to vary. Stay out of any dust cloud that may form.

Watch banders to see that band width stays the same. Small height changes due to changing soil conditions may cause rapid changes in band width.

Clean equipment as directed by the operator's manual.

## Controlling Drift

Drift is one of the major problems facing the application of agricultural chemicals. In addition to the potential damage to non-target areas, drift tends to reduce the effectiveness of chemicals and waste money. Drift is generally inconsistent with pesticide labeling and is a violation of state and federal laws. There are two different types of drift.

### Vapor Drift

Vapor drift occurs when a chemical vaporizes after being applied to the target area. The vapors are then carried to another area where damage may occur. The amount of vaporization that occurs depends largely on the temperature and formulation of the chemical being used. Volatile ester formulations vaporize rapidly as low as 65°F, while the "low volatile" esters resist vaporization up to 85–100°F. The amine formulations are referred to as "non-volatile." Thus by choosing the correct herbicide formulations, the dangers of vapor drift can be reduced substantially.

### Physical Drift

Physical drift is the actual movement of spray particles away from the target area. Many factors affect physical drift, but one of the most important is droplet size. Small droplets fall through the air much more slowly, so they are carried farther by air movement. The particle may be trapped in a temperature inversion and carried for a great distance if weather conditions are unfavorable. In addition, evaporation has a greater effect on the smaller droplet, which in turn slows the settling rate and creates still more opportunity for drift. The end result is that the carrier in some of the smaller particles evaporates completely before reaching the ground.

All nozzles produce a wide range of droplet sizes, and the very small, drift-prone particles cannot be eliminated completely. However, there are

several things that can be done to minimize unwanted physical drift.

First of all, use adequate amounts of carrier, usually 15–20 gallons per acre. This has several benefits from the standpoint of drift control. With lower concentrations, more drift droplets will be necessary to produce ill effects. In addition, more carrier means larger nozzles, which in turn usually produce larger droplets. Although this will increase the number of refills, the added carrier may also improve coverage and increase the effectiveness of the chemicals.

Avoid high pressures. A higher pressure creates a finer spray, which is more subject to drift. Forty psi should be considered maximum pressure for flat fan, even fan, and flooding nozzle tips. For maximum drift control with flooding nozzle tips, operate within the 8–20 psi pressure range (see table 1).

Use a flooding nozzle where practical. The flooding nozzle produces larger droplets and operates at lower pressure than the equivalent tapered fan nozzle. Special **low drift** hollow cone, flat fan, and flooding nozzles are claimed to greatly reduce the number of fine particles.

Numerous drift-reducing spray additives are available today, although their effectiveness generally has not been thoroughly tested. Foams and invert emulsions also have potential, although special equipment is usually required.

**Extreme care should be exercised to avoid drift away from the target area. Either physical drift or vapor drift can cause damage and expose the applicator to civil liability and possible criminal charges**

---

## Application

---

## Equipment

---

---

---



---

# Calibration

---

---

---

---



Calibration is simply a process to adjust your equipment to apply the desired rate of pesticide. This process is needed to insure that each pesticide is applied as directed on the label. Too much pesticide is dangerous; too little will not do a good job. Only by correct calibration can the best results be obtained.

Accurate calibration is the only way to know how much chemical is being applied.

Failure to calibrate a sprayer can injure crops, create hazardous situations, and cost money in wasted chemical. In addition to calibrating the sprayer at the start of the season, it should be recalibrated every few days of use. Tests have shown that wettable powders can wear nozzle tips enough to increase the discharge rate by 20 percent after spraying for only ten hours. Also, some brand new nozzles show a tendency to “wear in” and increase discharge by a few percent during the first hour or two.

Before calibrating, check the sprayer carefully. Be sure that nozzle tips are clean. Is pressure holding constant?

When the sprayer is operating properly, proceed to calibrate. There are many techniques for calibrating a sprayer, but they are all based on determining the volume of chemical applied to a measured area of land. Two methods are given for sprayers and one method is given for granular applicators. The choice between the two sprayer methods will depend on the type of equipment to be calibrated as well as personal preference. Use these or another method, but **CALIBRATE**.

## Sprayers

To apply a pesticide evenly and accurately, the sprayer must move at a constant speed and operate at a constant pressure. Each nozzle must be clean and at the right height. All nozzles must be of the correct type and

size for the job. Each nozzle in the system must deliver its rated amount.

## Measured Course and Banding

1. Measure off a distance of  $\frac{1}{8}$ -mile (660 feet or 40 rods). It is best to run the test in the field that will be sprayed, since sinkage in a soft field can change travel speed.
2. Start with a full spray tank, and be sure to eliminate air pockets in the pump, lines, and tank. Water (or the usual carrier) will usually do for calibration, but if you are using a chemical that changes the viscosity of the carrier, you should use the chemical as it will be sprayed.
3. Spray the  $\frac{1}{8}$ -mile strip, using the gear and throttle setting that you will use while spraying. You should run the engine well into the governed rpm range so that the governor can hold the speed constant.
4. Measure carefully the amount of water needed to refill the tank. Again, be careful to eliminate air pockets in the tank.
5. Calculate the application rate as follows:

$$\text{Broadcast—} \frac{\text{Gallons Used} \times 66}{\text{Swath width in ft.}} = \text{Gallons per treated acre}$$

$$\text{Banding—} \frac{\text{Gallons Used} \times 66}{\text{Band width in ft.} \times \text{Number of Bands}} = \text{Gallons per treated acre}$$

6. Divide tank capacity by gallons per acre determined in step 5. This gives the number of acres covered by one tankful of spray.
7. To determine the amount of chemical to add to each tank, multiply the recommended rate of application by the number of acres covered per tankful.

## Calibration Jar

1. With the tractor stationary, operate the sprayer at the same pressure that will be used in the field. Use clean water for calibration unless you are using a chemical that changes the viscosity of the water. Hold a one-quart jar under each nozzle and measure the number of seconds needed to fill the jar.

2. Calculate the flow rate of each nozzle by the formula:

$$\text{G.P.M.} = \frac{15}{S}$$

Where :

G.P.M. = Gallons per minute delivered by nozzle

S = Number of seconds needed to fill quart jar

3. Average the nozzle flow rates as determined in Step 2. Compare the flow rate of each individual nozzle tip with the average. Any tip that has flow rate more than  $\pm 5\%$  different than the average should be replaced. If the average flow rate differs from the factory specifications for new tips by more than  $\pm 5\%$ , then the entire set of nozzle tips should be replaced.
4. Measure a distance of 176 feet and time the tractor over that distance while operating at the same gear and rpm that will be used in the field. If possible, do this in the actual field to be sprayed so the sinkage will be constant.
5. Determine the speed of the tractor in miles per hour from the formula:

$$\text{MPH} = \frac{120}{T}$$

Where:

MPH = Speed of tractor in miles per hour

T = Number of seconds needed to travel 176 feet

6. Now, determine the application rate from the formula:

$$\text{G.P.A.} = \frac{\text{G.P.M.} \times 5,940}{\text{MPH} \times W}$$

Where:

G.P.A. = Application rate in gallons per acre (treated area)

G.P.M. = Gallons per minute delivered by nozzle

MPH = Speed of tractor in miles per hour

W = Width

(a) For broadcast spraying, W is nozzle spacing in inches

(b) For band spraying, W is band width in inches

7. Divide tank capacity by the gallons per acre determined in step 6. This gives the number of acres covered by one tankful of spray.
8. To determine the amount of chemical to add to each tank, multiply the recommended rate of application by the number of acres covered per tankful.

## Calibration Nomograph

The nomograph eliminates the calculations usually required to calibrate a sprayer. Needed are a quart jar, funnel, tape measure, watch with a sweep second hand, pencil and a straight edge. This procedure is **not** adapted to sprayers with ground driven, positive displacement pumps. The only other requirement is that the speed, nozzle spacing, and nozzle flow rate fall within the limits shown on the scales of the graph.

## Procedure

1. Operate the sprayer standing still with plain water (or the usual carrier) in the tank. Use the normal engine speed and pressure settings. Use a funnel to catch the flow from one nozzle in a quart jar. Determine the length of time (in seconds) needed to fill the quart jar. Repeat this for all nozzles and average the results. Replace any nozzles that vary more than  $\pm 5\%$  from the average.
2. Measure a distance of 176 feet, and determine the length of time (in seconds) needed to cover the 176 feet distance. This should be done with the same gear and throttle setting as will be used

---

## Calibration

---

---

---

---

- for spraying. If possible, do this in the field that will be sprayed so that sinkage will be nearly constant.
3. Measure the swath width of each nozzle. For boom spraying where the total area is covered, this is the nozzle spacing in inches. For band spraying, this is the band width in inches.
  4. Now, refer to the nomograph on page 89. Draw a straight line from the "seconds to travel 176 feet" to the "nozzle spacing in inches."
  5. Locate the point where your first line crosses the pivot line. Draw second straight line from that point to the "seconds to fill quart jar" using the average determined in step 1.
  6. Read "Gallons per Acre" from the appropriate scale.

**Example** (Shown in dashed lines) A field crop sprayer is equipped with nozzles that fill a quart jar in **50** seconds at the usual spraying pressure. The sprayer covers the distance of 176 feet in **24** seconds. Nozzle spacing is **20** inches. When operated under these conditions, the sprayer will deliver **17.8** gallons per acre.

**Note:** For a more thorough discussion of sprayer components, nozzle selection and calibration, refer to Extension Bulletins FM-13, "Understanding Your Sprayer," and AF-20, "Selecting the Right Sprayer Nozzle."

### Adjusting Your Sprayer

If the sprayer is delivering more or less spray than the label directs, you can change the rate three ways:

- Change the pressure. Lower pressure means less spray delivered; higher pressure means more spray delivered. This is not a good method, because a pressure change may change the nozzle pattern and droplet size. Pressure must be increased 4 times to double the output.

- Change the speed of your sprayer. Slower speed means more spray delivered, faster speed means less spray delivered. This method is practical for small changes in delivery rate. If you drive half as fast, you double the delivery rate.
- Change the nozzle tips to change the amount delivered. The larger the hole in the tip, the more spray delivered. This is the best method for making major changes in the delivery rate of sprayers. Always select proper nozzles for the job. Use the manufacturer's performance charts to make the selection.

After making a change, recalibrate to make sure the rate is correct.

### Determining the Correct Dosage

Next, the correct amount of pesticide to put in the tank to apply the correct dosage must be determined. To do this you need to know two more facts:

1. How much the sprayer tank holds.
2. The amount of formulation to be used per unit of area. This will be given on the label.

Suppose the tank holds 200 gallons of spray. The directions say to apply one pint of formulation on each acre, and the sprayer applies 20 gallons per acre. First find the number of acres one tank load will spray. Divide 200 gallons by 20.

$$\frac{200 \text{ gallons per tankful}}{20 \text{ gallons per acre}} = 10 \text{ acres per tankful}$$

To find the amount of formulation to add to the tank for spraying 10 acres with one pint per acre, multiply 1 pint by 10.

$$1 \text{ pint per acre} \times 10 \text{ acres per tankful} = 10 \text{ pints per tankful.}$$

Suppose the formulation of a pesticide is a 50 percent wettable powder and you want to apply  $\frac{1}{2}$  pound of active ingredient per acre. In this example the tank will cover 10 acres.

Calibration Nomograph

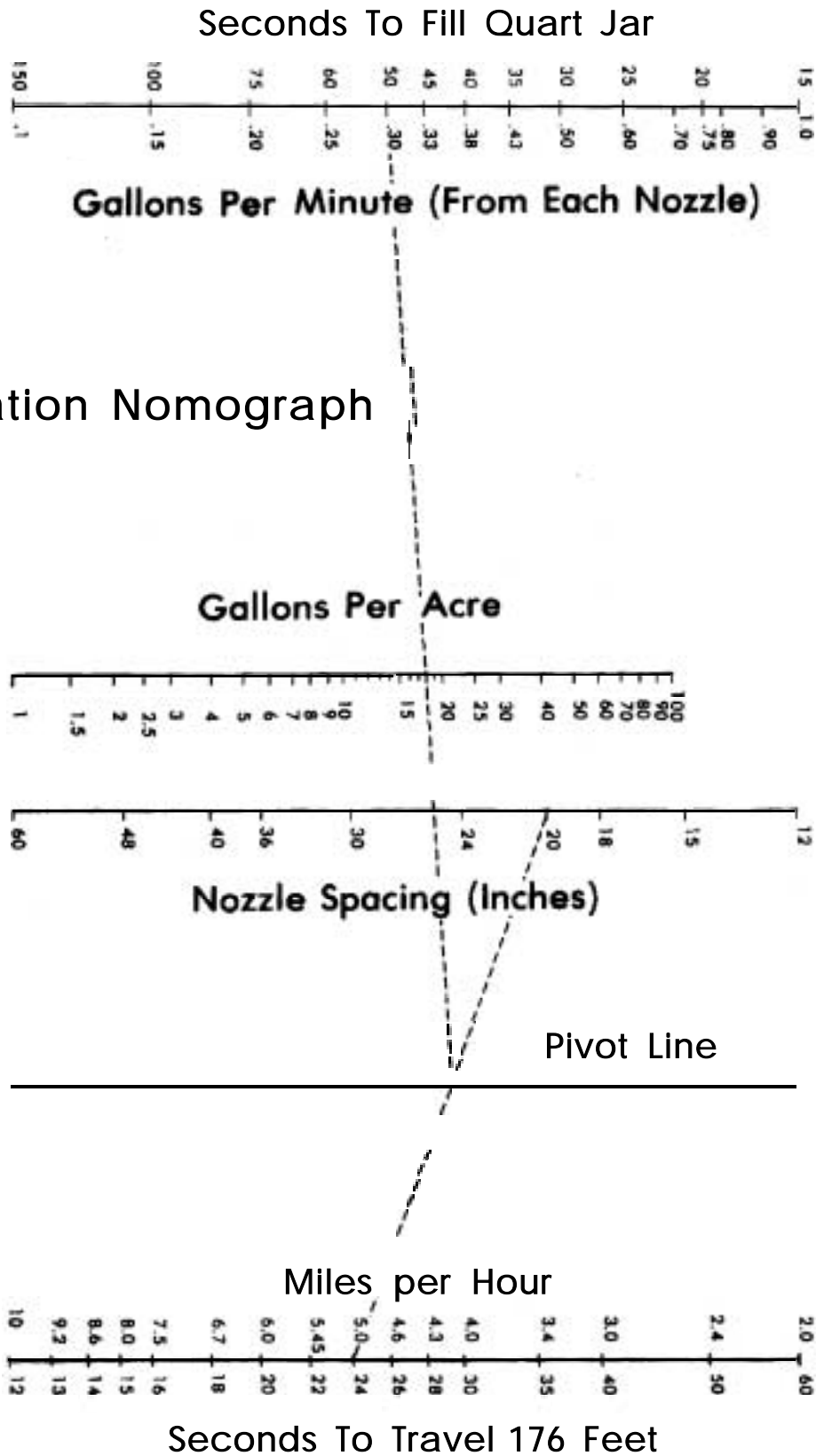

## Calibration

Find how many pounds of formulation are needed to apply  $\frac{1}{2}$  pound of active ingredient per acre. There is  $\frac{1}{2}$  pound of active ingredient in 1 pound of 50 percent wettable powder formulation. So 1 pound of formulation is needed for each acre your sprayer will cover.

$$1 \text{ pound per acre} \times 10 \text{ acres per tankful} \\ = 10 \text{ pounds per tankful.}$$

Add the 10 pounds of wettable powder to a small amount of water in a clean bucket. Stir until it is mixed well and add this mixture (called a slurry) to the partly filled tank. Remember to operate the sprayer's agitator while adding the slurry and filling the tank.

### Granular Application Calibration

Granular chemicals for weed or insect control must be applied with precision. This is particularly true of pre-emergence herbicides and soil insecticides.

Both herbicides and insecticides may be broadcast before planting or applied after planting. It is common, however, to apply those chemicals in a band over the row by attaching applicators to the planter. This reduces the amount of material used and thus lowers costs.

### Check and Maintain Ground Speed

Speed should be checked carefully in the field where the chemicals will be applied. One method is to set markers 176 feet apart and check the time (in seconds) required to drive between them. Make each check with a running start. To determine the speed in miles per hour, divide 120 by the traveling time in seconds. Some examples are given in the following table.

Once the field speed has been established and checked, keep the speed uniform during the application.

Even though granular applicators use a rotating agitator that varies with ground speed, the flow of the

granules through the outlet hole is not necessarily proportional to speed. It is not uncommon to find a 100 percent variation in the application rate with a speed change of 1 mile per hour.

The factors that affect application rate can vary from one day to the next or from one field to another. For this reason, check the application rate often so the necessary adjustments to obtain the proper application rate can be made.

### Field Check of Application Rate

Once the applicators have been set according to the operator's manual, make a field check for each hopper. This can be done in several ways. One method is to make a round or two in the field with the seed boxes removed from the planter. Paper, plastic, or cloth bags can be used for collecting the granules from each hopper. The granules collected can be weighed or checked with a calibrated measure. Repeat this process until the desired rate is obtained from each hopper.

Another method that is less accurate but still acceptable is to proceed with the planting and check the exact amount dispensed through each hopper. The disadvantage of this method is the possibility of not having the proper application rate on the calibrating rows.

The table at right shows the number of feet of row in 1 acre, and the pounds per acre to equal 1 ounce per 1,000-foot row. The table can be used to check calibration.

### Example 1

It is desired to apply a granular insecticide with units mounted on a 6-row 30-inch planter. The insecticide calls for 6 to 8 ounces per 1,000 feet of row. Four passes were made across a quarter section and the operator refilled all the hoppers. Refilled, they held a total of 20 pounds of insecticide. Is this within the allowable range?

**Table: Field Speed Determination**

Time required to drive 176 feet (seconds)	Speed (miles per hour)
60	2
40	3
30	4
24	5
20	6
17	7



**Solution:**

The total row length covered is: 4 passes × 6 rows × 2,640 feet = 63,360 feet, so the application rate is:

$$\frac{20 \text{ pounds} \times 16 \text{ ounces/pound}}{63.36 \text{ thousand feet}} = \frac{5.05 \text{ oz.}}{1,000 \text{ ft.}}$$

The application rate is too low, so the applicator should be readjusted.

**Example 2**

An applicator refilled his granular hoppers after finishing a 9-acre field and found that he had applied 75 pounds of granules. The label calls for 5 to 7 ounces per 1,000 feet of row. He is using 24-inch rows. Is he within the allowable range?

**Solution:**

The application rate in lbs/acre is:

$$\frac{75 \text{ pounds}}{9 \text{ acres}} = 8.33 \text{ lbs/acre}$$

From the table, 1 oz./1,000' = 1.36 lb./ac, so the row application rate was:

$$\frac{8.33 \text{ lb/ac}}{1.36 \text{ lb/ac}} = 6.125 \text{ oz./1,000'}$$

The application rate was acceptable.

**Example 3**

A patch of weeds about 80 feet in diameter needs to be treated for a noxious weed. The granular herbicide being used should be applied at the rate of 2 pounds per square rod. How much should be broadcast on this area?

**Solution:**

1 rod = 16.5 feet, so one sq. rod = 272 sq. ft.

The area of a circle is:

A = 3.14 × r × r, where r is the radius of the circle.

In this case, r = 40', so:

A = 3.14 × 40 × 40 = 5,024 square feet, or

$$\frac{5,024 \text{ sq. ft.}}{272 \text{ sq. ft./sq. rod}} = 18.5 \text{ sq. rd.}$$

So, the total amount applied should be: 2 lbs./sq. rd. × 18.5 sq. rd. = 37 lbs.

**Volume and Area Determinations**

**Determining Volume**

Volume of a Cylinder = 3.1416 × radius × radius × length.

Volume of a Cone × 1.0472 × radius × radius × height (i.e. round hopper bottom).

Volume of a Pyramid = length of base × width of base × 1/3 of the height (i.e. square hopper bottom).

**How much is in the tank?**

Cylindrical spray tanks are often mounted horizontally, but unless the tank has a capacity scale taped to it, it is hard to calculate how much liquid is left in the tank.

The first question is "What is the total capacity of the tank?" The volume of a cylindrical tank is:

$$V = 3.1416 \times R \times R \times L$$

This assumes the end of the tank is flat, not oval or spherical. For example, if the tank diameter is 36 inches and the length is 48 inches, the volume is:

$$V = 3.1416 \times 18 \times 18 \times 48 = 48,858 \text{ cubic inches}$$

Since one gallon contains 231 cubic inches, the tank capacity in gallons is:

$$\frac{48,858}{231} = 211.5 \text{ gallons}$$

Now, if the tank is only partially filled, how much does it contain? To determine this, with the tank level, measure the depth of the liquid, then consult the graph below. Considering the same tank (36 inch × 48 inch) as above, assume the liquid depth is 9 inches. Then, d/D X 100 becomes 9/36 × 100 or 25. Reading up from the bottom axis, then over, the graph indicates that the tank is 20 percent full, or 20 percent × 211.5 gallons equals 42.3 gallons.

**Volume Conversion Factors:**

- 1 gallon = 231 cu. in.
- 7.48 gallons = 1 cu. ft.
- 62.4 pounds of water = 1 cu. ft.
- 8.336 pounds of water = 1 gallon
- 1 gallon = 0.1337 cu. ft.
- 27 cu. ft. = 1 cu. yd.

Row Spacing	Feet of Row in 1 Acre	lbs/ Acre to Equal 1 oz. per 1,000 ft. of Row
40	13,068	.82
36	14,520	.91
30	17,424	1.09
24	21,780	1.36
20	26,136	1.63

# Calibration

## Determining Field Areas

Area of a Rectangle = length  $\times$  width

Area of Right Triangle =  $\frac{1}{2} \times$  length  $\times$  width

Area of a Circle =  $3.14 \times$  radius  $\times$  radius

## Area Conversion Factors:

Acres = sq. ft./43,560

miles = ft./5,280

miles = rods/320

rods = ft./16.5

## Example 1

An operator filled a 300 gallon spray tank and started spraying a half section. He ran out in the middle

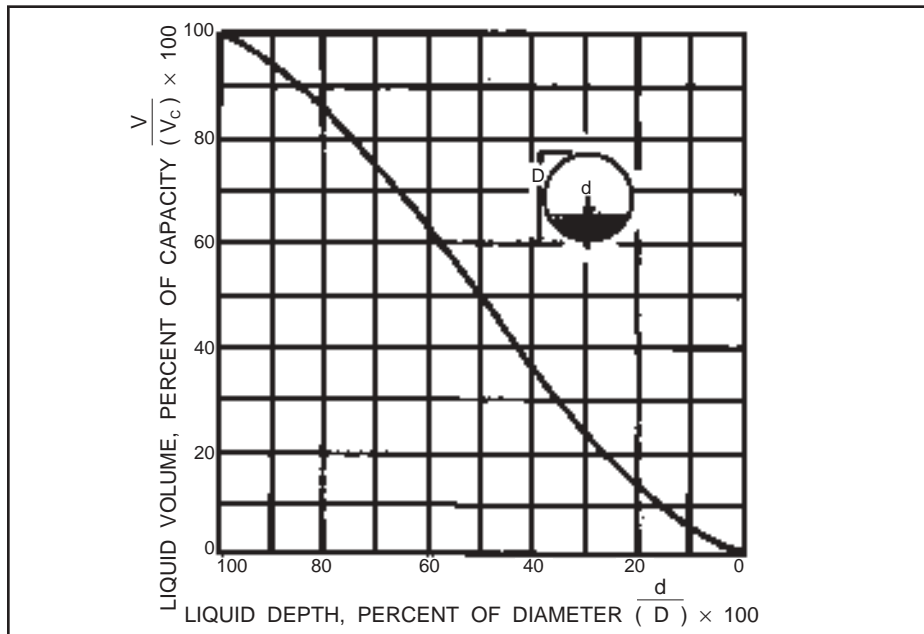

Depth-Volume "Graph"

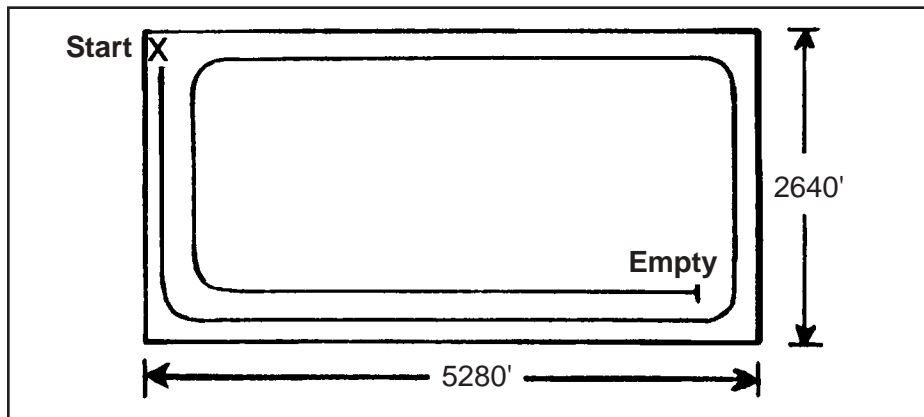

of the second round. Swath width is 30 feet. How many gallons per acre are being applied?

## Solution:

First, calculate the area sprayed. In this case, the top and bottom strips are 5,280 feet long, while the end strips are  $2,640 - 90 = 2,550$  feet long.

Thus, the areas sprayed are:

Top:  $30' \times 5,280' = 158,400$

Bottom:  $60' \times 5,280' = 316,800$

Left:  $60' \times 2,550' = 153,000$

Right:  $30' \times 2,550' = 76,500$

TOTAL 704,700 ft<sup>2</sup>

Now to convert square feet to acres:

$$\frac{704,700 \text{ ft}^2}{43,560 \text{ ft}^2 / \text{acre}} = 16.18 \text{ acres}$$

So the application rate is:

$$\frac{300 \text{ gallons}}{16.18 \text{ acres}} = 18.5 \text{ gallons/acre}$$

## Example 2

A creek runs through an 80 acre field, cutting a large corner off. The east and west boundaries are  $\frac{1}{2}$  mile and  $\frac{1}{8}$  mile long, and the south fence is  $\frac{1}{4}$  mile long. The creek is nearly straight. A 25' wide sprayer makes 30 passes, starting at the west edge, and about 340 gallons of spray is used. What is the application rate?

## Solution:

To solve the problem, first divide the sprayed area into two regions, a rectangle and a triangle.

Rectangle (Region 1)

$$\text{Area} = 30 \text{ passes} \times 25' \times 660' = 495,000 \text{ ft}^2$$

( $\frac{1}{8}$  mile = 660 feet)

Triangle (Region 2)

$$\text{Area} = \frac{1}{2} \times W \times X$$

$$\text{Now, } Z = \frac{1}{2} - \frac{1}{8} = \frac{3}{8} \text{ mile} = 1,980'$$

$$W = 750'$$

Since the creek is nearly straight: X is the same proportion of Z as W is to  $\frac{1}{4}$  mile. Thus,

## Calibration

---



---



---



---

$$X = \frac{W}{\frac{1}{4} \text{ mile}} \times Z$$

or

$$X = \frac{750}{1,320} \times 1,980 = 1,125'$$

So Area =  $\frac{1}{2} \times 750 \times 1,125 = 421,875$  and the total area sprayed is:

$$495,000 + 421,875 = 916,875 \text{ ft}^2$$

or

$$\frac{916,875 \text{ ft}^2}{43,560 \text{ ft}^2/\text{acre}} = 21.05 \text{ acres}$$

Since 340 gallons were used, the application rate is:

$$\frac{340 \text{ gal.}}{21.05 \text{ acre}} = 16.2 \text{ gallons/acre}$$

### Example 3

A sprayer starts spraying a  $\frac{1}{4}$  section sized center pivot irrigated field. At the end of the third round, he has used about 320 gallons of spray. He is using a 30 foot boom. What is the application rate?

#### Solution:

A 90 feet wide strip was sprayed around the outside of the circle, so we can calculate the total area of the circle, then subtract the area that has not yet been sprayed.

Total area of circle:

$$A = 3.14 \times 1,320 \times 1,320 = 5,471,136 \text{ ft}^2$$

or

$$\frac{5,471,136 \text{ ft}^2}{43,560 \text{ ft}^2/\text{ac}} = 125.6 \text{ acres}$$

Area not yet sprayed

$$r = 1,320 - 90 = 1,230'$$

$$A = 3.14 \times 1,230 \times 1,230 = 4,750,506 \text{ ft}^2$$

or

$$\frac{4,750,506 \text{ ft}^2}{43,560 \text{ ft}^2/\text{ac}} = 109.1 \text{ acres}$$

So, the area that has been sprayed is  $125.6 - 109.1 = 16.5$  acres, and the application rate is:

$$\frac{320 \text{ gallons}}{16.5 \text{ acres}} = 19.4 \text{ gallons/acre}$$

### Useful Conversions

$$\text{MPH} \times \text{ft} / \text{min} / 88$$

$$\frac{\text{Acres/}}{\text{Hour}} = \frac{\text{MPH} \times \text{swath width (ft)}}{8.25}$$

$$\frac{\text{Acres/}}{\text{Minute}} = \frac{\text{MPH} \times \text{swath width (ft)}}{495}$$

Example: A 20 foot sprayer traveling 6 MPH covers 14.5 acres/hour. A 100 MPH airplane with a 50 foot swath covers 10.1 acres/minute.

3 teaspoons = 1 tablespoon

2 tablespoons = 1 fluid ounce

8 fluid ounces = 1 cup

2 cups = 1 pint

2 pints = 1 quart

4 quarts = 1 gallon

1 pint = 473 milliliters

1 gallon = 3,785 milliliters

1 pound = .454 kilograms

1 liter of water weighs 1 kilogram

1,000 milliliters = 1 liter

1,000 grams = 1 kilogram

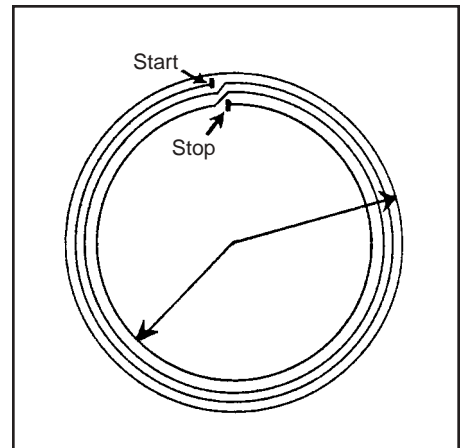
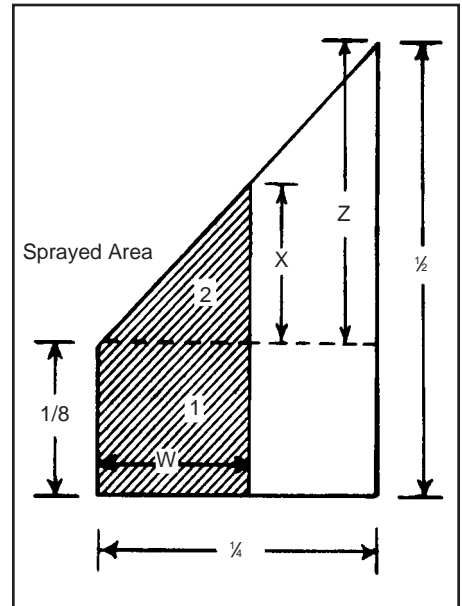

---

# Laws and Regulations

---

---

---



Without pesticides, we would not have the food, fiber, and landscape plants we need. But because pesticides can be dangerous, Congress has passed laws affecting pesticide use. These laws try to balance the need for pesticides against the need to protect people and the environment from their misuse.

## Federal Insecticide, Fungicide, and Rodenticide Act (FIFRA) as Amended

You are taking this training because of a law passed by Congress in 1972. It is often called by its initials—FIFRA. It requires you to show that you know the correct way to use and handle pesticides.

Here are the parts of the law which concern you the most:

- It says that all pesticide uses must be *classified* as either general or restricted,
- It requires you to be *certified* as competent to use any of the pesticides classified for restricted use,
- It makes it a crime to use any pesticide in a manner inconsistent with its labeling, and
- It provides *penalties* (up to \$1000 and 30 days in prison) for people who do not obey the law.

### Classification of Pesticides

Manufacturers must register every pesticide with EPA. By regulation, when each pesticide is registered, all its uses must be classified. EPA must decide whether each use is a general or a restricted one.

Under the law, pesticide uses that will damage the environment very little or not at all when done as the label directs can be classified as *general uses*.

Uses that could cause damage, even when done as directed on the label, must be classified as *restricted uses*. They may be carried out only:

- by someone who is certified, or
- under a certified person's supervision.

Some uses may be general under some conditions and restricted under others.

### Prohibited Actions

The law names many things you cannot do. These two concern you most:

- You may not use a pesticide other than as the label or labeling directs, except when special regulations allow you to—use it for other pests or at a lower rate than the label recommends.
- You may not dispose of any pesticide or its container except as the label or labeling directs.

You also should know your State and local laws. They may prohibit more actions than the Federal law does.

The applicator is responsible for proper pesticide use and empty container disposal.

### Residues

The pesticide that stays in or on raw farm products or processed foods is called a *residue*. EPA sets residue tolerances under regulations authorized by the Federal Food, Drug, and Cosmetic Act. A tolerance is the concentration of a pesticide that is judged safe for human consumption. Residues in processed foods are considered to be food additives and are regulated as such.

Tolerances are expressed in “parts per million” (ppm). One ppm equals one part (by weight) of pesticide for each million parts of farm or food product. Using pounds as a measure, 50 ppm would be 50 pounds of pesticide in a million pounds of the product. The same pesticide may have a different tolerance on different products. It might be 50 ppm on grapes and 25 ppm on apples.

If too much residue is found on a farm or food product, the product may be seized or condemned.

The label will tell you how many days before harvest the pesticide may be applied. Follow the label exactly. Then you can be sure you are not breaking the law.

### Restricted Use Pesticide Application Recordkeeping Requirements

Private applicators must record their restricted use pesticide (RUP) applications, as required by the Food, Agriculture, Conservation and Trade (FACT) Act of 1990. The USDA Agricultural Marketing Service administers this activity. However, for good management, recordkeeping is strongly encouraged for ALL pesticide applications.

Each pesticide application requires an individual record. RUP application records may be handwritten on individual notes or forms, consist of invoices, be computerized, and/or maintained in recordkeeping books.

RUP application records must be maintained for two years from the date of application. The certified pesticide applicator should retain these RUP records, but must be able to make them accessible for copying by authorized representatives.

Your records must include:

- Brand/product name
- EPA registration number
- Total amount of RUP applied
- Location of application
- Size of area treated
- Crop, commodity, stored product, or site treated
- Application date (month/day/year)
- Name of certified applicator
- Certification number

### Spot Treatments

RUP applications made on the same day in a total area of less than one-tenth of an acre require the following information to be recorded:

- Brand/product name
- EPA registration number
- Total amount applied

- Location must be designated "spot treatment"
- Date of application

A commercial applicator must, within 30 days of an RUP application, provide a copy of the required records to the person for whom the RUP was applied. However, certified commercial applicators can hold these RUP application records for their clients as long as the client has signed a statement recognizing the commercial applicator as the record holder. Commercial applicators should provide their clients with a copy of the signed statement, make these records available to their clients upon request, and maintain separate records for each client.

### The Kansas Pesticide Law

The State of Kansas, under the Kansas Pesticide Law, has been granted primacy by the Federal Government. This primacy says, in effect, that the State has jurisdiction over all pesticide matters. Primacy allows the state to adopt rules and regulations regarding pesticide use that must meet Federal standards. However, the state regulations may be more strict than the federal law. Pesticide users in Kansas should expect firm but fair enforcement of the Pesticide Law.

Criminal penalties under the Kansas Pesticide Law for violations by certified private applicators shall be expressed as a misdemeanor. Upon conviction, a violator shall be punished by a fine of not less than one hundred dollars (\$100) and not more than five hundred dollars (\$500).

Noncriminal penalties may also be assessed a certified private applicator. These penalties range from an administrative letter of warning to having one's certification denied, suspended, or revoked.

### Recordkeeping Requirements for Sales of Restricted Use Pesticides

Effective July 1, 1985, an amendment to the Kansas Pesticide Law requires persons selling Restricted Use



---

## Laws and Regulations

---

---

---

Pesticides to maintain, for a period of two years, records of the sales transaction of pesticides classified as Restricted Use.

The records for sales of Restricted Use Pesticides must contain the following information:

1. The name and address of the residence or principal place of business of each person to whom the restricted use pesticide product has been sold;
2. The name and address of the residence or principal place of business or the individual to whom the restricted use pesticide product has been delivered or made available if different from the purchaser;
3. The certification number of applicator's certificate;
4. The name of the state issuing the certificate;
5. The expiration date of the certificate;
6. If the applicator is a certified commercial applicator of pesticides, the categories and subcategories, if applicable, in which the applicator is certified;
7. The registered name of the restricted use pesticide product, its EPA registration number and the state special local need registration number, if any;
8. The quantity of the restricted use pesticide product sold; and
9. The date of the transaction.

A pesticide dealer may make a restricted use pesticide product available to an uncertified person for use (application) by the certified applicator if the following additional records are kept by the dealer:

1. The name and address of the residence or principal place of business of the uncertified person to whom the restricted use pesticide product has been made available; and
2. The name and address of the residence or principal place of business of the certified applicator who will use the restricted use pesticide product.

## Laws and Regulations in Regard to Wildlife Damage Control

Because of public attitudes about wildlife and information about bird, rodent, and predator biology, control actions are regulated beyond normal pesticide laws and regulations. Anyone intending to become involved in a wild animal damage problem should first learn of the laws and regulations related to the target species in the area of control action. Remembering control actions are designed to stop the damage, not necessarily to kill the offending animals.

### Some State Regulations to Consider Are As Follows:

A nuisance bird control permit shall be required to use any lethal method of control which involves poisons or chemicals for controlling nuisance birds. When a permit is required, nuisance birds killed and the plumage shall be utilized only in the manner specified in the permit. All nuisance bird control activities shall be subject to all federal and state laws and rules and regulations.

A permit is required from the Kansas Department of Wildlife and Parks to use any burrow fumigants. Burrow fumigants are used for prairie dog control and to a lesser extent for norway rats and 13 lined ground squirrels. The permit has to be recommended by the Extension Specialist, Wildlife Damage Control, at Kansas State University before the permit will be issued.

A permit is required from the Kansas Department of Wildlife and Parks to use a device referred to as M-44s. This device is used occasionally for coyote damage control, especially during the winter time. Sodium cyanide is the chemical agent used in the M-44. The permit has to be recommended by the Extension Specialist, Wildlife Damage Control, at Kansas State University.

---

Prior to any chemical prairie dog control effort, the label states that the prairie dog colony must first be searched for black-footed ferret signs and that no control can be carried out if this endangered species, the black-footed ferret, might be present as the sign indicates.

These are only a few of the related state laws and regulations which apply to wildlife damage control. Any person intending to conduct damage control involving a wildlife species should contact the Extension Wildlife Damage Control Office at Kansas State University or a Conservation Officer with the Kansas Department of Wildlife and Parks.

Federal laws that relate to wildlife damage control include, but are not limited to, the following.

1. Migratory Bird Treaty Act
2. Fish and Wildlife Coordination Act
3. Animal Damage Control Act of March 2, 1931
4. National Environmental Policy Act
5. Federal Insecticide, Fungicide and Rodenticide Act
6. Endangered Species Act
7. Bald Eagle Protection Act

---

## **Laws and Regulations**

---

---

---

---

# Terms Used In Pest Control

---

---

Some of these words have several meanings. Those given here are the ones that relate to pest control.

**Abrasion:** The process of wearing away by rubbing.

**Abscission:** The separation of fruit, leaves, or stems from a plant.

**Absorption:** The pricks by which a chemical is taken into plants, animals, or minerals. Compare with adsorption.

**Activator:** A chemical added to a pesticide to increase its activity.

**Adherence:** Sticking to a surface.

**Adjuvant:** Inert ingredient added to a pesticide formulation to make it work better.

**Adsorption:** The process by which chemicals are held on the surface of a mineral or soil particle. Compare with absorption.

**Adulterated:** Any pesticide whose strength or purity falls below the quality stated on its label. Also, a food, feed, or product that contains illegal pesticide residues.

**Aerobic:** Living in air. The opposite of anaerobic.

**Aerosol:** An extremely fine mist or fog consisting of solid or liquid particles suspended in air. Also, certain formulations used to produce a fine mist.

**Agitation:** The process of stirring or mixing in a sprayer.

**Alkaloids:** Chemicals present in some plants. Some are used as pesticides.

**Anaerobic:** Living in the absence of air. The opposite of aerobic.

**Animal Sign:** The evidences of an animal's presence in an area.

**Antagonism:** The loss of activity of a chemical when exposed to another chemical.

**Antibiotic:** A substance which is used to control pest microorganisms.

**Antidote:** A practical treatment for poisoning, including first aid.

**Aqueous:** A term used to indicate the presence of water in a solution.

**Arsenicals:** Pesticides containing arsenic.

**Aseptic:** Free of disease-causing organisms.

**Bait Shyness:** The tendency for rodents, birds, or other pests to avoid a poisoned bait.

**Botanical Pesticide:** A pesticide made from plants. Also called plant-derived pesticides.

**Broadleaf Weeds:** Plants with broad, rounded, or flattened leaves.

**Brush Control:** Control of woody plants.

**Carbamate:** A synthetic organic pesticide containing carbon, hydrogen, nitrogen, and sulfur.

**Carcinogenic:** Can cause cancer.

**Carrier:** The inert liquid or solid material added to an active ingredient to prepare a pesticide formulation.

**Causal Organism:** The organism (pathogen) that produces a specific disease.

**Chemosterilant:** A chemical that can prevent reproduction.

**Chlorinated Hydrocarbon:** A synthetic organic pesticide that contains chlorine, carbon, and hydrogen. Same as organochlorine.

**Chlorosis:** The yellowing of a plant's green tissue.

**Cholinesterase:** A chemical catalyst (enzyme) found in animals that helps regulate the activity of nerve impulses.

**Compatible:** When two or more chemicals can be mixed without affecting each other's properties, they are said to be compatible.

**Concentration:** The amount of active ingredient in a given volume or weight of formulation.

**Contaminate:** To make impure or to pollute.

**Corrosion:** The process of wearing away by chemical means.

**Crucifers:** Plants belonging to the mustard family, such as mustard, cabbage, turnip, and radish.

**Cucurbits:** Plants belonging to the gourd family, such as pumpkin, cucumber, and squash.

**Deciduous Plants:** Perennial plants that lose their leaves during the winter.

**Deflocculating Agent:** A material added to a suspension to prevent settling.

**Degradation:** The process by which a chemical is reduced to a less complex form.

**Dermal:** Of the skin; through or by the skin.

**Dermal Toxicity:** Ability of a chemical to cause injury when absorbed through the skin.

**Diluent:** Any liquid or solid material used to dilute or carry an active ingredient.

**Dilute:** To make thinner by adding water, another liquid, or a solid.

**Dispersing Agent:** A material that reduces the attraction between particles.

**Dormant:** Stale in which growth of seeds or other plant organs stops temporarily.

**Dose, Dosage:** Quantity of a pesticide applied.

**Economic Injury Level:** The lowest number of pests that will cause an amount of injury equal to the cost of applying control practices.

**Economic threshold:** Also called the action threshold; the pest number or density at which remedial control practices should be taken to prevent pests from exceeding the economic injury level.

**Emulsifier:** A chemical which aids in suspending one liquid in another.

**Emulsion:** A mixture in which one liquid is suspended as tiny drops in another liquid, such as oil in water.

**Fungistat:** A chemical that keeps fungi from growing.

**GPA:** Gallons per acre.

**GPM:** Gallons per minute.

**Growth Stages of Cereal Crops:**

(1) Tillering—when additional shoots are developing from the flower buds.

(2) Jointing—when stem internodes begin elongating rapidly. (3) Booting—when upper leaf sheath swells due to the growth of developing spike or panicle. (4) Heading—when seed head is emerging from the upper leaf sheath.

**Hard (water):** Water containing soluble salts of calcium and magnesium and sometimes iron.

**Herbaceous Plant:** A plant that does not develop woody tissue.

**Hydrogen-Ion Concentration:** A measure of acidity or alkalinity, expressed in terms of the pH of the solution. For example, a pH of 7 is neutral, from 1 to 7 is acid, and from 7 to 14 is alkaline.

**Immune:** Not susceptible to a disease or poison.

**Impermeable:** Cannot be penetrated. Semipermeable means that some substances can pass through and others cannot.

**Lactation:** The production of milk by an animal, or the period during which an animal is producing milk.

**LC<sub>50</sub>:** The concentration of an active ingredient in air which is expected to cause death in 50 percent of the test animals so treated. A means of expressing the toxicity of a compound present in air as dust, mist, gas, or vapor. It is generally expressed as micrograms per Liter as a dust or mist but in the case of a gas or vapor as parts per million (ppm).

**LD<sub>50</sub>:** The dose of an active ingredient taken by mouth or absorbed by the skin which is expected to cause death in 50 percent of the test animals so treated. If a chemical has an LD<sub>50</sub> of 10 milligrams per kilogram (mg/kg) it is more toxic than one having an LD<sub>50</sub> of 100 mg/kg.

**Leaching:** Movement of a substance downward or out of the soil as the result of water movement.

**Mammals:** Warm-blooded animals that nourish their young with milk. Their skin is more or less covered with hair.

**Miscible Liquids:** Two or more liquids that can be mixed and will remain mixed under normal conditions.

**MPH:** Miles per hour.

**Mutagenic:** Can produce genetic change.

**Necrosis:** Localized death of living tissue such as the death of a certain area of a leaf.

**Necrotic:** Showing varying degrees of dead areas or spots.

**Nitrophenols:** Synthetic organic pesticides containing carbon, hydrogen, nitrogen, and oxygen.

**Noxious Weed:** A plant defined as being especially undesirable or troublesome.

**Oral:** Of the mouth; through or by the mouth.

**Oral Toxicity:** Ability of a pesticide to cause injury when taken by mouth.

**Organic Compounds:** Chemicals that contain carbon.

**Organochlorine:** Same as chlorinated hydro-carbon.

**Organophosphate:** A synthetic organic pesticide containing carbon, hydrogen, and phosphorus; parathion and malathion are two examples.

**Ovicide:** A chemical that destroys eggs.

**Pathogen:** Any disease-producing organism.

**Penetration:** The act of entering or ability to enter.

**Phytotoxic:** Harmful to plants.

**Pollutant:** An agent or chemical that makes something impure or dirty.

**PPB:** Parts per billion. A way to express the concentration of chemicals in foods, plants, and animals. One part per billion equals 1 pound in 500,000 tons.

**PPM:** Parts per million. A way to express the concentration of chemicals in foods, plants, and animals. One part per million equals 1 pound in 500 tons.

**Predator:** An animal that destroys or eats other animals.

**Propellant:** Liquid in self-pressurized pesticide products that forces the active ingredient from the container.

**PSI:** Pounds per square inch.

**Pubescent:** Having hairy leaves or stems.

**Residual Activity:** Persistence of pesticide after application, usually in terms of continued effectiveness against targeted pests.

**Residue:** Quantities of a pesticide or pharmaceutical product that remains in or on food, feed, soil, water, or other substrate after application or contamination.

**Resistance:** The ability of an individual or population of plants or animals to withstand a physical or chemical challenge that is lethal to others of its kind. Such resistance is genetically conveyed to descendants. 1) Crop varieties are bred for resistance to diseases, insects, herbicides, or drought. 2) Populations of insects or weeds may become resistant to insecticides or herbicides through continual use of the same type of material which eliminates individuals most susceptible to that material and leaves resistant ones to dominate the population.

**RPM:** Revolutions per minute.

---

## Terms Used In

---

### Pest Control

---

---

---

**Safener:** A chemical added to a pesticide or seed to keep the pesticide from injuring the crop.

**Seed Protectant:** A chemical applied to seed before planting to protect seeds and new seedlings from disease and insects.

**Soil Sterilant:** A chemical that prevents the growth of all plants and animals in the soil. Soil sterilization may be temporary or permanent, depending on the chemical.

**Soluble:** Will dissolve in a liquid.

**Solution:** Mixture of one or more substances in another in which all ingredients are completely dissolved.

**Solvent:** A liquid which will dissolve a substance to form a solution.

**Spreader:** A chemical which increases the area that a given volume of liquid will cover on a solid or on another liquid.

**Sticker:** A material added to a pesticide to increase its adherence.

**Surfactant:** A chemical which increases the emulsifying, dispersing, spreading, and wetting properties of a pesticide product.

**Susceptible:** Capable of being diseased or poisoned; not immune.

**Susceptible Species:** A plant or animal that is poisoned by moderate amounts of a pesticide.

**Suspension:** Finely divided solid particles mixed in a liquid.

**Synergism:** The joint action of two or more pesticides that is greater than the sum of their activity when used alone.

**Target Pest:** The pest at which a particular pesticide or other control method is directed.

**Tolerance:** (1) The ability of a living thing to withstand adverse conditions, such as pest attacks, weather extremes, or pesticides. (2) The amount of pesticide that may safely remain in or on raw farm products at the time of sale.

**Toxicant:** A poisonous chemical.

**Trade Name:** Same as brand name.

**Vapor Pressure:** The property which causes a chemical to evaporate. The lower the vapor pressure, the more easily it will evaporate.

**Vector:** A carrier, such as an insect, that transmits a pathogen.

**Viscosity:** The property of liquids that determines whether they flow readily. Viscosity usually increases when temperature decreases.

**Volatile:** Evaporates at ordinary temperatures when exposed to air.

**Wetting Agent:** A chemical which causes a liquid to contact surfaces more thoroughly.



---

Frannie Miller  
Pesticide Coordinator

---

Authors: Don Cress, Former Pesticide Coordinator, Kansas State University  
Robert Bowden, Extension Specialist, Plant Pathology, Kansas State University  
H. Leroy Brooks, Extension Specialist, Insecticides (Pesticide Safety),  
Kansas State University  
F. Robert Henderson, Extension State Leader, Wildlife Damage Control  
Program, Kansas State University  
Randall Higgins, Extension State Leader, Entomology, Kansas State University  
Dennis K. Kuhlman, Extension Agricultural Engineer, Pesticide Application,  
Kansas State University  
Larry Leuthold, Extension Specialist, Turfgrass, Kansas State University  
Donald E. Mock, Extension Specialist, Livestock Entomology, Kansas State  
University  
Dallas E. Peterson, Extension Specialist, Weed Science, Kansas State University

Consulting Staff: Appreciation is expressed to the following for review of the  
material in this manual:  
Jerry Dreher, Ford County Extension Agent, Agriculture  
Dale Ladd, McPherson County Extension Agent, Agriculture and Community  
Development  
Art Johnson, Jefferson County Extension Agent, Agriculture  
Joe Smith, Montgomery County Extension Agent, Agriculture  
Rick Snell, Barton County Extension Agent, Agriculture

Acknowledgements: Appreciation is expressed to the following for coopera-  
tion in the Private Pesticide Applicator Training Program:  
Jeanne Fox, Ecological Specialist, Pesticide Use Section, Plant Health Division,  
Kansas Department of Agriculture  
Sue Ann Funk, Pesticide Use Section, Plant Health Division, Kansas Depart-  
ment of Agriculture  
Gary Boutz, Administrator, Pesticide Use Section, Plant Health Division,  
Kansas Department of Agriculture

Brand names appearing in this publication are for product identification purposes only. No endorsement is intended,  
nor is criticism implied of similar products not mentioned.

Publications from Kansas State University are available on the World Wide Web at: <http://www.oznet.ksu.edu>

Contents of this publication may be freely reproduced for educational purposes. All other rights reserved. In each case, credit Sharon M. Dobesh,  
et al., Private Pesticide Applicator Manual, Kansas State University, February 1997

Kansas State University Agricultural Experiment Station and Cooperative Extension Service  
MF-531 (Revised)

February 1997

It is the policy of Kansas State University Agricultural Experiment Station and Cooperative Extension Service that all persons shall have equal opportunity and  
access to its educational programs, services, activities, and materials without regard to race, color, religion, national origin, sex, age or disability. Kansas State  
University is an equal opportunity organization. Issued in furtherance of Cooperative Extension Work, Acts of May 8 and June 30, 1914, as amended. Kansas  
State University, County Extension Councils, Extension Districts, and United States Department of Agriculture Cooperating, Marc A. Johnson, Director.